

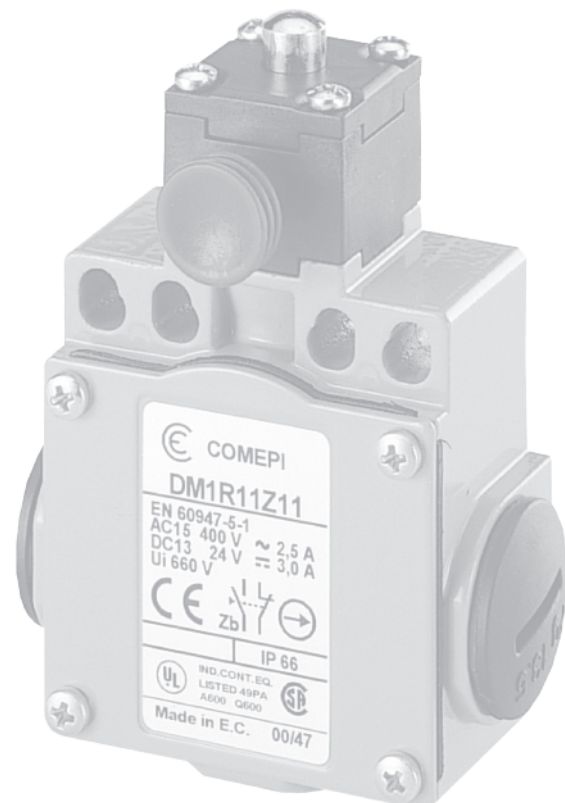

SAFETY LIMIT SWITCHES



Application

The Comepi limit switches are developed and manufactured according to the rules set out in IEC international publications and EN european standards.

Easy to use, electromechanical limit switches offer specific qualities:

- Visible operation.
- Able to switch strong currents (10 A conventional thermal current).
- Precise operating points (consistency).
- Immune to electromagnetic disturbances.
- Electrically separated contacts.
- N.C. contacts with positive opening operation (⊖).

Contact Blocks

Z11 Snap action
1NO+1NC

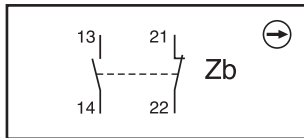

Z02 Snap action
2NC

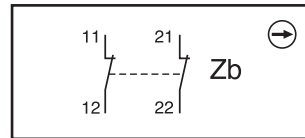

X11 Slow action break before
make 1NO+1NC

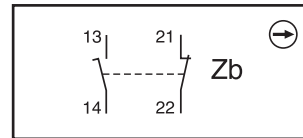

Y11 Slow action make before
break 1NO+1NC

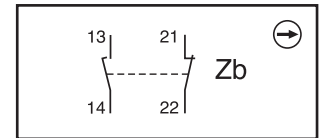

W02 Simultaneous slow action
2NC

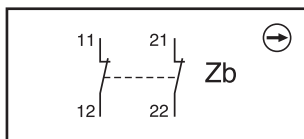

X21/X21P Slow action break
before make 2NO+1NC

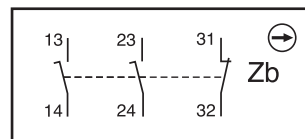

X12/X12P Slow action break
before make 1NO+2NC

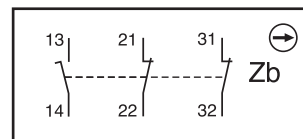

W03/W03P Simultaneous slow
action 3NC

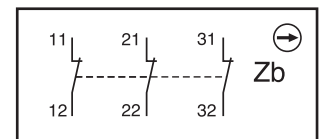

Main Technical Data

	SP, SBP, SDP series	SM, SBM, SCM, SDM series
Standards	IEC 947-5-1, EN 60947-5-1, UL 508, CSA C22-2 No 14	
Operating temperature range	-25°C... +70°C	
Protection against electrical shocks (acc. to IEC 536)	Class II	Class I
Protection degree (acc. to IEC 529)	IP65	IP 66
Rated insulation voltage (acc. to IEC 947-1)	$U_i = 690V$ (SM, SDM series and contacts type X12P, X21P, W03P series: $U_i = 400V$)	
Rated impuled withstand voltage (acc. to IEC 947-1)	$U_{imp} = 6kV$	
Short-circuit protection	Fuse 10A type gG (gl)	
Power category	A600 - Q600 (SM, SDM series and contacts type X12P, X21P, W03P: A300 - Q300)	
Rated operational current (acc. to IEC 947-5-1)	AC-15: 24V-10A; 230V-3,1A; 380V-1,9A DC-13: 24V-2,8A; 250V-0,27A	

Electrical connection

Replace the symbol with the number of the required thread

- 1: PG 13.5
- 2: 1/2" NPT (Through adapter on SP and SDP series)
- 3: PG 11 (Available on SP, SM, SDP and SDM series)
- 4: M16x1,5 (Available on SP, SM, SDP and SDM series)
- 5: M20x1,5



K10

90° Adjustable head
(replaces K20)



K80

Fully turnable head
(replaces K120)

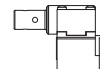

K71

Zinc plated steel shaft



K61

Zinc plated steel lever

K72

Stainless steel shaft

SP_K Series

30 mm
polymeric casing.
1 cable inlet. IP 65



Contact blocks

	K10	K80	K71	K72	K61
Z11 (1NO+1NC)	SP•K10Z11	SP•K80Z11	SP•K71Z11	SP•K72Z11	SP•K61Z11
Z02 (2NC)	SP•K10Z02	SP•K80Z02	SP•K71Z02	SP•K72Z02	SP•K61Z02
X11 (1NO+1NC)	SP•K10X11	SP•K80X11	SP•K71X11	SP•K72X11	SP•K61X11
Y11 (1NO+1NC)	SP•K10Y11	SP•K80Y11	SP•K71Y11	SP•K72Y11	SP•K61Y11
W02 (2NC)	SP•K10W02	SP•K80W02	SP•K71W02	SP•K72W02	SP•K61W02
X21P (2NO+1NC)	SP•K10X21P	SP•K80X21P	SP•K71X21P	SP•K72X21P	SP•K61X21P
X12P (1NO+2NC)	SP•K10X12P	SP•K80X12P	SP•K71X12P	SP•K72X12P	SP•K61X12P
W03P (3NC)	SP•K10W03P	SP•K80W03P	SP•K71W03P	SP•K72W03P	SP•K61W03P

SM_K Series

30 mm metal casing.
1 cable inlet. IP 66



K10



K80

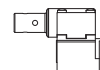

K71

K72



K61

Contact blocks

	K10	K80	K71	K72	K61
Z11 (1NO+1NC)	SM•K10Z11	SM•K80Z11	SM•K71Z11	SM•K72Z11	SM•K61Z11
Z02 (2NC)	SM•K10Z02	SM•K80Z02	SM•K71Z02	SM•K72Z02	SM•K61Z02
X11 (1NO+1NC)	SM•K10X11	SM•K80X11	SM•K71X11	SM•K72X11	SM•K61X11
Y11 (1NO+1NC)	SM•K10Y11	SM•K80Y11	SM•K71Y11	SM•K72Y11	SM•K61Y11
W02 (2NC)	SM•K10W02	SM•K80W02	SM•K71W02	SM•K72W02	SM•K61W02
X21P (2NO+1NC)	SM•K10X21P	SM•K80X21P	SM•K71X21P	SM•K72X21P	SM•K61X21P
X12P (1NO+2NC)	SM•K10X12P	SM•K80X12P	SM•K71X12P	SM•K72X12P	SM•K61X12P
W03P (3NC)	SM•K10W03P	SM•K80W03P	SM•K71W03P	SM•K72W03P	SM•K61W03P

SDP_K Series

50 mm polymeric casing.
2 cable inlets. IP 65



K10

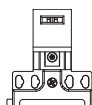

K80

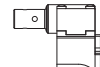

K71

K72

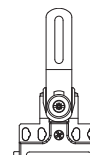

K61

Contact blocks

	K10	K80	K71	K72	K61
Z11 (1NO+1NC)	SDP•K10Z11	SDP•K80Z11	SDP•K71Z11	SDP•K72Z11	SDP•K61Z11
Z02 (2NC)	SDP•K10Z02	SDP•K80Z02	SDP•K71Z02	SDP•K72Z02	SDP•K61Z02
X11 (1NO+1NC)	SDP•K10X11	SDP•K80X11	SDP•K71X11	SDP•K72X11	SDP•K61X11
Y11 (1NO+1NC)	SDP•K10Y11	SDP•K80Y11	SDP•K71Y11	SDP•K72Y11	SDP•K61Y11
W02 (2NC)	SDP•K10W02	SDP•K80W02	SDP•K71W02	SDP•K72W02	SDP•K61W02
X21P (2NO+1NC)	SDP•K10X21P	SDP•K80X21P	SDP•K71X21P	SDP•K72X21P	SDP•K61X21P
X12P (1NO+2NC)	SDP•K10X12P	SDP•K80X12P	SDP•K71X12P	SDP•K72X12P	SDP•K61X12P
W03P (3NC)	SDP•K10W03P	SDP•K80W03P	SDP•K71W03P	SDP•K72W03P	SDP•K61W03P

SDM_K Series

50 mm metal casing.
3 cable inlets. IP 66

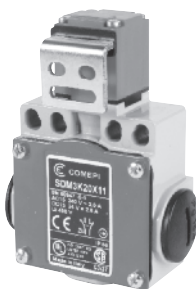

K10

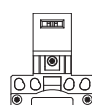

K80

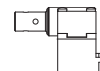

K71

K72

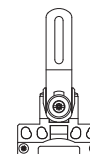

K61

Contact blocks

	K10	K80	K71	K72	K61
Z11 (1NO+1NC)	SDM•K10Z11	SDM•K80Z11	SDM•K71Z11	SDM•K72Z11	SDM•K61Z11
Z02 (2NC)	SDM•K10Z02	SDM•K80Z02	SDM•K71Z02	SDM•K72Z02	SDM•K61Z02
X11 (1NO+1NC)	SDM•K10X11	SDM•K80X11	SDM•K71X11	SDM•K72X11	SDM•K61X11
Y11 (1NO+1NC)	SDM•K10Y11	SDM•K80Y11	SDM•K71Y11	SDM•K72Y11	SDM•K61Y11
W02 (2NC)	SDM•K10W02	SDM•K80W02	SDM•K71W02	SDM•K72W02	SDM•K61W02
X21P (2NO+1NC)	SDM•K10X21P	SDM•K80X21P	SDM•K71X21P	SDM•K72X21P	SDM•K61X21P
X12P (1NO+2NC)	SDM•K10X12P	SDM•K80X12P	SDM•K71X12P	SDM•K72X12P	SDM•K61X12P
W03P (3NC)	SDM•K10W03P	SDM•K80W03P	SDM•K71W03P	SDM•K72W03P	SDM•K61W03P

SBM_K Series

40 mm aluminium casing.
1 cable inlet. IP 66



K4000

Key operated
90° adjustable head
(replaces K40)

Contact blocks

		K4000
Z11	(1NO+1NC)	SBM•K4000Z11
Z02	(2NC)	SBM•K4000Z02
X11	(1NO+1NC)	SBM•K4000X11
Y11	(1NO+1NC)	SBM•K4000Y11
W02	(2NC)	SBM•K4000W02
X21	(2NO+1NC)	SBM•K4000X21
X12	(1NO+2NC)	SBM•K4000X12
W03	(3NC)	SBM•K4000W03

SCM_K Series

60 mm aluminium casing.
3 cable inlets. IP 66

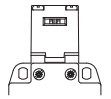

K4000

Key operated
90° adjustable head
(replaces K40)

Contact blocks

		K4000
Z11	(1NO+1NC)	SCM•K4000Z11
Z02	(2NC)	SCM•K4000Z02
X11	(1NO+1NC)	SCM•K4000X11
Y11	(1NO+1NC)	SCM•K4000Y11
W02	(2NC)	SCM•K4000W02
X21	(2NO+1NC)	SCM•K4000X21
X12	(1NO+2NC)	SCM•K4000X12
W03	(3NC)	SCM•K4000W03

SBP_K Series

40 mm polymeric casing.
1 cable inlet. IP 65

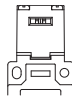

K3000

Key operated
90° adjustable head
(replaces K30)

Contact blocks

		K3000
Z11	(1NO+1NC)	SBP•K3000Z11
Z02	(2NC)	SBP•K3000Z02
X11	(1NO+1NC)	SBP•K3000X11
Y11	(1NO+1NC)	SBP•K3000Y11
W02	(2NC)	SBP•K3000W02
X21	(2NO+1NC)	SBP•K3000X21
X12	(1NO+2NC)	SBP•K3000X12
W03	(3NC)	SBP•K3000W03

Electrical connection

Replace the symbol with the number of the required thread

- 1: PG 13,5
- 2: 1/2" NPT (Through adapter on SP and SDP series)
- 3: PG 11 (Available on SP, SM, SDP and SDM series)
- 4: M16x1,5 (Available on SP, SM, SDP and SDM series)
- 5: M20x1,5

Operating keys (to be ordered separately)

Description	Bent key	Flat key	Bent key	Flat key	Shock absorbing bent key	Shock absorbing flat key	Adjustable joint key
Centre distance fixing holes (mm)	22	22	13	13	15	15	40
	Code	Code	Code	Code	Code	Code	Code
For operating heads K10 and K80	3	4	5	6	7	8	9
			Code	Code			Code
For operating heads K3000 and K4000			45	46			49



SM_K series

Metal casing. 30 mm width.
1 cable inlet - IP66

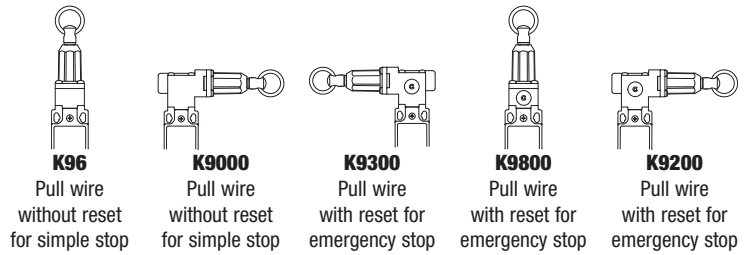

Contact elements		↻ K96	↻ K9000	↻ K9300	↻ K9800	↻ K9200
X11	(1NO+1NC)	SM•K96X11	SM•K9000X11	SM•K9300X11	SM•K9800X11	SM•K9200X11
W02	(2NC)	SM•K96W02	SM•K9000W02	SM•K9300W02	SM•K9800W02	SM•K9200W02
X12P	(1NO+2NC)	SM•K96X21P	SM•K9000X21P	SM•K9300X21P	SM•K9800X21P	SM•K9200X21P
X21P	(2NO+1NC)	SM•K96X12P	SM•K9000X12P	SM•K9300X12P	SM•K9800X12P	SM•K9200X12P
W03P	(3NC)	SM•K96W03P	SM•K9000W03P	SM•K9300W03P	SM•K9800W03P	SM•K9200W03P



SDM_K series

Metal casing. 50 mm width.
3 cable inlets - IP66

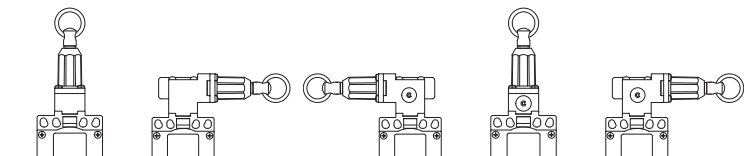

Contact elements		↻ K96	↻ K9000	↻ K9300	↻ K9800	↻ K9200
X11	(1NO+1NC)	SDM•K96X11	SDM•K9000X11	SDM•K9300X11	SDM•K9800X11	SDM•K9200X11
W02	(2NC)	SDM•K96W02	SDM•K9000W02	SDM•K9300W02	SDM•K9800W02	SDM•K9200W02
X12P	(1NO+2NC)	SDM•K96X21P	SDM•K9000X21P	SDM•K9300X21P	SDM•K9800X21P	SDM•K9200X21P
X21P	(2NO+1NC)	SDM•K96X12P	SDM•K9000X12P	SDM•K9300X12P	SDM•K9800X12P	SDM•K9200X12P
W03P	(3NC)	SDM•K96W03P	SDM•K9000W03P	SDM•K9300W03P	SDM•K9800W03P	SDM•K9200W03P



SBM_K series

Aluminium casing. 40 mm width.
1 cable inlet - IP66

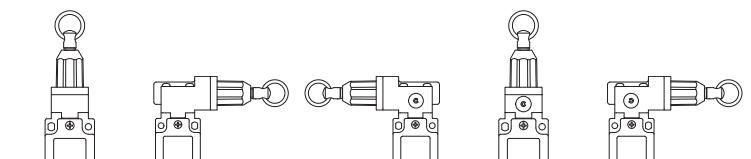

Contact elements		↻ K97	↻ K9100	↻ K9500	↻ K9900	↻ K9400
X11	(1NO+1NC)	SBM•K97X11	SBM•K9100X11	SBM•K9500X11	SBM•K9900X11	SBM•K9400X11
W02	(2NC)	SBM•K97W02	SBM•K9100W02	SBM•K9500W02	SBM•K9900W02	SBM•K9400W02
X12P	(1NO+2NC)	SBM•K97X21	SBM•K9100X21	SBM•K9500X21	SBM•K9900X21	SBM•K9400X21
X21P	(2NO+1NC)	SBM•K97X12	SBM•K9100X12	SBM•K9500X12	SBM•K9900X12	SBM•K9400X12
W03P	(3NC)	SBM•K97W03	SBM•K9100W03	SBM•K9500W03	SBM•K9900W03	SBM•K9400W03

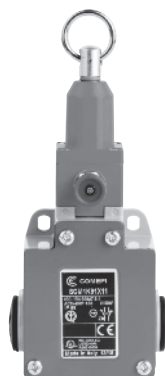

SCM_K series

Aluminium casing. 60 mm width.
3 cable inlets - IP66

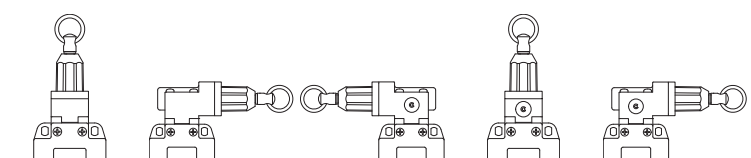

Contact elements		↻ K97	↻ K9100	↻ K9500	↻ K9900	↻ K9400
X11	(1NO+1NC)	SCM•K97X11	SCM•K9100X11	SCM•K9500X11	SCM•K9900X11	SCM•K9400X11
W02	(2NC)	SCM•K97W02	SCM•K9100W02	SCM•K9500W02	SCM•K9900W02	SCM•K9400W02
X12P	(1NO+2NC)	SCM•K97X21	SCM•K9100X21	SCM•K9500X21	SCM•K9900X21	SCM•K9400X21
X21P	(2NO+1NC)	SCM•K97X12	SCM•K9100X12	SCM•K9500X12	SCM•K9900X12	SCM•K9400X12
W03P	(3NC)	SCM•K97W03	SCM•K9100W03	SCM•K9500W03	SCM•K9900W03	SCM•K9400W03

Stay Bolt

Code
OCC 08

Rope Clamp

Code
MOR 05

Rope eye

Code
RED 05

Rope \varnothing 5mm

Code
FUN05M010
FUN05M015
FUN05M020
FUN05M025
FUN05M102

Code
SLS-FX1

Description
Hook stay bolt

Code
SLS-FX2

Description
Fixing clamp

Code
SLS-FX3

Description
Stay bolt

Code
SLS-M1

Description
Spring for SM, SDM series

Code
SLS-M2

Description
Spring for SBM, SCM series

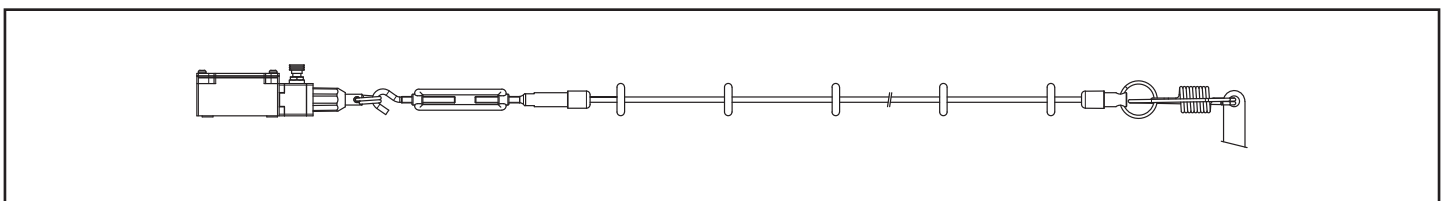
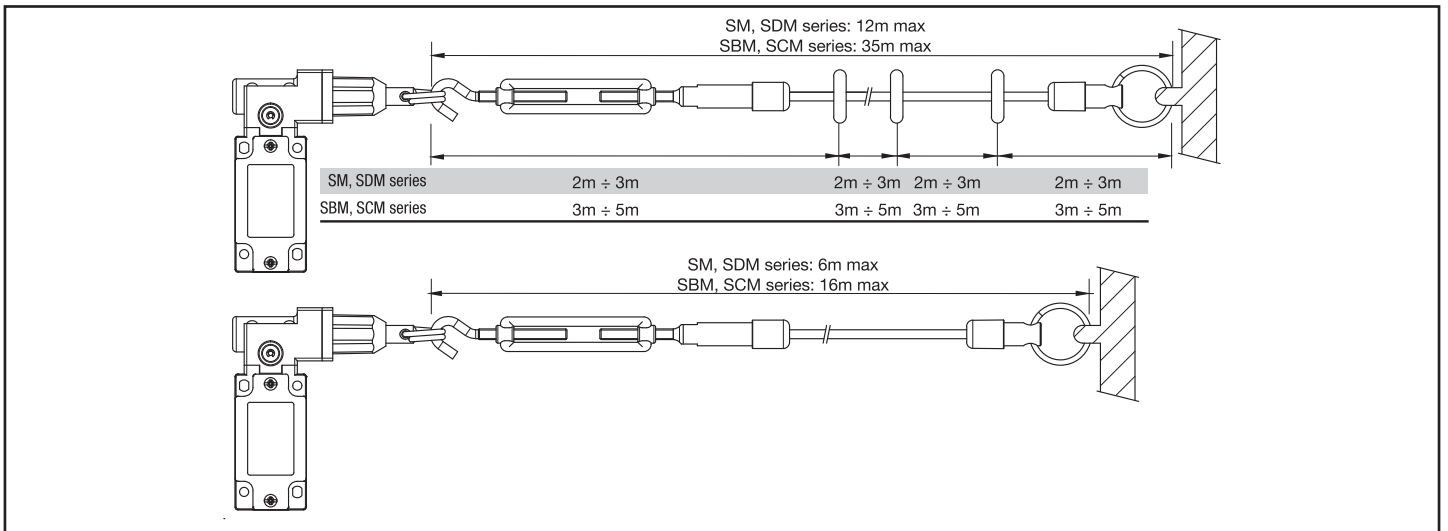
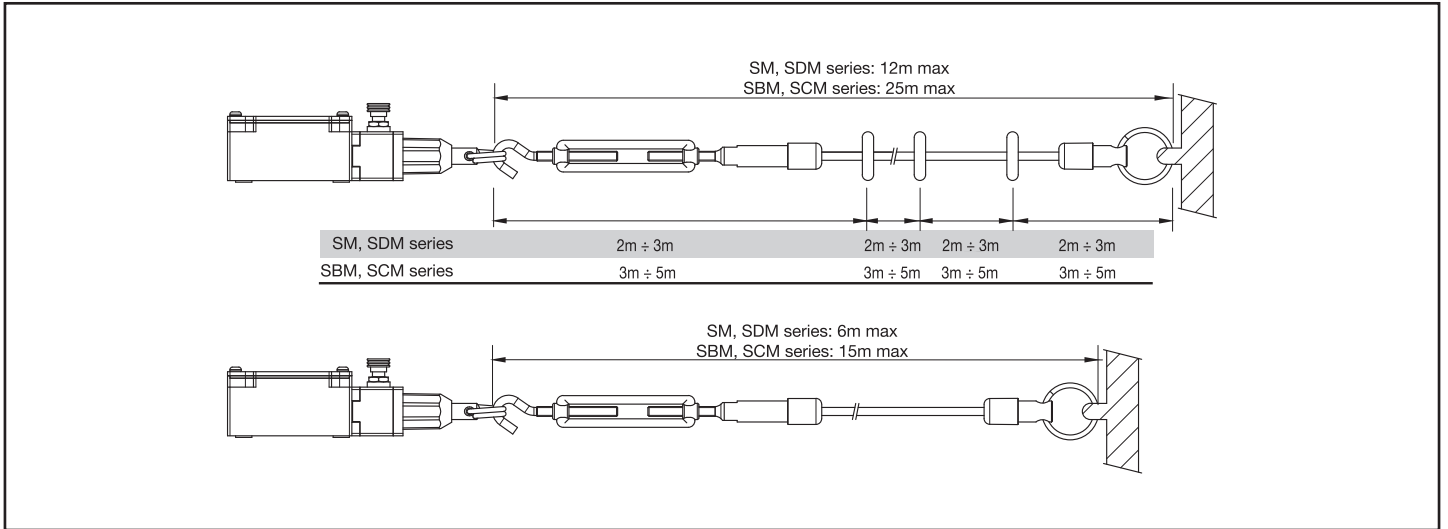
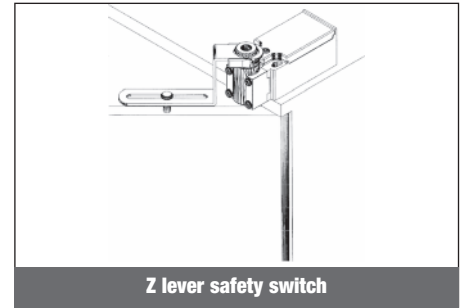
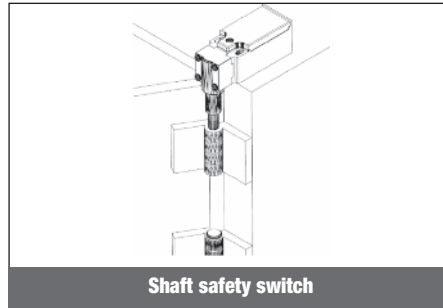
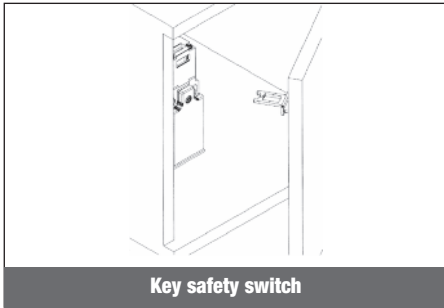

AP_R series 30 mm. polymeric limit switches - IP 65
EN 50047 - 1 cables entry



Cable inlets

AP1: PG 13.5

AP2: 1/2" NPT

(with adapter)

AP3: PG 11

AP4: M 16 x 1,5

AP5: M 20 x 1,5



Steel plunger with reset

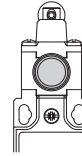

Steel plunger with nylon roller with reset



Steel plunger with nylon roller with reset

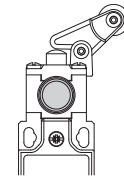

Steel plunger with nylon roller with reset

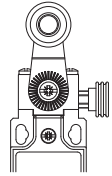

Lever with nylon roller with reset

Contact blocks

	R11	R13	R31	R32	R41
Z11 (1NA+1NC)	AP•R11Z11	AP•R13Z11	AP•R31Z11	AP•R32Z11	AP•R41Z11
Z02 (2NC)	AP•R11Z02	AP•R13Z02	AP•R31Z02	AP•R32Z02	AP•R41Z02
X11 (1NA+1NC)	AP•R11X11	AP•R13X11	AP•R31X11	AP•R32X11	AP•R41X11
W02 (2NC)	AP•R11W02	AP•R13W02	AP•R31W02	AP•R32W02	AP•R41W02
X21P (2NA+1NC)	AP•R11X21P	AP•R13X21P	AP•R31X21P	AP•R32X21P	AP•R41X21P
X12P (1NA+2NC)	AP•R11X12P	AP•R13X12P	AP•R31X12P	AP•R32X12P	AP•R41X12P
W03P (3NC)	AP•R11W03P	AP•R13W03P	AP•R31W03P	AP•R32W03P	AP•R41W03P

Other versions available on request

AM_R series 30 mm. metal limit switches - with polymeric working heads - IP 66
1 cables entry



Cable inlets

AM1: PG 13.5

AM2: 1/2" NPT

AM3: PG 11

AM4: M 16 x 1,5

AM5: M 20 x 1,5

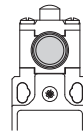

Steel plunger with reset



Steel plunger with nylon roller with reset



Steel plunger with nylon roller with reset

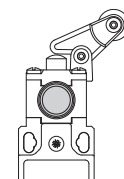

Steel plunger with nylon roller with reset

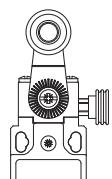

Lever with nylon roller with reset

Contact blocks

	R11	R13	R31	R32	R41
Z11 (1NA+1NC)	AM•R11Z11	AM•R13Z11	AM•R31Z11	AM•R32Z11	AM•R41Z11
Z02 (2NC)	AM•R11Z02	AM•R13Z02	AM•R31Z02	AM•R32Z02	AM•R41Z02
X11 (1NA+1NC)	AM•R11X11	AM•R13X11	AM•R31X11	AM•R32X11	AM•R41X11
W02 (2NC)	AM•R11W02	AM•R13W02	AM•R31W02	AM•R32W02	AM•R41W02
X21P (2NA+1NC)	AM•R11X21P	AM•R13X21P	AM•R31X21P	AM•R32X21P	AM•R41X21P
X12P (1NA+2NC)	AM•R11X12P	AM•R13X12P	AM•R31X12P	AM•R32X12P	AM•R41X12P
W03P (3NC)	AM•R11W03P	AM•R13W03P	AM•R31W03P	AM•R32W03P	AM•R41W03P

Other versions available on request

DP_R series 50 mm. polymeric limit switches - IP 65

2 cables entries

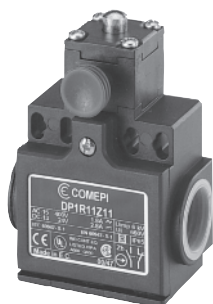

Cable inlets

DP1: PG 13.5

DP2: 1/2" NPT

(with adapter)

DP3: PG 11

DP4: M 16 x 1,5

DP5: M 20 x 1,5

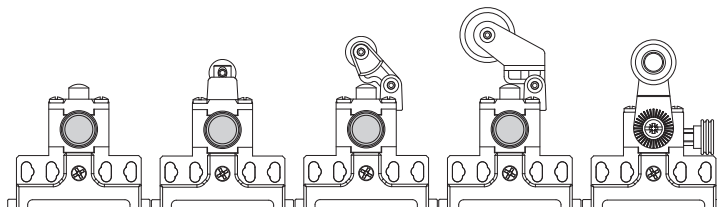

Steel plunger with reset

Steel plunger with nylon roller with reset

Steel plunger with nylon roller with reset

Steel plunger with nylon roller with reset

Lever with nylon roller with reset

Contact blocks

Z11 (1NA+1NC)

Z02 (2NC)

X11 (1NA+1NC)

W02 (2NC)

X21P (2NA+1NC)

X12P (1NA+2NC)

W03P (3NC)

R11

R13

R31

R38

R41

DP•R11Z11

DP•R13Z11

DP•R31Z11

DP•R38Z11

DP•R41Z11

DP•R11Z02

DP•R13Z02

DP•R31Z02

DP•R38Z02

DP•R41Z02

DP•R11X11

DP•R13X11

DP•R31X11

DP•R38X11

DP•R41X11

DP•R11W02

DP•R13W02

DP•R31W02

DP•R38W02

DP•R41W02

DP•R11X21P

DP•R13X21P

DP•R31X21P

DP•R38X21P

DP•R41X21P

DP•R11X12P

DP•R13X12P

DP•R31X12P

DP•R38X12P

DP•R41X12P

DP•R11W03P

DP•R13W03P

DP•R31W03P

DP•R38W03P

DP•R41W03P

Other versions available on request

DM_R series 50 mm. metal limit switches - with polymeric working heads - IP 66

3 cables entries



Cable inlets

DM1: PG 13.5

DM2: 1/2" NPT

DM3: PG 11

DM4: M 16 x 1,5

DM5: M 20 x 1,5

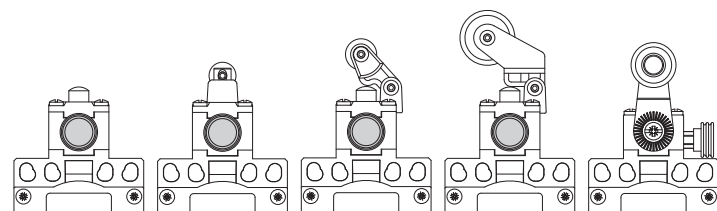

Steel plunger with reset

Steel plunger with nylon roller with reset

Steel plunger with nylon roller with reset

Steel plunger with nylon roller with reset

Lever with nylon roller with reset

Contact blocks

Z11 (1NA+1NC)

Z02 (2NC)

X11 (1NA+1NC)

W02 (2NC)

X21P (2NA+1NC)

X12P (1NA+2NC)

W03P (3NC)

R11

R13

R31

R38

R41

DM•R11Z11

DM•R13Z11

DM•R31Z11

DM•R38Z11

DM•R41Z11

DM•R11Z02

DM•R13Z02

DM•R31Z02

DM•R38Z02

DM•R41Z02

DM•R11X11

DM•R13X11

DM•R31X11

DM•R38X11

DM•R41X11

DM•R11W02

DM•R13W02

DM•R31W02

DM•R38W02

DM•R41W02

DM•R11X21P

DM•R13X21P

DM•R31X21P

DM•R38X21P

DM•R41X21P

DM•R11X12P

DM•R13X12P

DM•R31X12P

DM•R38X12P

DM•R41X12P

DM•R11W03P

DM•R13W03P

DM•R31W03P

DM•R38W03P

DM•R41W03P

Other versions available on request



NOTES

A large rectangular area filled with a light blue grid pattern, intended for taking notes. The grid lines are thin and evenly spaced.