

Xgard

Gas Detectors

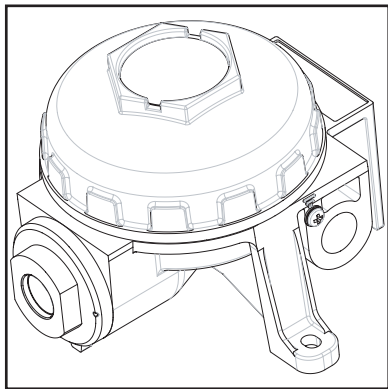

Installation, operating and maintenance instructions

M07249

Issue 11

January 2015

CROWCON

Detecting Gas Saving Lives

Safety information

- **Xgard** gas detectors must be installed, operated and maintained in strict accordance with these instructions, warnings, label information, and within the limitations stated.
- The lid on flameproof versions of **Xgard** must be kept tightly closed until power to the detector is isolated otherwise ignition of a flammable atmosphere can occur. Before removing the cover for maintenance or calibration purposes, ensure the surrounding atmosphere is free of flammable gases or vapours.
- **Xgard** detectors are designed to detect gases or vapours in air, and not inert or oxygen deficient atmospheres. **Xgard** oxygen detectors can measure in oxygen deficient atmospheres.
- Electrochemical cells used in toxic and oxygen versions of **Xgard** contain small volumes of corrosive electrolyte. Care should be observed when replacing cells to ensure that the electrolyte does not come into contact with skin or eyes.
- Maintenance and calibration operations must only be performed by qualified service personnel.
- Only genuine Crowcon replacement parts must be used, substitute components may invalidate the certification and warranty of the detector.
- **Xgard** detectors must be protected from extreme vibration, and direct sunlight in hot environments as this may cause the temperature of the detector to rise above its specified limits and cause premature failure. A sunshade is available for Xgard.
- This equipment must not be used in a Carbon Disulphide atmosphere.
- **Xgard** Types 2, 3, 5 & 6 are certified for use in atmospheres that may contain flammable dusts. They will not however detect the presence of flammable dust, and the response of the gas sensor may be compromised by becoming blocked in a dusty environment. **Xgard** detectors should be inspected regularly if used in a dusty environment.
- For Exd certified Xgard's (Types 2-6) cable glands with a sealing compound must be used where Group IIC gases are likely to be present (ref: EN60079-14:2008 section 10.4.2).

Hazardous area classifications:

- Zone 0: An area classified as Zone 0 will have ignitable concentrations of flammable gases, vapours or liquids either continuously present or present for long periods of time under normal operating conditions. Intrinsically Safe (Exia) detectors are suitable for use in Zone 0, provided they are connected via a suitable zener barrier or galvanic isolator.
- Zone 1: An area classified as Zone 1 is likely to have ignitable concentrations of flammable gases, vapours or liquids present under normal operating conditions. Flameproof (Exd) detectors are suitable for use in Zone 1. Intrinsically Safe (Exia) detectors are suitable for use in Zone 1, provided they are connected via a suitable zener barrier or galvanic isolator.
- Zone 2: An area classified as Zone 2 is not likely to have ignitable concentrations of flammable gases, vapours or liquids present under normal operating conditions. Flameproof (Exd) detectors are suitable for use in Zone 2. Intrinsically Safe (Exia) detectors are suitable for use in Zone 2, provided they are connected via a suitable zener barrier or galvanic isolator.

Areas that may contain flammable dusts are categorized as Zone, 20, Zone 21 and Zone 22.

Notes:

In North America 'Divisions' are used to categorise risk where:

Division 1 is equivalent to Zone 0 or 1

Division 2 is equivalent to Zone 2

Under European ATEX rules hazardous area equipment has been re-defined under 'equipment categories' where:

Equipment Category 1 is suitable for Zone 0

Equipment Category 2 is suitable for Zone 1

Equipment Category 3 is suitable for Zone 2

Overview

Product overview

Xgard are a family of gas detectors for monitoring a very wide range of toxic and flammable gases and oxygen. Xgard are available as either Intrinsically Safe (Exia) or Flameproof (Exd) detectors, dependant upon sensor type and customer preference. Intrinsically Safe versions are suitable for use in Zone 0, 1 or 2 hazardous areas when used with a suitable Zener barrier or galvanic isolator. Flameproof versions are suitable for use in Zone 1 or 2 hazardous areas.

Please refer to the certification label on the detector junction box to identify the type of certification that relates to the product supplied. Hazardous area definitions are shown in the Hazardous area classifications section on page 3.

Note: if no certification label is fitted to the junction box, the detector is not certified for use in hazardous areas.

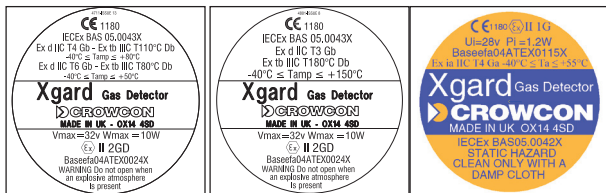

Xgard Types 2,3,5,6 ATEX and IECEX Flameproof label

Xgard Type 4 ATEX and IECEX Flameproof label

Intrinsically Safe Type 1

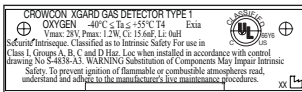

Xgard UL Flameproof

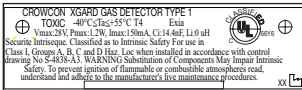

Xgard Intrinsically Safe - Type 1 UL

Diagram 1: Xgard certification labels

Each type of **Xgard** detector is identified by a label fitted on the junction box body. Please quote the 'model number', 'gas range' and 'sensor type' when contacting Crowcon for advice or spares.

This manual covers all versions of **Xgard**, care should be taken to ensure that the correct section is referenced according to the type of detector used. The **Xgard** detector type is detailed on the product label. The Xgard range is as shown:

Type 1: Intrinsically safe toxic and oxygen gas detector

Type 2: Flameproof toxic and oxygen gas detector

Type 3: Flameproof flammable gas detector

Type 4: Flameproof high temperature flammable gas detector

Type 5: Flameproof flammable gas detector with 4-20mA output

Type 6: Flameproof thermal conductivity type gas detector

Product description

Xgard comprises of a universal assembly to accommodate the full range of toxic, flammable and oxygen gas sensors. The assembly comprises five main parts; the junction box, junction box lid, amplifier/terminal PCB, sensor PCB and sensor retainer. These are shown in exploded form in Diagram 3.

A cover is fitted over the amplifier PCB to provide protection when the junction box is opened. This cover is designed to allow access to all cable terminals, test points and potentiometers without the need for removal.

The junction box is available in three versions: Glass-reinforced Nylon for Xgard Type 1; Corrosion-resistant aluminium for all Types; or 316 Stainless Steel for all Types. The junction box is supplied with 1 x M20, 1/2" or 3/4"NPT cable gland entry, on the right hand side for customer use. The junction box is suitable for fixing on the wall or ceiling using M6 fixings. Cable gland adaptors are available if required (see Spare parts and accessories section).

Overview

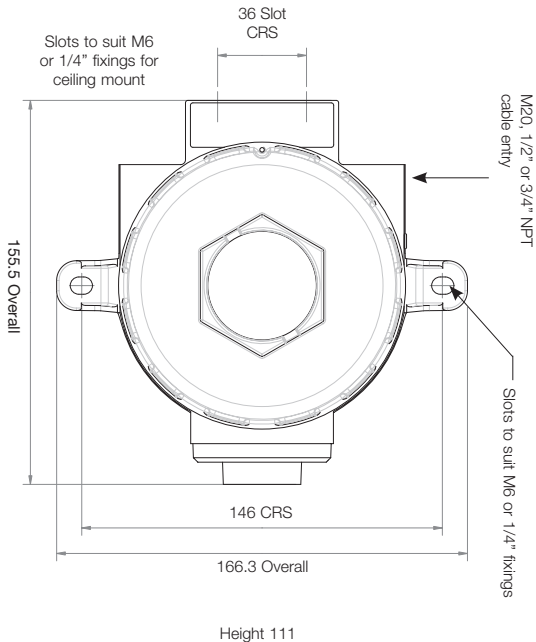

All dimensions in millimetres

Diagram 2: **Xgard** dimensioned view

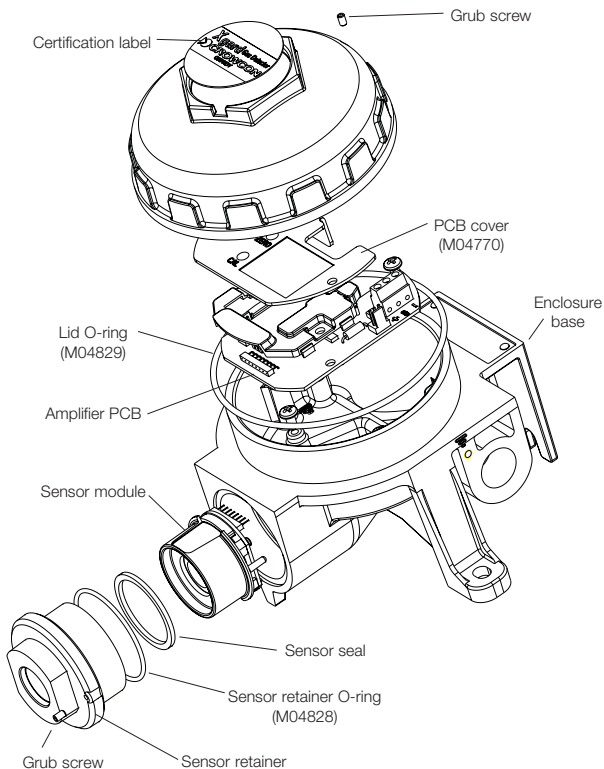

Diagram 3: **Xgard** exploded view (part numbers shown in brackets where applicable. For part numbers not shown, see Spares and Accessories on page 61)

Table of contents

Type 1 - Intrinsically safe toxic and oxygen gas detector.....	11
1. Introduction.....	11
2. Installation.....	12
3. Operation	15
4. Specification	18
Type 2 - Flameproof toxic and oxygen gas detector	19
1. Introduction.....	19
2. Installation.....	20
3. Operation	23
4. Specification	26
Type 3 - Flameproof flammable gas detector	27
1. Introduction.....	27
2. Installation.....	28
3. Operation	31
4. Specification	34
Type 4 - Flameproof high temperature flammable gas detector... 35	
1. Introduction.....	35
2. Installation.....	36
3. Operation	39
4. Specification	42
Type 5 - Flameproof flammable gas detector with 4-20mA output43	
1. Introduction.....	43
2. Installation.....	44
3. Operation	47
4. Specification	51
Type 6 - Flameproof thermal conductivity type gas detector..... 52	
1. Introduction.....	52
2. Installation.....	53
3. Operation	56
4. Specification	60
Spare parts and accessories.....	61
Appendix: Sensor limitations.....	63
Warranty.....	64

1.1 Intrinsically safe toxic and oxygen gas detector

This version of **Xgard** is an Intrinsically safe loop-powered (current-sink) 4-20 mA toxic or oxygen gas detector, designed to detect a wide range of gases when fitted with the appropriate electrochemical sensor. The detector is certified $\text{Ex II 1 G Ex ia IIC T4 Ga}$, and is suitable for use in Zone 0, Zone 1 and Zone 2 hazardous areas when used with a suitable Zener barrier or galvanic isolator.

Electrical connections to the detector are made via the terminal block on the amplifier PCB shown below. The amplifier provides power to the sensor, and converts the sensor signal into a 4-20 mA signal for connection to a control panel.

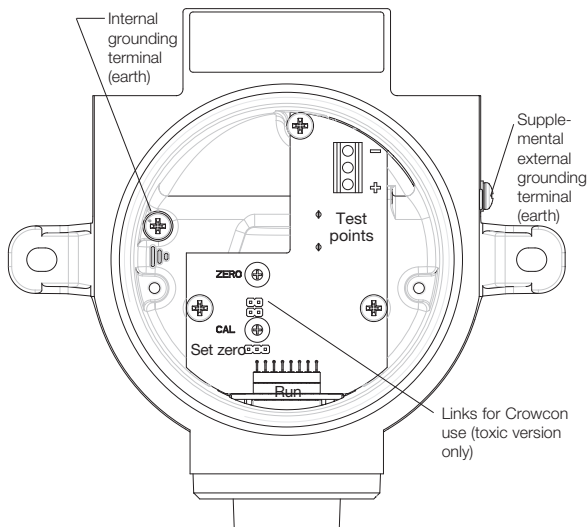



Diagram 4: **Xgard** Type 1 PCB layout
(Shown with PCB cover removed).

WARNING

This detector is designed for use in Zone 0, Zone 1 and Zone 2 hazardous areas, and is certified  II 1 G Ex ia IIC T4 Ga when used with a suitable Zener barrier or galvanic isolator.

Installation must be in accordance with the recognised standards of the appropriate authority in the country concerned.

For further information please contact Crowcon. Prior to carrying out any installation work ensure local regulations and site procedures are followed.

2.1 Location

The detector should be mounted where the gas to be detected is most likely to be present. The following points should be noted when locating gas detectors:

- To detect gases which are lighter than air, detectors should be mounted at high level and Crowcon recommend the use of a collector cone (**Part No. C01051**) and accessory adaptor (**Part No. M04666**).
- To detect heavier than air gases, detectors should be mounted at low level.
- When locating detectors consider the possible damage caused by natural events e.g. rain or flooding. For detectors mounted outdoors Crowcon recommend the use of a Spray Deflector (**Part No. C01052**) and accessory adaptor (**Part No. M04666**).
- Mounting of oxygen detectors requires knowledge of the gas displacing the oxygen. For example, carbon dioxide is heavier than air and collects in low lying areas. It will displace oxygen and so detectors should be placed at low level.
- Consider ease of access for functional testing and servicing.
- Consider how the escaping gas may behave due to natural or forced air currents. Mount detectors in ventilation ducts if appropriate.
- Consider the process conditions. For example, ammonia is normally lighter than air, but if released from a cooling system, the gas may fall rather than rise.

The placement of sensors should be determined following advice of experts having specialist knowledge of gas dispersion, the plant processing equipment as well as safety and engineering issues. **The agreement reached on the locations of sensors should be recorded.** Crowcon would be pleased to assist in the selection and siting of gas detectors.

2.2 Mounting

Xgard should be installed at the designated location with the sensor pointing down. This ensures that dust or water will not collect on the sensor and stop gas entering the cell. The mounting detail is shown in Diagram 2. Care should be taken when installing the detector to avoid damaging the painted surface of the junction box and sensor retainer.

2.3 Cabling requirement

Cabling to **Xgard** must be in accordance with the recognised standards of the appropriate authority in the country concerned and meet the electrical requirements of the detector.

Crowcon recommend the use of 2-core screened cable with a minimum cross-sectional area of 0.5 mm² (20awg). Suitable weatherproof cable glands must be used. Intrinsically Safe cables should be identified by some means, for example coloured blue. Alternative cabling techniques such as steel conduit may be acceptable provided appropriate standards are met.

Xgard requires a dc supply of 8-30 V and is loop powered (if mounted in a hazardous area, do not apply a voltage higher than the maximum rating of the Zener barrier, typically 28 V). Ensure there is a minimum of 8 V at the detector, taking into account the voltage drop due to cable resistance, the Zener barrier (if fitted) and the sense resistance of the control panel to which it is connected.

For example, a nominal dc supply at the control panel of 24 V has a guaranteed minimum supply of 19.5 V. The circuit may demand up to 20 mA. Given a sense resistor in the control panel of 232 Ohms the maximum voltage drop allowed due to cable resistance is 6.8 V. The maximum loop resistance allowed is 340 Ohms (approx.).

A 1.5 mm² cable will typically allow cable runs up to 14 km. Table 1 below shows the maximum cable distances given typical cable parameters.

C.S.A.		Resistance (Ohms per km)		Max. Distance (km)	Max. Distance with 330 Ω Zener barrier km
mm ²	Awg	Cable	Loop		
1.0	17	18.1	36.2	9.4	0.35
1.5	15	12.1	24.2	14	0.5
2.5	13	7.4	14.8	23	0.85

Table 1: Maximum cable distances for typical cables

The acceptable cross sectional area of cable used is 0.5 to 2.5 mm² (20 to 13awg). **The table is provided for guidance only, actual cable parameters for each application should be used to calculate maximum cable distances.**

2.4 Electrical connections

All connections are made via the screw terminal block mounted on the amplifier PCB in the junction box. The terminals are marked '+' and '-' and correct polarity should be observed when connecting the detector to control equipment. This version of **Xgard** is a 4-20 mA current sink device, and requires a dc supply of 8-30 V.

Note: The internal grounding terminal (see diagram 4) shall be used as the grounding means of the **Xgard** gas detector. The external grounding terminal (see diagram 4) is only a supplemental bonding connection, and is only to be used where local authorities permit or require such a connection. To limit radio interference, the junction box and cable armour should be grounded (earthed) at the control panel. Ensure the earth connection is provided in a safe area only, so as to avoid earth loops and maintain I. S. certification.

Pepperl & Fuchs and MTL Zener barriers

Xgard Type 1 PCB

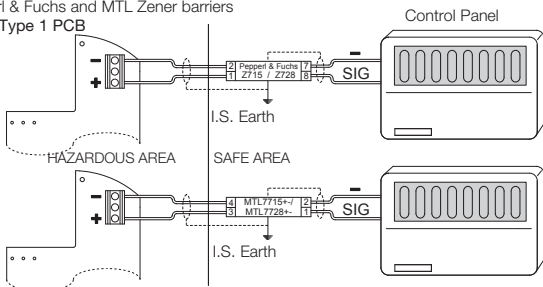

Pepperl & Fuchs and MTL galvanic isolators

Xgard Type 1 PCB

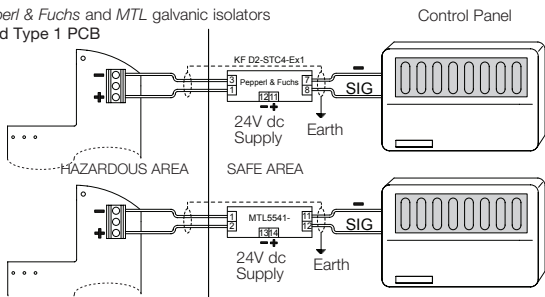

Diagram 5: **Xgard** Type 1 electrical connections

WARNING

Prior to carrying out any work ensure local regulations and site procedures are followed. Never attempt to open the detector or junction box when flammable gas is present. Ensure that the associated control panel is inhibited so as to prevent false alarms.

3.1a Commissioning procedure – toxic types only

1. Open the junction box of the detector by unscrewing the lid in an anti-clockwise direction (having loosened the retaining grub-screw first).
2. Check that all electrical connections have been made and are correct as per Diagram 5.
3. Apply power to the detector and ensure the minimum supply voltage of 8 V dc is present at the '+' and '-' terminals of the detector.
4. Leave the detector to stabilise for at least 1 hour, dependant upon sensor type.
5. Connect a digital volt meter (DVM) to the test points on the amplifier PCB.

NB Glass-reinforced Nylon junction boxes do not include a grub screw.

Note: At the test points, Zero will read 40 mV = 4 mA.

Full scale deflection will read 200 mV = 20 mA.

Zeroing the detector

6. Ensure you are in clean air. Adjust the 'ZERO' pot on the amplifier (which is accessible via a hole in the PCB cover) until the DVM reads 40 mV. Check that the control equipment display reads zero.

Calibrating the detector

7. Apply calibration gas (concentration should be at least 50% of sensor full-scale) to the detector at a flow rate of 0.5 - 1 litre/minute via a flow adaptor (**Part No. C03005**). Contact Crowcon for the supply of calibration gas.
8. Allow the gas reading to stabilise (usually 30 to 60 seconds) and adjust the 'CAL' pot until the DVM reads the appropriate reading. To calculate the reading use the formula and example below:

$$\left(\frac{160}{\text{Range}} \times \text{Gas} \right) + 40 = \text{mV setting}$$

Example: calibrating a 0-250 ppm carbon monoxide sensor using 150 ppm gas.

$$\left(\frac{160}{250} \times 150 \right) + 40 = 136 \text{ mV}$$

9. If the control equipment display requires adjustment consult the operating manual for the equipment.
10. Remove the gas and allow the sensor to completely settle before re-checking the zero setting.
11. Close the junction box of the detector ensuring that the lid is securely tightened, and the grub-screw is secured.
12. The detector is now operational.

3.1b Commissioning procedure – oxygen type only

Warning: A label is fitted over the sensor retainer aperture on oxygen detectors prior to shipment from Crowcon. The label isolates the oxygen sensor from air to minimize sensor life usage during storage and transit. It is essential that this label is removed prior to commissioning or before putting the detector into use.



1. Follow steps 1 to 5 given in 3.1a above.

Zeroing the detector

2. Remove the amplifier PCB covers and move the LINK on the amplifier board from 'RUN' to 'SET ZERO'. Adjust the 'ZERO' pot on the amplifier until the DVM reads 40 mV. Check that the control equipment display reads zero.

Calibrating the detector

3. With normal clean air present at the detector, replace the LINK to 'RUN' on the amplifier board, adjust the 'CAL' pot until the DVM reads 174 mV, (20.9% O₂). Leave the LINK in 'RUN' position and re-fit the PCB covers.
4. If the control equipment display requires adjustment consult the operating manual for the equipment.
5. Follow steps 11 and 12 given in 3.1a above. The detector is now operational.

3.2 Routine maintenance

The operational life of the sensors depends on the application, frequency and amount of gas being seen. Under normal conditions (6 monthly calibration with periodic exposure to CAL gas) the life expectancy of the toxic sensors is 2-3 years. Oxygen sensors must be replaced every two years.

Site practices will dictate the frequency with which detectors are tested. Crowcon would recommend that detectors be gas tested at least every 6 months and re-calibrated as necessary. To re-calibrate a detector follow the steps given in 3.1 above. The calibration frequency should be increased in environments subject to extreme heat and/or dust, and where gas is frequently present.

When performing maintenance on **Xgard**, ensure that the sensor retainer and junction box lid O-rings are present and in good condition to maintain the ingress protection of the product. See the 'Spare parts and accessories' section for the part numbers of replacement O-rings.

3.3 Sensor replacement/servicing of detectors

Xgard uses a modular design, which makes replacement of sensors extremely simple. Replacement sensors are supplied fitted to a sensor PCB to allow simple plug-in installation. An exploded view of **Xgard** is given in Diagram 3. The following procedure may be followed when servicing a **Xgard** detector.

WARNING

This work should be carried out by Crowcon or an approved service centre unless suitable training has been received.

1. Switch off and isolate power to the detector requiring attention.
2. Open the junction box of the detector by unscrewing the lid in an anti-clockwise direction (having loosened the retaining grub-screw first).
3. Unscrew the sensor retainer and remove the sensor and sensor PCB.
4. Fit the replacement sensor (having checked that the part number matches that stated on the detector junction box label), taking care to align the locating pins correctly with the slots in the junction box.
5. Re-fit the sensor retainer.
6. Follow the Commissioning Procedure given in 3.1.

Storage Instructions: The sensor used in this detector has a maximum non-powered storage life of 3 months. Sensors stored within a detector for longer than 3 months prior to commissioning may not last for the full expected operational life. The warranty period for the sensor begins from the date of shipment from Crowcon. Detectors should be stored in a cool and dry environment where temperatures remain within the 0-20°C range.

Cleaning: When cleaning Glass-reinforced Nylon junction boxes use a damp rather than dry cloth to avoid building up static electricity.

4. Specification

Xgard Type 1

Junction box material	ATEX: Glass-reinforced Nylon UL Version: Aluminium 316 Stainless Steel (optional)
Dimensions	156 x 166 x 111 mm (6.1 x 6.5 x 4.3 inches)
Weight	Aluminium: 1 kg (2.2 lbs) Glass-reinforced Nylon: 0.5 kg (1.1lb) Stainless Steel: 3.1 kg (6.8lbs) approx.
Operating voltage	8–30 V dc
Output	4-20 mA Sink (loop powered)
Fault signal	< 3 mA
Operating temperature	-20°C to +50°C (-4°F to +122°F) dependant upon sensor type
Humidity	0–90% RH, non condensing
Degree of protection	IP65
Explosion protection	Intrinsically Safe
Approval code	ATEX  II 1 G Ex ia IIC T4 Ga IECEX BAS 05.0042X Tamb = -40°C to 55°C UL& cUL Class I, Division 1, Groups A, B, C & D
Safety certificate no.	ATEX Baseefa04ATEX0115X
Standards	EN60079-0:2012, EN60079-11:2012 IEC 60079-0:2011 (Ed 6), IEC60079-11: 2011 (Ed 6), UL913
Zones	Certified for use in Zone 0, Zone 1 or Zone 2 (see hazardous area classifications section)
Gas groups	IIA, IIB, IIC (UL groups A, B, C, D)
EMC	EN50270

1.1 Flameproof toxic and oxygen gas detector

This version of **Xgard** is a Flameproof loop-powered (current-sink) 4-20 mA toxic or oxygen gas detector, designed to detect a wide range of gases when fitted with the appropriate electrochemical sensor. The detector is certified $\text{Ex II 2 GD Ex d IIC T6 Gb}$, and is suitable for use in Zone 1 and Zone 2 hazardous areas.

Electrical connections to the detector are made via the terminal block on the amplifier PCB shown below. The amplifier provides power to the sensor, and converts the sensor signal into a 4-20 mA signal for connection to a control panel.

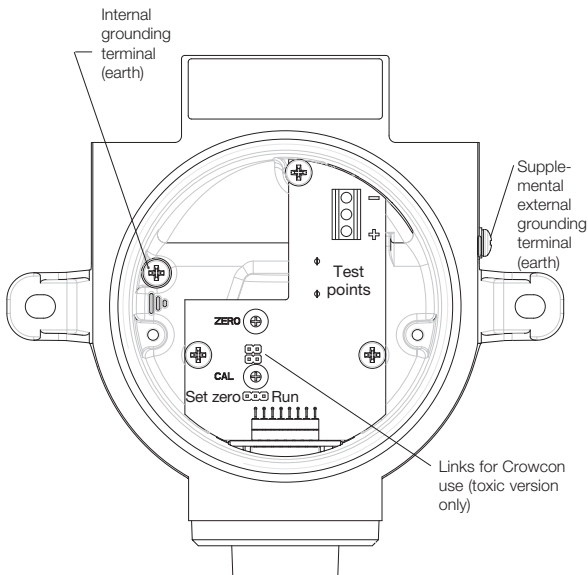

Diagram 6: **Xgard** Type 2 PCB layout
(Shown with PCB cover removed).

WARNING

This detector is designed for use in Zone 1 and Zone 2 hazardous areas, and is certified to 2 GD Ex d IIC T6 Gb. Installation must be in accordance with the recognised standards of the appropriate authority in the country concerned.

For further information please contact Crowcon. Prior to carrying out any installation work ensure local regulations and site procedures are followed.

2.1 Location

The detector should be mounted where the gas to be detected is most likely to be present. The following points should be noted when locating gas detectors:

- To detect gases which are lighter than air, detectors should be mounted at high level and Crowcon recommend the use of a collector cone (**Part No. C01051**) and accessory adaptor (**Part No. M04666**).
- To detect heavier than air gases, detectors should be mounted at low level.
- When locating detectors consider the possible damage caused by natural events e.g. rain or flooding. For detectors mounted outdoors Crowcon recommend the use of a Spray Deflector (**Part No. C01052**) and accessory adaptor (**Part No. M04666**).
- Mounting of oxygen detectors requires knowledge of the gas displacing the oxygen. For example, carbon dioxide is heavier than air and collects in low lying areas. It will displace oxygen and so detectors should be placed at low level.
- Consider ease of access for functional testing and servicing.
- Consider how the escaping gas may behave due to natural or forced air currents. Mount detectors in ventilation ducts if appropriate.
- Consider the process conditions. For example, ammonia is normally lighter than air, but if released from a cooling system, the gas may fall rather than rise.

The placement of sensors should be determined following advice of experts having specialist knowledge of gas dispersion, the plant processing equipment as well as safety and engineering issues. **The agreement reached on the locations of sensors should be recorded.** Crowcon would be pleased to assist in the selection and siting of gas detectors.

2.2 Mounting

Xgard should be installed at the designated location with the sensor pointing down. This ensures that dust or water will not collect on the sensor and stop gas entering the cell. The mounting detail is shown in Diagram 2. Care should be taken when installing the detector to avoid damaging the painted surface of the junction box and sensor retainer.

2.3 Cabling requirement

Cabling to **Xgard** must be in accordance with the recognised standards of the appropriate authority in the country concerned and meet the electrical requirements of the detector.

Crowcon recommend the use of steel wire armoured (SWA) cable and suitable explosion proof glands must be used. Alternative cabling techniques, such as steel conduit, may be acceptable provided appropriate standards are met.

Xgard requires a dc supply of 8-30 V and is loop powered. Ensure there is a minimum of 8 V at the detector, taking into account the voltage drop due to cable resistance and the sense resistance of the control panel to which it is connected.

For example, a nominal dc supply at the control panel of 24 V has a guaranteed minimum supply of 19.5 V. The circuit may demand up to 20 mA. Given a sense resistor in the control panel of 232 Ohms the maximum voltage drop allowed due to cable resistance is 6.8 V. The maximum loop resistance allowed is 340 Ohms (approx.).

A 1.5 mm² cable will typically allow cable runs up to 14 km. Table 2 below shows the maximum cable distances given typical cable parameters.

mm ²	C.S.A.	Resistance (Ohms per km)		Max. Distance (km)
	Awg	Cable	Loop	
1.0	17	18.1	36.2	9.4
1.5	15	12.1	24.2	14
2.5	13	7.4	14.8	23

Table 2: Maximum cable distances for typical cables

The acceptable cross sectional area of cable used is 0.5 to 2.5 mm² (20 to 13awg). **The table is provided for guidance only, actual cable parameters for each application should be used to calculate maximum cable distances.**

2.4 Electrical connections

All connections are made via the screw terminal block mounted on the amplifier PCB in the junction box. The terminals are marked '+' and '-' and correct polarity should be observed when connecting the detector to control equipment. This version of **Xgard** is a 4-20 mA current sink device, and requires a dc supply of 8-30 V.

Note: The internal grounding terminal (see diagram 6) shall be used as the grounding means of the **Xgard** gas detector. The external grounding terminal (see diagram 6) is only a supplemental bonding connection, and is only to be used where local authorities permit or require such a connection. To limit radio frequency interference, the junction box and cable armour should be grounded (earthed) at the control panel. Ensure the earth connection is in a safe area only, so as to avoid earth loops.

Xgard Type 2 PCB

Control Panel

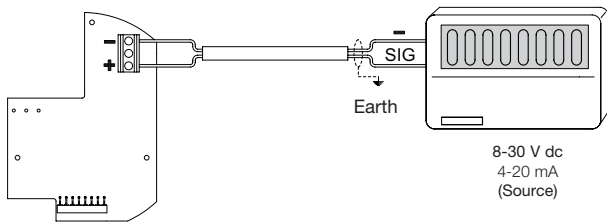

Diagram 7: **Xgard** Type 2 electrical connections

WARNING

Prior to carrying out any work ensure local regulations and site procedures are followed. Never attempt to open the detector or junction box when flammable gas is present. Ensure that the associated control panel is inhibited so as to prevent false alarms.

3.1a Commissioning procedure – toxic types only

1. Open the junction box of the detector by unscrewing the lid in an anti-clockwise direction (having loosened the retaining grub-screw first).
2. Check that all electrical connections have been made and are correct as per Diagram 7.
3. Apply power to the detector and ensure the minimum supply voltage of 8 V dc is present at the '+' and '-' terminals of the detector.
4. Leave the detector to stabilise for at least 1 hour, dependant upon sensor type.
5. Connect a digital volt meter (DVM) to the test points on the amplifier PCB.

Note: At the test points, Zero will read 40 mV = 4 mA.

Full scale deflection will read 200 mV = 20 mA.

Zeroing the detector

6. Ensure you are in clean air. Adjust the 'ZERO' pot on the amplifier (which is accessible via a hole in the PCB cover) until the DVM reads 40 mV. Check that the control equipment display reads zero.

Calibrating the detector

7. Apply calibration gas (concentration should be at least 50% of sensor full-scale) to the detector at a flow rate of 0.5 - 1 litre/minute via a flow adaptor (**Part No. C03005**). Contact Crowcon for the supply of calibration gas.
8. Allow the gas reading to stabilise (usually 30 to 60 seconds) and adjust the 'CAL' pot until the DVM reads the appropriate reading. To calculate the reading use the formula and example below:

$$\left(\frac{160}{\text{Range}} \times \text{Gas} \right) + 40 = \text{mV setting}$$

Example: calibrating a 0-250 ppm carbon monoxide sensor using 150 ppm gas.

$$\left(\frac{160}{250} \times 150 \right) + 40 = 136 \text{ mV}$$

9. If the control equipment display requires adjustment consult the operating manual for the equipment.
10. Remove the gas and allow the sensor to completely settle before re-checking the zero setting.
11. Close the junction box of the detector ensuring that the lid is securely tightened, and the grub-screw is secured.
12. The detector is now operational.

3.1b Commissioning procedure – oxygen type only

Warning: A label is fitted over the sensor retainer aperture on oxygen detectors prior to shipment from Crowcon. The label isolates the oxygen sensor from air to minimize sensor life usage during storage and transit. It is essential that this label is removed prior to commissioning or before putting the detector into use.



1. Follow steps 1 to 5 given in 3.1a above.

Zeroing the detector

2. Remove the amplifier PCB cover and move the LINK on the amplifier board from 'RUN' to 'SET ZERO'. Adjust the 'ZERO' pot on the amplifier until the DVM reads 40 mV. Check that the control equipment display reads zero.

Calibrating the detector

3. With normal clean air present at the detector, replace the LINK to 'RUN' on the amplifier board, adjust the 'CAL' pot until the DVM reads 174 mV, (20.9% O₂). Leave the LINK in 'RUN' position and re-fit the PCB cover.
4. If the control equipment display requires adjustment consult the operating manual for the equipment.
5. Follow steps 11 and 12 given in 3.1a above. The detector is now operational.

3.2 Routine maintenance

The operational life of the sensors depends on the application, frequency and amount of gas being seen. Under normal conditions (6 monthly calibration with periodic exposure to CAL gas) the life expectancy of the toxic sensors is 2-3 years. Oxygen sensors must be replaced every two years.

Site practices will dictate the frequency with which detectors are tested. Crowcon would recommend that detectors be gas tested at least every

6 months and re-calibrated as necessary. To re-calibrate a detector follow the steps given in 3.1 above. The calibration frequency should be increased in environments subject to extreme heat and/or dust, and where gas is frequently present.

The sinter should be inspected regularly, and replaced if it has become contaminated. A blocked sinter may prevent gas from reaching the sensor. When performing maintenance on **Xgard**, ensure that the sensor retainer and junction box lid O-rings are present and in good condition to maintain the ingress protection of the product. See the 'Spare parts and accessories' section for the part numbers of replacement O-rings.

3.3 Sensor replacement/servicing of detectors

Xgard uses a modular design, which makes replacement of sensors, or sinters extremely simple. Replacement sensors are supplied fitted to a sensor PCB to allow simple plug-in installation. An exploded view of **Xgard** is given in Diagram 3. The following procedure may be followed when servicing a **Xgard** detector.

WARNING

This work should be carried out by Crowcon or an approved service centre unless suitable training has been received.

1. Switch off and isolate power to the detector requiring attention.
2. Open the junction box of the detector by unscrewing the lid in an anti-clockwise direction (having loosened the retaining grub-screw first).
3. Unscrew the sensor retainer and remove the sensor and sensor PCB.
4. Fit the replacement sensor (having checked that the part number matches that stated on the detector junction box label), taking care to align the locating pins correctly with the slots in the junction box.
5. Re-fit the sensor retainer having first inspected the sinter to make sure that it has not become contaminated. Contaminated items should be replaced (see Spare Parts section for replacement part numbers), as any blockages may result in slow sensor response to gas, and reduced sensitivity.
6. Follow the Commissioning Procedure given in 3.1.

Storage Instructions: The sensor used in this detector has a maximum non-powered storage life of 3 months. Sensors stored within a detector for longer than 3 months prior to commissioning may not last for the full expected operational life. The warranty period for the sensor begins from the date of shipment from Crowcon. Detectors should be stored in a cool and dry environment where temperatures remain within the 0-20°C range.

Junction box material	Corrosion resistant alloy with polyester powder coating 316 Stainless Steel (optional)
Dimensions	156 x 166 x 111 mm (6.1 x 6.5 x 4.3 inches)
Weight	Alloy: 1 kg (2.2 lbs) Stainless Steel: 3.1 kg (6.8lbs) approx.
Operating voltage	8–30 V dc
Output	4-20 mA Sink (loop powered)
Fault signal	< 3 mA
Operating temperature	-20°C to +50°C (-4°F to +122°F) dependant upon sensor type
Humidity	0–90% RH, non condensing
Degree of protection	IP65
Explosion protection	Flameproof
Approval code	ATEX  II 2 GD Ex d IIC T6 Gb Extb IIIC T80°C Db IECEX BAS 05.0042 Tamb = -40°C to 50°C UL Class I, Division 1, Groups B, C & D
Safety certificate no.	ATEX Baseefa04ATEX0024X
Standards	EN60079-0:2012, EN60079-1:2007, EN60079-31:2009 IEC 60079-0:2011 (Ed 6), IEC60079-1: 2007 (Ed 6), IEC60079-31:2008 (Ed 1) UL1203
Zones	Certified for use in Zones 1 & 2 (Gas), and Zones 21 & 22 (Dust)
Gas groups	IIA, IIB, IIC (UL groups B, C, D)
EMC	EN50270

1.1 Flameproof flammable gas detector

This version of **Xgard** is a Flameproof gas detector, designed to detect flammable gas present in ambient air, at concentrations not exceeding the Lower Explosive Limit (LEL) of the target gas for which it is calibrated. **Xgard** Type 3 operates using pellistors as part of a 3-wire Wheatstone Bridge (WB) circuit, and must be connected to a suitable control card. The detector is certified Ⓜ II 2 GD Ex d IIC T6 Gb for operation up to 50°C (120°F), Ⓜ II 2 GD Ex d IIC T4 Gb for operation up to 80°C (176°F), and is suitable for use in Zone 1 and Zone 2 hazardous areas.

Electrical connections to the detector are made via the terminal block on the PCB shown below.

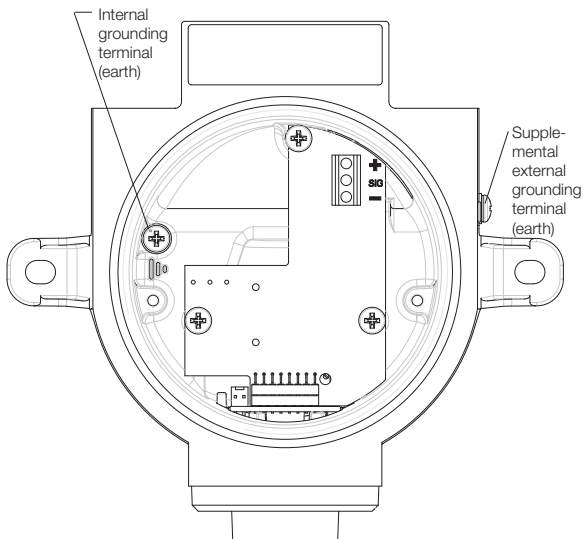

Diagram 8: **Xgard** Type 3 PCB layout
(Shown with PCB cover removed).

WARNING

This detector is designed for use in Zone 1 and Zone 2 hazardous areas, and is certified Ⓜ II 2 GD Ex d IIC T6 Gb for operation up to 50°C (122°F), Ⓜ II 2 GD Ex d IIC T4 Gb for operation up to 80°C (176°F). Installation must be in accordance with the recognised standards of the appropriate authority in the country concerned.

For further information please contact Crowcon. Prior to carrying out any installation work ensure local regulations and site procedures are followed.

2.1 Location

The detector should be mounted where the gas to be detected is most likely to be present. The following points should be noted when locating gas detectors:

- To detect gases which are lighter than air, detectors should be mounted at high level and Crowcon recommend the use of a collector cone (**Part No. C01051**) and accessory adaptor (**Part No. M04666**).
- To detect heavier than air gases, detectors should be mounted at low level.
- When locating detectors consider the possible damage caused by natural events e.g. rain or flooding. For detectors mounted outdoors Crowcon recommend the use of a Spray Deflector (**Part No. C01052**) and accessory adaptor (**Part No. M04666**).
- Consider ease of access for functional testing and servicing.
- Consider how the escaping gas may behave due to natural or forced air currents. Mount detectors in ventilation ducts if appropriate.
- Consider the process conditions. For example, butane is normally heavier than air, but if released from a process which is at an elevated temperature and/or pressure, the gas may rise rather than fall.

The placement of sensors should be determined following advice of experts having specialist knowledge of gas dispersion, the plant processing equipment as well as safety and engineering issues. **The agreement reached on the locations of sensors should be recorded.** Crowcon would be pleased to assist in the selection and siting of gas detectors.

2.2 Mounting

Xgard should be installed at the designated location with the sensor pointing down. This ensures that dust or water will not collect on the sensor and stop gas entering the cell. The mounting detail is shown in Diagram 2. Care should be taken when installing the detector to avoid damaging the painted surface of the junction box and sensor retainer.

2.3 Cabling requirement

Cabling to **Xgard** must be in accordance with the recognised standards of the appropriate authority in the country concerned and meet the electrical requirements of the detector.

Crowcon recommend the use of steel wire armoured (SWA) cable and suitable explosion proof glands must be used. Alternative cabling techniques, such as steel conduit, may be acceptable provided appropriate standards are met.

Maximum permissible cable lengths depend on the cable resistance and sensor being used. It is important that the correct bridge voltage be applied to the detector. This will vary depending on the part number of the sensor fitted (see 'Sensor type' on the label fitted to the junction box). Table 3 below summarises the bridge voltage requirements for different sensor types.

Sensor Part No.	Pellistor Type	Bridge Volts (Vdc)	Comment
Contact Crowcon VQ21T		2.0	Standard for CH ₄
Contact Crowcon 300P		2.0	Alternative for CH ₄
Contact Crowcon VQ8		2.5	Lead resistant for leaded petrol
Contact Crowcon VQ25		2.0	For halogens
Contact Crowcon VQ41		2.0	For Jet fuel
Contact Crowcon VQ41		2.0	For Ammonia

Table 3: Sensor options, please contact Crowcon for advice on alternative gases or vapours.

The following cable lengths are calculated assuming a 300mA constant current drive, with a minimum supply of 18 V dc from the control equipment:

C.S.A.		Resistance (Ohms per km)		Max. Distance (km)	Max. Distance (km)
mm ²	Awg	Cable	Loop	2.0 volt pellistors	2.5 volt pellistors
1.0	17	18.1	36.2	1.47	1.42
1.5	15	12.1	24.2	2.2	2.13
2.5	13	7.4	14.8	3.6	3.5

Table 4: maximum cable distances for typical cables

The acceptable cross sectional area of cable used is 0.5 to 2.5mm² (20 to 13awg). **The table is provided for guidance only, actual cable parameters for each application should be used to calculate maximum cable distances.**

2.4 Electrical connections

All connections are made via the screw terminal block mounted on the PCB in the junction box. The terminals are marked '+', 'sig' and '-' and correct polarity should be observed when connecting the detector to control equipment. This version of **Xgard** operates as part of a 3-wire mV Wheatstone bridge circuit and must be connected to a suitable control card.

Note: The internal grounding terminal (see diagram 8) shall be used as the grounding means of the **Xgard** gas detector. The external grounding terminal (see diagram 8) is only a supplemental bonding connection, and is only to be used where local authorities permit or require such a connection. To limit radio frequency interference, the junction box and cable armour should be grounded (earthed) at the control panel. Ensure the earth connection is provided in a safe area only, so as to avoid earth loops.

Xgard Type 3 PCB

Control Panel

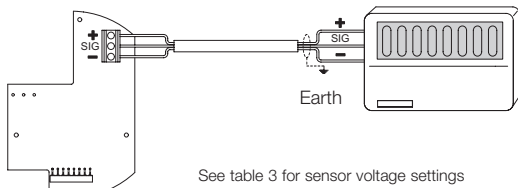

Diagram 9: **Xgard** Type 3 electrical connections

WARNING

Prior to carrying out any work ensure local regulations and site procedures are followed. Never attempt to open the detector or junction box when flammable gas is present. Ensure that the associated control panel is inhibited so as to prevent false alarms.

3.1 Commissioning procedure

1. Open the junction box of the detector by unscrewing the lid in an anti-clockwise direction (having loosened the retaining grub-screw first).
2. Check that all electrical connections have been made and are correct as per Diagram 9.
3. Measure the voltage across the '+' and '-' terminals and adjust according to the type of pellistor fitted (see Table 3).
4. Leave the detector to stabilise for at least 1 hour.
5. Balance the WB circuit at the control panel if necessary. Refer to the control equipment instruction manual.

Zeroing the detector

6. Ensure you are in clean air. Adjust the control equipment to read zero.

Calibrating the detector

7. Apply calibration gas (concentration should be 50% LEL) to the detector at a flow rate of 0.5 - 1 litre/minute via a flow adaptor (**Part No. C03005**). Contact Crowcon for the supply of calibration gas.
8. Allow the gas reading to stabilise (usually 30 to 60 seconds) and adjust the control equipment to read 50% LEL.
9. Remove the gas and allow the sensor to completely settle before re-checking the zero setting.
10. Close the junction box of the detector ensuring that the lid is securely tightened, and the grub-screw is secured.
11. The detector is now operational.

Note: ATEX certified Xgard flammable gas detectors will be supplied calibrated for compliance with EN60079-20-1 (where for example 100% LEL methane = 4.4% volume). UL certified detectors will be supplied calibrated for compliance with North American standards (where 100% LEL methane = 5% volume).

For further advice on balancing the amplifier and sensor module, especially where signal drift appears to have occurred, please contact Crowcon.

3.2 Routine maintenance

Pellistors can suffer from loss of sensitivity when there is a presence of poisons or inhibitors such as silicones, sulphides, chlorine, lead or halogenated hydrocarbons. Crowcon use poison resistant pellistors to maximise the operational life of **Xgard**. In applications where such compounds are continuously present we recommend the use of Crowcon's fixed point infrared flammable gas detectors, which are immune to such poisons and inhibitors. Please contact Crowcon for further details.

The operational life of the pellistors depends on the application and amount of gas to which the pellistor has been exposed. Under normal conditions (6 monthly calibration with periodic exposure to CAL gas) the life expectancy is 3-5 years.

Site practices will dictate the frequency with which detectors are tested. Crowcon would recommend that detectors be gas tested at least every 6 months and re-calibrated as necessary. To re-calibrate a detector follow the steps given in 3.1.

The sinter should be inspected regularly, and replaced if it has become contaminated. A blocked sinter may prevent gas from reaching the sensor.

When performing maintenance on **Xgard**, ensure that the sensor retainer and junction box lid O-rings are present and in good condition to maintain the ingress protection of the product. See the 'Spare parts and accessories' section for the part numbers of replacement O-rings.

3.3 Sensor replacement/servicing of detectors



Xgard uses a modular design, which makes replacement of sensors, or sinters extremely simple. Replacement sensors are supplied fitted to a sensor PCB to allow simple plug-in installation. An exploded view of **Xgard** is given in Diagram 3. The following procedure may be followed when servicing a **Xgard** detector.

WARNING

This work should be carried out by Crowcon or an approved service centre unless suitable training has been received.

1. Switch off and isolate power to the detector requiring attention.
2. Open the junction box of the detector by unscrewing the lid in an anti-clockwise direction (having loosened the retaining grub-screw first).
3. Unscrew the sensor retainer and remove the sensor and sensor PCB.
4. Fit the replacement sensor (having checked that the part number matches that stated on the detector junction box label), taking care to align the locating pins correctly with the slots in the junction box.
5. Re-fit the sensor retainer having first inspected the sinter to make sure that it has not become contaminated. Contaminated items should be replaced (see Spare Parts section for replacement part numbers), as any blockages may result in slow sensor response to gas, and reduced sensitivity.
6. Follow the Commissioning Procedure given in 3.1.

Storage Instructions: The sensor used in this detectors should be stored in a dry environment, and protected from exposure to silicones, sulphides, chlorines and lead. Exposure to these compounds will significantly reduce the sensitivity of the sensor, and render the sensor warranty void.

Junction box material	Corrosion resistant alloy with polyester powder coating 316 Stainless Steel (optional)
Dimensions	156 x 166 x 111 mm (6.1 x 6.5 x 4.3 inches)
Weight	Alloy: 1 kg (2.2 lbs) Stainless Steel: 3.1 kg (6.8lbs) approx.
Electrical output	3-wire mV bridge. Typically 12-15 mV per % CH ₄
Operating temperature	-40°C to +80°C (-40°F to +176°F)
Humidity	0–99% RH, non condensing
Degree of protection	IP65
Explosion protection	Flameproof
Approval code	ATEX  II 2 GD Ex d IIC T6 Gb Tamb = -40°C to 50°C Extb IIIC T80°C Db ATEX  II 2 GD Ex d IIC T4 Gb Tamb = -40°C to +80°C Extb IIIC T110°C Db IECEX BAS 05.0042 UL Class I, Division 1, Groups B, C & D IECEX BAS 05.0043X
Safety certificate no.	ATEX Baseefa04ATEX0024X
Standards	EN60079-0:2012, EN60079-1:2007, EN60079-31:2009 IEC 60079-0:2011 (Ed 6), IEC60079-1: 2007 (Ed 6), IEC60079-31:2008 (Ed 1) UL1203
Zones	Certified for use in Zones 1 & 2 (Gas), and Zones 21 & 22 (Dust)
Gas groups	IIA, IIB, IIC (UL groups B, C, D)
EMC	EN50270

1.1 Flameproof high temperature flammable gas detector

This version of **Xgard** is a Flameproof high temperature (150°C / 302°F) gas detector, designed to detect flammable gas present in ambient air, at concentrations not exceeding the Lower Explosive Limit (LEL) of the target gas for which it is calibrated. **Xgard** Type 4 operates using pellistors as part of a 3-wire Wheatstone Bridge (WB) circuit, and must be connected to a suitable control card. The detector is certified Ex d IIC T3 Gb , and is suitable for use in Zone 1 and Zone 2 hazardous areas. Electrical connections to the detector are made via the terminal block on the PCB shown below.

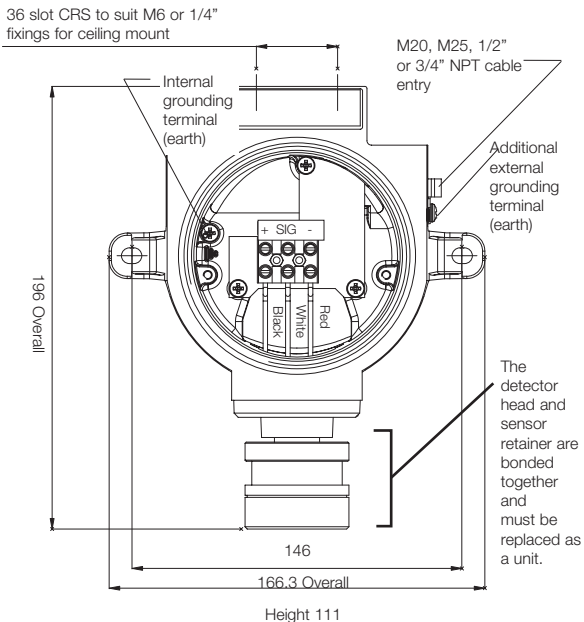



Diagram 10: **Xgard** Type 4 dimensioned view

WARNING

This detector is designed for use in Zone 1 and Zone 2 hazardous areas, and is certified  II 2 GD Ex d IIC T3 Gb. Installation must be in accordance with the recognised standards of the appropriate authority in the country concerned.

For further information please contact Crowcon. Prior to carrying out any installation work ensure local regulations and site procedures are followed.

2.1 Location

The detector should be mounted where the gas to be detected is most likely to be present. The following points should be noted when locating gas detectors:

- To detect gases which are lighter than air, detectors should be mounted at high level.
- To detect heavier than air gases, detectors should be mounted at low level.
- When locating detectors consider the possible damage caused by natural events e.g. rain or flooding.
- Consider ease of access for functional testing and servicing.
- Consider how the escaping gas may behave due to natural or forced air currents. Mount detectors in ventilation ducts if appropriate.
- Consider the process conditions. For example, butane is normally heavier than air, but if released from a process which is at an elevated temperature and/or pressure, the gas may rise rather than fall.

The placement of sensors should be determined following advice of experts having specialist knowledge of gas dispersion, the plant processing equipment as well as safety and engineering issues. **The agreement reached on the locations of sensors should be recorded.** Crowcon would be pleased to assist in the selection and siting of gas detectors.

2.2 Mounting

Xgard should be installed at the designated location with the sensor pointing down. This ensures that dust or water will not collect on the sensor and stop gas entering the cell. The mounting detail is shown in Diagram 2. Care should be taken when installing the detector to avoid damaging the painted surface of the junction box and sensor retainer.

2.3 Cabling requirement

Cabling to **Xgard** must be in accordance with the recognised standards of the appropriate authority in the country concerned and meet the electrical requirements of the detector.

Crowcon recommend the use of steel wire armoured (SWA) cable and suitable explosion proof glands must be used. Alternative cabling techniques, such as steel conduit, may be acceptable provided appropriate standards are met. The cable selected must be suitable for use in temperatures of up to 150°C (302°F).

Maximum permissible cable lengths depend on the cable resistance and sensor being used. It is important that the correct bridge voltage be applied to the detector. This will vary depending on the part number of the sensor fitted (see 'Sensor type' on the label fitted to the junction box). Table 5 below summarises the bridge voltage requirements.

Detector Part No.	Pellistor Type	Bridge Volts (Vdc)	Comment
S011954	VQ21T	2.0	Poison resistant

Table 5: Bridge voltage settings

The following cable lengths are calculated assuming a 300mA constant current drive, with a minimum supply of 18 V dc from the control equipment:

C.S.A.		Resistance (Ohms per km)		Max. Distance (km)	Max. Distance (km)
mm ² Awg		Cable	Loop	2.0 volt pellistors	2.5 volt pellistors
1.0	17	18.1	36.2	1.47	1.42
1.5	15	12.1	24.2	2.2	2.13
2.5	13	7.4	14.8	3.6	3.5

Table 6: maximum cable distances for typical cables

The acceptable cross sectional area of cable used is 0.5 to 2.5mm² (20 to 13awg). **The table is provided for guidance only, actual cable parameters for each application should be used to calculate maximum cable distances.**

2.4 Electrical connections

All connections are made via the screw terminal block mounted on the PCB in the junction box. The terminals are marked '+', 'sig' and '-' and correct polarity should be observed when connecting the detector to control equipment. This version of **Xgard** operates as part of a 3-wire mV Wheatstone bridge circuit and must be connected to a suitable control card.

Note: The internal grounding terminal (see diagram 10) shall be used as the grounding means of the **Xgard** gas detector. The external grounding terminal (see diagram 10) is only a supplemental bonding connection, and is only to be used where local authorities permit or require such a connection. To limit radio frequency interference, the junction box and cable armour should be grounded (earthed) at the control panel. Ensure the earth connection is provided in a safe area only, so as to avoid earth loops.

Xgard Type 4 PCB

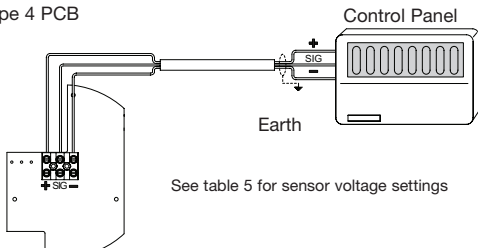

Diagram 11: Xgard Type 4 electrical connections

WARNING

Prior to carrying out any work ensure local regulations and site procedures are followed. Never attempt to open the detector or junction box when flammable gas is present. Ensure that the associated control panel is inhibited so as to prevent false alarms.

3.1 Commissioning procedure

1. Open the junction box of the detector by unscrewing the lid in an anti-clockwise direction (having loosened the retaining grub-screw first).
2. Check that all electrical connections have been made and are correct as per Diagram 11.
3. Measure the voltage across the '+' and '-' terminals and adjust according to the type of pellistor fitted (see Table 5).
4. Leave the detector to stabilise for at least 1 hour.
5. Balance the WB circuit at the control panel if necessary. Refer to the control equipment instruction manual.

Zeroing the detector

6. Ensure you are in clean air. Adjust the control equipment to read zero.

Calibrating the detector

7. Apply calibration gas (concentration should be 50% LEL) to the detector at a flow rate of 0.5 - 1 litre/minute via a flow adaptor (**Part No. C01886**). Contact Crowcon for the supply of calibration gas.
8. Allow the gas reading to stabilise (usually 30 to 60 seconds) and adjust the control equipment to read 50% LEL.
9. Remove the gas and allow the sensor to completely settle before re-checking the zero setting.
10. Close the junction box of the detector ensuring that the lid is securely tightened, and the grub-screw is secured.
11. The detector is now operational.

Note: Where possible, Crowcon recommends that Xgard Type 4 detectors are calibrated at the temperature at which they normally operate.

3.2 Routine maintenance

Pellistors can suffer from loss of sensitivity when there is a presence of poisons or inhibitors such as silicones, sulphides, chlorine, lead or halogenated hydrocarbons. Crowcon use poison resistant pellistors to maximise the operational life of **Xgard**. In applications where such compounds are continuously present we recommend the use of Crowcon's fixed point infrared flammable gas detectors, which are immune to such poisons and inhibitors. Please contact Crowcon for further details.

The operational life of the pellistors depends on the application and amount of gas to which the pellistor has been exposed. Under normal conditions (6 monthly calibration with periodic exposure to CAL gas) the life expectancy is 3-5 years.

Site practices will dictate the frequency with which detectors are tested. Crowcon would recommend that detectors be gas tested at least every 6 months and re-calibrated as necessary. To re-calibrate a detector follow the steps given in 3.1.

Xgard Type 4 uses a high temperature detector, which incorporates a sinter. The detector has no user servicable parts, thus the complete unit must be replaced if it fails to calibrate during routine tests.

When performing maintenance on **Xgard**, ensure that the sensor retainer and junction box lid O-rings are present and in good condition to maintain the ingress protection of the product. See the 'Spare parts and accessories' section for the part numbers of replacement O-rings.

3.3 Sensor replacement/servicing of detectors

Xgard uses a modular design, which makes replacement of sensors extremely simple. **Xgard** Type 4 uses a high temperature detector, which must be replaced as a whole, complete with sensor retainer (see page 35).

A detailed view of **Xgard** Type 4 is given in Diagram 10.

The following procedure may be followed when servicing a **Xgard** Type 4.

WARNING

This work should be carried out by Crowcon or an approved service centre unless suitable training has been received.

1. Switch off and isolate power to the detector requiring attention.
2. Open the junction box of the detector by unscrewing the lid in an anti-clockwise direction (having loosened the retaining grub-screw first).
3. Loosen the terminals retaining the detector wires.
4. Loosen the grub-screw on the sensor retainer.
5. Unscrew the detector and sensor retainer.
6. Fit the replacement detector and sensor retainer taking care to ensure the wires do not become twisted. Ensure the new detector is securely tightened.
7. Secure the sensor retainer grub-screw.
8. Re-connect the detector wires as shown in Diagram 10.
9. Follow the commissioning procedure given in 3.1.

Storage Instructions: The sensor used in this detectors should be stored in a dry environment, and protected from exposure to silicones, sulphides, chlorines and lead. Exposure to these compounds will significantly reduce the sensitivity of the sensor, and render the sensor warranty void.

Junction box material	Corrosion resistant alloy with polyester powder coating 316 Stainless Steel (optional)
Dimensions	195 x 166 x 111 mm (7.6 x 6.5 x 4.3 inches)
Weight	Alloy: 1.5 kg (3.3 lbs) Stainless Steel: 3.6 kg (7.9lbs).
Electrical output	3-wire mV bridge. Typically 10 mV per % CH ₄ (Minimum)
Operating temperature	-20°C to +150°C (-4°F to +302°F)
Humidity	0–99% RH, non condensing
Degree of protection	IP54
Explosion protection	Flameproof
Approval code	ATEX Ⓜ II 2 GD Ex d IIC T3 Gb Tamb -40°C to +150°C Extb IIIC T180°C Db
Safety certificate no.	Baseefa04ATEX0024X/1
Standards	EN60079-0:2012, EN60079-1:2007, EN60079-31:2009 IEC 60079-0:2011 (Ed 6), IEC60079-1: 2007 (Ed 6), IEC60079-31:2008 (Ed 1) UL1203
Zones	Certified for use in Zones 1 & 2 (Gas), and Zones 21 & 22 (Dust)
Gas groups	IIA, IIB, IIC
EMC	EN50270

1.1 Flameproof flammable gas detector

This version of **Xgard** is a Flameproof gas detector, designed to detect flammable gas present in ambient air, at concentrations not exceeding the Lower Explosive Limit (LEL) of the target gas for which it is calibrated. **Xgard** Type 5 is powered by 24 V dc (nominally) and provides a 4-20 mA signal (sink or source) proportional to the gas concentration. The detector is certified $\text{Ex II 2 GD Ex d IIC T6 Gb}$, and is suitable for use in Zone 1 and Zone 2 hazardous areas.

Electrical connections to the detector are made via the terminal block on the PCB shown below.

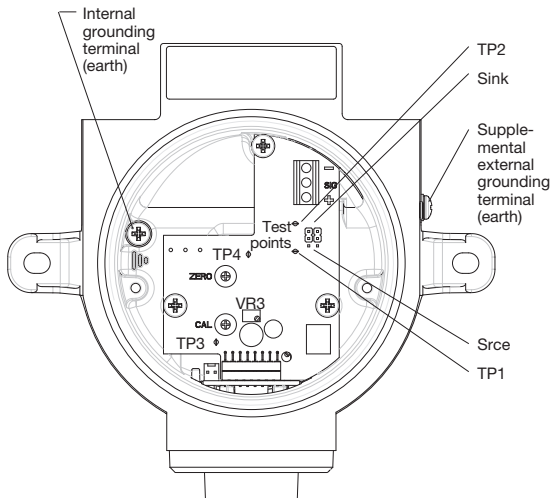

Diagram 12: **Xgard** Type 5 PCB layout
(Shown with PCB cover removed).

WARNING

This detector is designed for use in Zone 1 and Zone 2 hazardous areas, and is certified Ⓜ II 2 GD Ex d IIC T6 Gb. Installation must be in accordance with the recognised standards of the appropriate authority in the country concerned.

For further information please contact Crowcon. Prior to carrying out any installation work ensure local regulations and site procedures are followed.

2.1 Location

The detector should be mounted where the gas to be detected is most likely to be present. The following points should be noted when locating gas detectors:

- To detect gases which are lighter than air, detectors should be mounted at high level and Crowcon recommend the use of a collector cone (**Part No. C01051**) and accessory adaptor (**Part No. M04666**).
- To detect heavier than air gases, detectors should be mounted at low level.
- When locating detectors consider the possible damage caused by natural events e.g. rain or flooding. For detectors mounted outdoors Crowcon recommend the use of a Spray Deflector (**Part No. C01052**) and accessory adaptor (**Part No. M04666**).
- Consider ease of access for functional testing and servicing.
- Consider how the escaping gas may behave due to natural or forced air currents. Mount detectors in ventilation ducts if appropriate.
- Consider the process conditions. For example, butane is normally heavier than air, but if released from a process which is at an elevated temperature and/or pressure, the gas may rise rather than fall.

The placement of sensors should be determined following advice of experts having specialist knowledge of gas dispersion, the plant processing equipment as well as safety and engineering issues. **The agreement reached on the locations of sensors should be recorded.** Crowcon would be pleased to assist in the selection and siting of gas detectors.

2.2 Mounting

Xgard should be installed at the designated location with the sensor pointing down. This ensures that dust or water will not collect on the sensor and stop gas entering the cell. The mounting detail is shown in Diagram 2. Care should be taken when installing the detector to avoid damaging the painted surface of the junction box and sensor retainer.

2.3 Cabling requirement

Cabling to **Xgard** must be in accordance with the recognised standards of the appropriate authority in the country concerned and meet the electrical requirements of the detector.

Crowcon recommend the use of steel wire armoured (SWA) cable and suitable explosion proof glands must be used. Alternative cabling techniques, such as steel conduit, may be acceptable provided appropriate standards are met.

Xgard Type 5 requires a dc supply of 10-30 V, at up to 100 mA. Ensure there is a minimum of 10 V at the detector, taking into account the voltage drop due to cable resistance. For example, a nominal dc supply at the control panel of 24 V has a guaranteed minimum supply of 18 V. The maximum voltage drop is therefore 8 V. **Xgard** Type 5 can demand up to 100 mA and so the maximum loop resistance allowed is 80 Ohms.

A 1.5 mm² cable will typically allow cable runs up to 3.3 km. Table 7 below shows the maximum cable distances given typical cable parameters.

C.S.A.	Resistance (Ohms per km)			Max. Distance (km)
	Awg	Cable	Loop	
1.0	17	18.1	36.2	2.2
1.5	15	12.1	24.2	3.3
2.5	13	7.4	14.8	5.4

Table 7: maximum cable distances for typical cables

The acceptable cross sectional area of cable used is 0.5 to 2.5 mm² (20 to 13awg). **The table is provided for guidance only, actual cable parameters for each application should be used to calculate maximum cable distances.**

2.4 Electrical connections

All connections are made via the screw terminal block mounted on the PCB in the junction box. The terminals are marked '+', 'sig' and '-' and correct polarity should be observed when connecting the detector to control equipment. **Xgard** Type 5 is factory set as a 'current sink' device unless otherwise specified when ordering. To reset to 'current source', open the junction box and move the two links on the amplifier PCB from the 'sink position to the 'srce' position, as shown in Diagram 12.

Note: The internal grounding terminal (see diagram 12) shall be used as the grounding means of the **Xgard** gas detector. The external grounding terminal (see diagram 12) is only a supplemental bonding connection, and is only to be used where local authorities permit or require such a connection. To limit radio frequency interference, the junction box and cable armour should be grounded (earthed) at the control panel. Ensure the earth connection is provided in a safe area only, so as to avoid earth loops.

Xgard Type 5 PCB

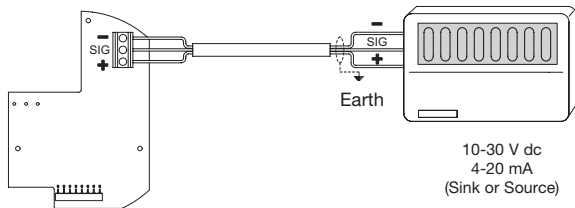

Diagram 13: **Xgard** Type 5 electrical connections

WARNING

Prior to carrying out any work ensure local regulations and site procedures are followed. Never attempt to open the detector or junction box when flammable gas is present. Ensure that the associated control panel is inhibited so as to prevent false alarms.

3.1 Commissioning procedure

1. Open the junction box of the detector by unscrewing the lid in an anti-clockwise direction (having loosened the retaining grub-screw first).
2. Check that all electrical connections have been made and are correct, as shown in Diagram 13.
3. Measure the voltage across the '+' and '-' terminals and check a minimum supply of 10 V dc. is present.
4. Leave the detector to stabilise for at least 1 hour.
5. Before calibration of the detector can commence, the pellistors must be balanced. To do this remove the PCB cover, and connect a digital volt meter (DVM) to the test points marked 'TP3' and 'TP4' on the amplifier PCB, as shown in Diagram 12). The DVM should be set to the dc mV range, and the potentiometer marked 'VR3' should be adjusted until the DVM reads 0.00 mV. The PCB cover can now be replaced.
6. To zero the detector, reconnect the DVM to the test points marked 'TP1' and 'TP2' on the amplifier PCB, as shown in Diagram 12.

Note: At the test points, Zero will read 40 mV = 4 mA.

Full scale deflection (100% LEL) will read 200 mV = 20 mA. There is a current clamp of 25 mA on the 4-20 mA output.

Zeroing the detector

7. **Ensure you are in clean air.** Adjust the 'ZERO' pot on the amplifier (which is accessible via a hole in the PCB cover) until the DVM reads 40 mV. Check that the control equipment display reads zero.

Calibrating the detector

8. Apply calibration gas (concentration should be 50% LEL) to the detector at a flow rate of 0.5 - 1 litre/minute via a flow adaptor (**Part No. C03005**). Contact Crowcon for the supply of calibration gas.
9. Allow the gas reading to stabilise (usually 30 to 60 seconds) and adjust the 'CAL' pot until the DVM reads the appropriate reading (ie 120 mV = 12 mA = 50% LEL). If the concentration of the calibration gas used is not 50% LEL, the following formula can be used to calculate the reading:

$$\left(\frac{160}{\text{Range}} \times \text{Gas} \right) + 40 = \text{mV setting}$$

Example: calibrating using 25% LEL test gas

$$\left(\frac{160}{100} \times 25 \right) + 40 = 80 \text{ mV}$$

10. If the control equipment display requires adjustment consult the operating manual for the equipment.
11. Remove the gas and allow the sensor to completely settle before re-checking the zero setting.
12. Close the junction box of the detector ensuring that the lid is securely tightened, and the grub-screw is secured.
13. The detector is now operational.

Note: ATEX certified Xgard flammable gas detectors will be supplied calibrated for compliance with EN60079-20-1 (where for example 100% LEL methane = 4.4% volume). UL certified detectors will be supplied calibrated for compliance with North American standards (where 100% LEL methane = 5% volume).

For further advice on balancing the amplifier and sensor module, especially where signal drift appears to have occurred, please contact Crowcon.

3.2 Routine maintenance

Pellistors can suffer from loss of sensitivity when there is a presence of poisons or inhibitors such as silicones, sulphides, chlorine, lead or halogenated hydrocarbons. Crowcon use poison resistant pellistors to maximise the operational life of **Xgard**. In applications where such compounds are continuously present we recommend the use of Crowcon's fixed point infrared flammable gas detectors, which are immune to such poisons and inhibitors. Please contact Crowcon for further details.

The operational life of the pellistors depends on the application and amount of gas to which the pellistor has been exposed. Under normal conditions (6 monthly calibration with periodic exposure to CAL gas) the life expectancy is 3-5 years.

Site practices will dictate the frequency with which detectors are tested. Crowcon would recommend that detectors be gas tested at least every 6 months and re-calibrated as necessary. To re-calibrate a detector follow the steps given in 3.1.

The sinter should be inspected regularly, and replaced if it has become contaminated. A blocked sinter may prevent gas from reaching the sensor.

When performing maintenance on **Xgard**, ensure that the sensor retainer and junction box lid O-rings are present and in good condition to maintain the ingress protection of the product. See the 'Spare parts and accessories' section for the part numbers of replacement O-rings.

3.3 Sensor replacement/servicing of detectors

Xgard uses a modular design, which makes replacement of sensors, or sinters extremely simple. Replacement sensors are supplied fitted to a sensor PCB to allow simple plug-in installation. An exploded view of **Xgard** is given in Diagram 3. The following procedure may be followed when servicing a **Xgard** detector.

WARNING



This work should be carried out by Crowcon or an approved service centre unless suitable training has been received.

1. Switch off and isolate power to the detector requiring attention.
2. Open the junction box of the detector by unscrewing the lid in an anti-clockwise direction (having loosened the retaining grub-screw first).
3. Unscrew the sensor retainer and remove the sensor and sensor PCB.
4. Fit the replacement sensor (having checked that the part number matches that stated on the detector junction box label), taking care to align the locating pins correctly with the slots in the junction box.
5. Re-fit the sensor retainer having first inspected the sinter to make sure that it has not become contaminated. Contaminated items should be replaced (see Spare Parts section for replacement part numbers), as any blockages may result in slow sensor response to gas, and reduced sensitivity.
6. Follow the Commissioning Procedure given in 3.1.

Sensor Part No.	Pellistor Type	Bridge Volts (Vdc)	Comment
Contact Crowcon VQ21T		2.0	Standard for CH ₄
Contact Crowcon 300P		2.0	Alternative for CH ₄
Contact Crowcon VQ8		2.5	Lead resistant for leaded petrol
Contact Crowcon VQ25		2.0	For halogens
Contact Crowcon VQ41		2.0	For Jet fuel
Contact Crowcon VQ41		2.0	For Ammonia

Table 8: Sensor options, please contact Crowcon for advice on alternative gases or vapours.

Storage Instructions: The sensor used in this detectors should be stored in a dry environment, and protected from exposure to silicones, sulphides, chlorines and lead. Exposure to these compounds will significantly reduce the sensitivity of the sensor, and render the sensor warranty void.

Junction box material	Corrosion resistant alloy with polyester powder coating 316 Stainless Steel (optional)
Dimensions	156 x 166 x 111 mm (6.1 x 6.5 x 4.3 inches)
Weight	Alloy: 1 kg (2.2 lbs) Stainless Steel: 3.1 kg (6.8lbs) approx.
Operating voltage	10-30 V dc
Current consumption	100 mA @ 10 V 50 mA @ 24 V
Output	4-20 mA Sink or Source (Selected by Links)
Fault signal	< 3 mA
Maximum cable resistance	40 Ohms @ 18 V (power) +ve terminal 450 Ohms @ 18 V (signal) sig terminal Relative to -ve terminal (common)
Operating temperature	-40°C to +55°C (-40°F to +131°F)
Humidity	0–99% RH, non condensing
Degree of protection	IP65
Explosion protection	Flameproof
Approval code	ATEX  II 2 GD Ex d IIC T6 Gb Tamb -40°C to 50°C Extb IIIC T80°C Db ATEX  II 2 GD Ex d IIC T4 Gb Tamb -40°C to 80°C Extb IIIC T110°C Db IECEX BAS 05.0042 UL Class I, Division 1, Groups B, C & D IECEX BAS 05.0043X
Safety certificate no.	Baseefa04ATEX0024X
Standards	EN60079-0:2012, EN60079-1:2007, EN60079-31:2009 IEC 60079-0:2011 (Ed 6), IEC60079-1: 2007 (Ed 6), IEC60079-31:2008 (Ed 1) UL1203
Zones	Certified for use in Zones 1 & 2 (Gas), and Zones 21 & 22 (Dust)
Gas groups	IIA, IIB, IIC (UL groups B,C,D)
EMC	EN50270

1.1 Flameproof thermal conductivity type gas detector

This version of **Xgard** is a Flameproof thermal conductivity type gas detector, designed to monitor binary gas mixtures (such as hydrogen in nitrogen, methane in carbon dioxide) in % volume concentrations. The detector relies on there being a substantial difference in the thermal conductivity properties of the gases in the mixture being monitored. Precautions should be taken to ensure that humidity in the gas mixture is kept to a minimum, and the operating temperature remains stable, otherwise the sensor readings may be affected. For a list of gas mixtures that can be detected using **Xgard** Type 6 please contact Crowcon. **Xgard** Type 6 is powered by 24 V dc (nominally) and provides a 4-20 mA signal (sink or source) proportional to the gas concentration. The detector is certified Ex II 2 GD Ex d IIC T6 Gb, and is suitable for use in Zone 1 and Zone 2 hazardous areas.

Electrical connections to the detector are made via the terminal block on the PCB shown below.

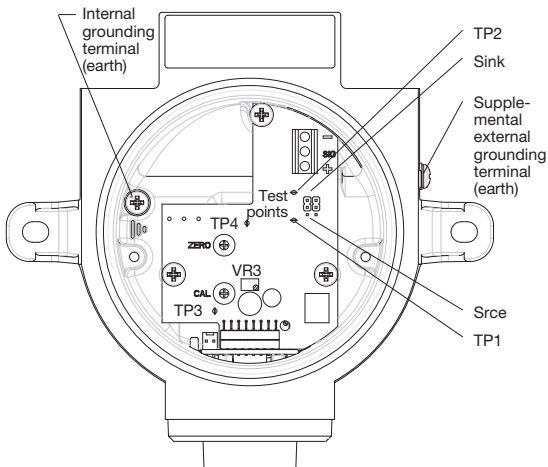

Diagram 14: **Xgard** Type 6 PCB layout
(Shown with PCB cover removed).

WARNING

This detector is designed for use in Zone 1 and Zone 2 hazardous areas, and is certified Ex d IIC T6 Gb . Installation must be in accordance with the recognised standards of the appropriate authority in the country concerned.

For further information please contact Crowcon. Prior to carrying out any installation work ensure local regulations and site procedures are followed.

2.1 Location

The detector should be mounted where the gas to be detected is most likely to be present. The following points should be noted when locating gas detectors:

- To detect gases which are lighter than air, detectors should be mounted at high level and Crowcon recommend the use of a collector cone (**Part No. C01051**) and accessory adaptor (**Part No. M04666**).
- To detect heavier than air gases, detectors should be mounted at low level.
- If the detector is to be used to monitor gas in a sample line rather than ambient conditions, a flow adaptor is available for 6mm (1/4") o/d pipe (**Part No. C01339**). Crowcon recommend a flow rate of 0.5 - 1 litre/minute, and the sample gas must be suitably filtered to remove dust and moisture.
- When locating detectors consider the possible damage caused by natural events e.g. rain or flooding. For detectors mounted outdoors Crowcon recommend the use of a Spray Deflector (**Part No. C01052**) and accessory adaptor (**Part No. M04666**).
- Consider ease of access for functional testing and servicing.
- Consider how the escaping gas may behave due to natural or forced air currents. Mount detectors in ventilation ducts if appropriate.
- Consider the process conditions. For example, butane is normally heavier than air, but if released from a process which is at an elevated temperature and/or pressure, the gas may rise rather than fall.

The placement of sensors should be determined following advice of experts having specialist knowledge of gas dispersion, the plant processing equipment as well as safety and engineering issues. **The agreement reached on the locations of sensors should be recorded.** Crowcon would be pleased to assist in the selection and siting of gas detectors.

2.2 Mounting

Xgard should be installed at the designated location with the sensor pointing down. This ensures that dust or water will not collect on the sensor and stop gas entering the cell. The mounting detail is shown in Diagram 2. Care should be taken when installing the detector to avoid damaging the painted surface of the junction box and sensor retainer.

2.3 Cabling requirement

Cabling to **Xgard** must be in accordance with the recognised standards of the appropriate authority in the country concerned and meet the electrical requirements of the detector.

Crowcon recommend the use of steel wire armoured (SWA) cable and suitable explosion proof glands must be used. Alternative cabling techniques, such as steel conduit, may be acceptable provided appropriate standards are met.

Xgard Type 6 requires a dc supply of 10-30 V, at up to 100 mA. Ensure there is a minimum of 10 V at the detector, taking into account the voltage drop due to cable resistance. For example, a nominal dc supply at the control panel of 24 V has a guaranteed minimum supply of 18 V. The maximum voltage drop is therefore 8 V. **Xgard** Type 6 can demand up to 100 mA and so the maximum loop resistance allowed is 80 Ohms. A 1.5 mm² cable will typically allow cable runs up to 3.3 km. Table 9 below shows the maximum cable distances given typical cable parameters.

C.S.A.		Resistance (Ohms per km)		Max. Distance
mm ²	Awg	Cable	Loop	(km)
1.0	17	18.1	36.2	2.2
1.5	15	12.1	24.2	3.3
2.5	13	7.4	14.8	5.4

Table 9: maximum cable distances for typical cables

The acceptable cross sectional area of cable used is 0.5 to 2.5 mm² (20 to 13awg). **The table is provided for guidance only, actual cable parameters for each application should be used to calculate maximum cable distances.**

2.4 Electrical connections

All connections are made via the screw terminal block mounted on the PCB in the junction box. The terminals are marked '+', 'sig' and '-' and correct polarity should be observed when connecting the detector to control equipment. **Xgard** Type 6 is factory set as a 'current sink' device unless otherwise specified when ordering. To reset to 'current source', open the junction box and move the two links on the amplifier PCB from the 'sink' position to the 'srce' position, as shown in Diagram 14.

Note: The internal grounding terminal (see diagram 14) shall be used as the grounding means of the **Xgard** gas detector. The external grounding terminal (see diagram 14) is only a supplemental bonding connection, and is only to be used where local authorities permit or require such a connection. To limit radio frequency interference, the junction box and cable armour should be grounded (earthed) at the control panel. Ensure the earth connection is provided in a safe area only, so as to avoid earth loops.

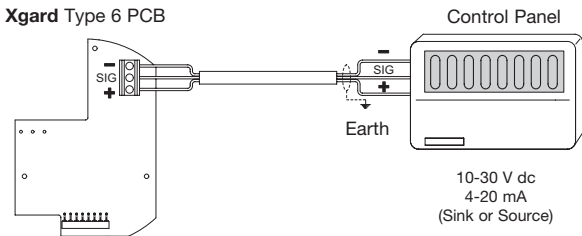

Diagram 15: **Xgard** Type 6 electrical connections

WARNING

Prior to carrying out any work ensure local regulations and site procedures are followed. Never attempt to open the detector or junction box when flammable gas is present. Ensure that the associated control panel is inhibited so as to prevent false alarms.

3.1 Commissioning procedure

1. Open the junction box of the detector by unscrewing the lid in an anti-clockwise direction (having loosened the retaining grub-screw first).
2. Check that all electrical connections have been made and are correct as per Diagram 15.
3. Measure the voltage across the '+' and '-' terminals and check a minimum supply of 10 V dc is present.
4. Leave the detector to stabilise for at least 1 hour.
5. Before calibration of the detector can commence, the thermal conductivity sensor must be balanced. To do this remove the PCB cover, and connect a digital volt meter (DVM) to the test points marked 'TP3' and 'TP4' on the amplifier PCB, as shown in Diagram 14. The DVM should be set to the dc mV range.

Check the detector label for details of the background gas. This is normally air, carbon dioxide, nitrogen or argon. Apply a sample of the background gas (100% volume concentration) to the sensor at a flow rate of 0.5 – 1 litre/minute via a flow adaptor (**Part No. C03005**). If the background gas is air, the sensor may simply be exposed to ambient **clean** air. The potentiometer marked 'VR3' should be adjusted until the DVM reads 0.00 mV. The PCB cover can now be replaced.

6. Reconnect the DVM to the test points marked 'TP1' and 'TP2' on the amplifier PCB, as shown in Diagram 14.

Note: At the test points, Zero will read 40 mV = 4 mA.

Full scale deflection will read 200 mV = 20 mA. There is a current clamp of 25 mA on the 4-20 mA output.

Zeroing the detector

7. Check the detector label for details of the background gas. This is normally air, carbon dioxide, nitrogen or argon. Apply a sample of the background gas (100% volume concentration) to the sensor at a flow rate of 0.5 – 1 litre/minute via a flow adaptor (**Part No. C03005**). If the background gas is air, the sensor may simply be exposed to ambient **clean** air. Adjust the 'ZERO' pot on the amplifier (which is accessible via a hole in the PCB cover) until the DVM reads 40 mV. Check that the control equipment display reads zero.

Calibrating the detector

8. Apply calibration gas (which should either be 100% volume target gas, or be a representative mix of the required range, for example 60% CH₄ / 40% CO₂) to the detector at a flow rate of 0.5 - 1 litre/minute via a flow adaptor (**Part No. C03005**). Contact Crowcon for the supply of calibration gas.
9. Allow the gas reading to stabilise (usually 30 to 60 seconds) and adjust the 'CAL' pot until the DVM reads the appropriate reading (200mV if 100% volume target gas is used). Use the following formula to calculate the DVM reading if the target gas concentration in the calibration gas is lower than 100% volume:

Where the 'Range' is the maximum value of the target gas, and 'Gas' is

$$\left(\frac{160}{\text{Range}} \times \text{Gas} \right) + 40 = \text{mV setting}$$

the concentration of the target gas in the calibration mixture.

Example: calibrating a detector to measure 0-100% volume methane in carbon dioxide, using 60% CH₄ / 40% CO₂ calibration gas:

10. If the control equipment display requires adjustment consult the

$$\left(\frac{160}{100} \times 60 \right) + 40 = 136 \text{ mV}$$

operating manual for the equipment.

11. Remove the gas and allow the sensor to completely settle before re-checking the zero setting.
12. Close the junction box of the detector ensuring that the lid is securely tightened, and the grub-screw is secured.
13. The detector is now operational.

Note: Xgard Type 6 will only measure reliably when exposed to a gas mixture for which it is calibrated. If, for example, a detector is calibrated for a CH₄ / CO₂ mixture, but exposed to air, erroneous signals will be produced.

For further advice on balancing the amplifier and sensor module, especially where signal drift appears to have occurred, please contact Crowcon.

3.2 Routine maintenance

The operational life of the sensor depends on the application for which it is being used. It is expected that a thermal conductivity sensor will work satisfactorily for up to 5 years in ideal conditions. Sensors are prone to damage by vibration and shock, so measures should be taken to ensure that the detector is not affected by these influences.

Site practices will dictate the frequency with which detectors are tested. Crowcon would recommend that detectors be gas tested at least every 6 months and re-calibrated as necessary. To re-calibrate a detector follow the steps given in 3.1.

The sinter should be inspected regularly, and replaced if it has become contaminated. A blocked sinter may prevent gas from reaching the sensor.

When performing maintenance on **Xgard**, ensure that the sensor retainer and junction box lid O-rings are present and in good condition to maintain the ingress protection of the product. See the 'Spare parts and accessories' section for the part numbers of replacement O-rings.



3.3 Sensor replacement/servicing of detectors

Xgard uses a modular design, which makes replacement of sensors, or sinters extremely simple. Replacement sensors are supplied fitted to a sensor PCB to allow simple plug-in installation. An exploded view of **Xgard** is given in Diagram 3. The following procedure may be followed when servicing a **Xgard** detector.

WARNING

This work should be carried out by Crowcon or an approved service centre unless suitable training has been received.

1. Switch off and isolate power to the detector requiring attention.
2. Open the junction box of the detector by unscrewing the lid in an anti-clockwise direction (having loosened the retaining grub-screw first).
3. Unscrew the sensor retainer and remove the sensor and sensor PCB.
4. Fit the replacement sensor (having checked that the part number matches that stated on the detector junction box label), taking care to align the locating pins correctly with the slots in the junction box.
5. Re-fit the sensor retainer having first inspected the sinter to make sure that it has not become contaminated. Contaminated items should be replaced (see Spare Parts section for replacement part numbers), as any blockages may result in slow sensor response to gas, and reduced sensitivity.
6. Follow the Commissioning Procedure given in 3.1.

Junction box material	Corrosion resistant alloy with polyester powder coating 316 Stainless Steel (optional)
Dimensions	156 x 166 x 111 mm (6.1 x 6.5 x 4.3 inches)
Weight	Alloy: 1 kg (2.2 lbs) Stainless Steel: 3.1 kg (6.8lbs) approx.
Operating voltage	10-30 V dc
Current consumption	100 mA @ 10 V 50 mA @ 24 V
Output	4-20 mA Sink or Source (Selected by Links)
Fault signal	< 3 mA
Maximum cable resistance	40 Ohms @ 18 V (power) +ve terminal 450 Ohms @ 18 V (signal) sig terminal Relative to -ve terminal (common)
Operating temperature	+10°C to +55°C (50°F to +131°F)
Humidity	0–90% RH, non condensing
Degree of protection	IP65
Explosion protection	Flameproof
Approval code	ATEX  II 2 GD Ex d IIC T6 Gb Tamb -40°C to 50°C Extb IIIC T80°C Db ATEX  II 2 GD Ex d IIC T4 Gb Tamb -40°C to 80°C Extb IIIC T110°C Db IECEX BAS 05.0042 UL Class I, Division 1, Groups B, C & D IECEX BAS 05.0043X
Safety certificate no.	Baseefa04ATEX0024X
Standards	EN60079-0:2012, EN60079-1:2007, EN60079-31:2009 IEC 60079-0:2011 (Ed 6), IEC60079-1: 2007 (Ed 6), IEC60079-31:2008 (Ed 1) UL1203
Zones	Certified for use in Zones 1 & 2 (Gas), and Zones 21 & 22 (Dust)
Gas groups	IIA, IIB, IIC (UL groups B, C, D)
EMC	EN50270

Spare parts and accessories

Please refer to the Sensor Type section on the main junction box label for the correct replacement sensor part number.

Description	Part Number	Xgard Version
Sensor retainer (aluminium)	S012132/S	Type 1 only (UL)
Sensor retainer (Glass-reinforced Nylon)	S012982	Type 1 only (ATEX)
Sensor retainer with sinter (aluminium)	S012133/S	Types 2,3,5,6*
Sensor seal (aluminium and Glass-reinforced Nylon)	M04885	All Types*
Sensor retainer (stainless steel)	M01945	Type 1
Sensor retainer with sinter (stainless steel)	M01932	Types 2,3,5,6
Sensor seal (stainless steel retainer)	M04971	Types 1,2,3,5,6
Sensor retainer O-ring (aluminium and stainless steel)	M04828	All Types*
Sensor retainer O-ring for Glass-reinforced Nylon	M04481	Type 1
Junction box lid O-ring	M04829	All Types*
Amplifier PCB for the following gas types: Carbon Monoxide, Chlorine, Chlorine Dioxide, Hydrogen, Hydrogen Sulphide, Nitrogen Dioxide, Sulphur Dioxide	S011238/2	Types 1 & 2
Amplifier PCB for the following gas types: Ammonia, Arsine, Bromine, Diborane, Fluorine Germane, Hydrogen Cyanide, Hydrogen Fluoride Ozone, Phosgene, Phosphine, Silane (Sensoric cells)	S011896/2	Types 1 & 2
Amplifier PCB (Oxygen)	S011240/2	Types 1 & 2
Amplifier PCB (flammable, bridge)	S011469/2	Type 3
Amplifier PCB (flammable, high temperature)	S011720	Type 4
Amplifier PCB (flammable, 4-20mA)	S011242/2	Type 5
Amplifier PCB (thermal conductivity, 4-20mA)	S011837	Type 6
PCB cover	M04770	All Types*
Calibration adaptor	C03005	All Types
Duct mounting kit	S011918	All Types*
Sensor retainer O-ring	M04909	Type 4
Junction box lid O-ring	M04910	Type 4

*Except Xgard Type 4



Accessory adaptor
C011061

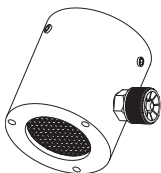

Spray deflector
C01052

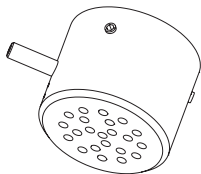

Weatherproof cap
C01442

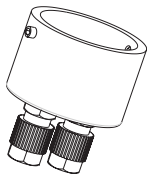

Flow adaptor
C01339



Collector cone
C01051

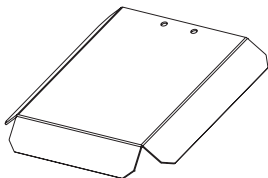

Sun Shade
C011063

Note: these accessories are not compatible with Xgard Type 4

Appendix: Sensor limitations

The sensors used in **Xgard** have limitations common to all such gas sensors, and users should be aware of the points listed below. Crowcon can advise on particular situations and suggest alternative sensors if the instrument is likely to experience extreme conditions.

- Electrochemical sensor performance changes at extremes of temperature; consult Crowcon if the detector will be exposed to ambient temperatures below -20°C or above +40°C (-4 and 104°F).
- Extreme levels of humidity can also cause problems. The sensors are rated for an (average) ambient of 15-90% R.H. However they are used from the tropics to deserts to tundra without this normally presenting a problem.
- Water, contaminants or paint should not be allowed to impede the sensor, as this will prevent gas diffusion. Detectors should be mounted with the sensor pointing down to help prevent this.
- Persistent exposure to certain compounds may contaminate the sensors. Calibration checks should be performed in accordance with the instructions for each detector type to ensure that the sensor is working correctly.
- Persistent exposure to high levels of toxic or flammable gas will shorten the life of the sensor. If the high level gas is corrosive (e.g. hydrogen sulphide) damage may occur over time to metal components.
- Sensors may be cross sensitive to other gases. If unsure, contact Crowcon or your local agent.
- **Storage Instructions:** Electrochemical sensors used in Xgard Types 1 and 2 have a maximum non-powered storage life of 3 months. Sensors stored within a detector for longer than 3 months prior to commissioning may not last for the full expected operational life. The warranty period for all sensors begins from the date of shipment from Crowcon. Detectors should be stored in a cool and dry environment where temperatures remain within the 0-20°C range.

There are no rules which dictate the siting and location of detectors, however considerable guidance is available from BS EN50073:1999 'Guide for Selection, Installation, Use and Maintenance of Apparatus for the Detection and Measurement of Combustible Gases or Oxygen'. Similar international codes of practice may be used where applicable. In addition certain regulatory bodies publish specifications giving minimum gas detection requirements for specific applications.

The detector should be mounted where the gas is most likely to be present.

Warranty

This equipment leaves our factory fully tested and calibrated. If within the warranty period of one year from Despatch, the equipment is proved to be defective by reason of faulty workmanship or material, we undertake at our option either to repair or replace it free of charge, subject to the conditions below.

Warranty Procedure

Your contact name, phone number, fax number and email address.

Description and quantity of goods being returned, including any accessories.

Instrument serial number(s).

Reason for return.

Obtain a Returns form for identification and traceability purpose. This form may be downloaded from our website 'crowconsupport.com', along with a returns label, alternatively we can 'email' you a copy.

Instruments will not be accepted for warranty without a Crowcon Returns Number ("CRN"). It is essential that the address label is securely attached to the outer packaging of the returned goods.

The guarantee will be rendered invalid if the instrument is found to have been altered, modified, dismantled, or tampered with. The warranty does not cover misuse or abuse of the unit.

Any warranty on batteries may be rendered invalid if the use of an unauthorized charger is proven. Non-rechargeable batteries are excluded from this warranty.

Warranties on sensors assume *normal* usage, and will be rendered invalid if the sensors have been exposed to excessive concentrations of gas, extended periods of exposure to gas or have been exposed to 'poisons' that can damage the sensor, such as those emitted by aerosol sprays

Warranty Disclaimer

Crowcon accept no liability for consequential or indirect loss or damage howsoever arising (including any loss or damage arising out of the use of the instrument) and all liability in respect of any third party is expressly excluded.

This warranty does not cover the accuracy of the calibration of the unit or the cosmetic finish of the product. The unit must be maintained in accordance with the Operating and Maintenance Instructions.

The warranty on replacement consumable items (such as sensors) supplied under warranty to replace faulty items, will be limited to the unexpired warranty of the original supplied item.

Crowcon reserves the right to determine a reduced warranty period, or decline a warranty period for any sensor supplied for use in an environment or for an application known to carry risk of degradation or damage to the sensor.

Our liability in respect of defective equipment shall be limited to the obligations set out in the guarantee and any extended warranty, condition or statement, express or

implied statutory or otherwise as to the merchantable quality of our equipment or its fitness for any particular purpose is excluded except as prohibited by statute. This guarantee shall not affect a customer's statutory rights.

Crowcon reserves the right to apply a handling and carriage charge whereby units returned as faulty, are found to require only normal calibration or servicing, which the customer then declines to proceed with.

A HALMA COMPANY



CE 1180

© 2015 Crowcon Detection Instruments Ltd.
Crowcon and Xgard are registered trade marks.