



Metasol

Meta Solution

Contactors and Overload relays



Metasol Contactors and Overload Relays

*New generation of Contactors
from LS Industrial Systems*



Metasol Contactors

Metasol Contactors

■ **Designed to show superior technology:
The Metasol series**

Sealed structure has improved its safety features so that no arc flash is exposed. In order to emphasize its durability as an industrial device, Metasol series adopt simple design form and sophisticated shape applying diamond cut concepts on product surface.



LSIS META SOLUTION CONTACTORS

Contents :



Metasol MC (3pole)

Table of specifications	10
Type numbering system	12
Environment	16
Connections	17
Control coil characteristics	18
Marking	20
Internal structure	21
Contactors (18~800AF)	22
Motor starters	40
Reversing contactors	44
Capacitive contactors	46
Accessory	48
Overload relays	58
Overload relay trip curves	74
Type 2 Coordination	82
Rated short circuit breaking capacity of installation	85
Dimension	86
Contact arrangement	104

Metasol MC (4pole)

Overview	108
Table of specifications	110
Dimension	114

Metasol Series completion

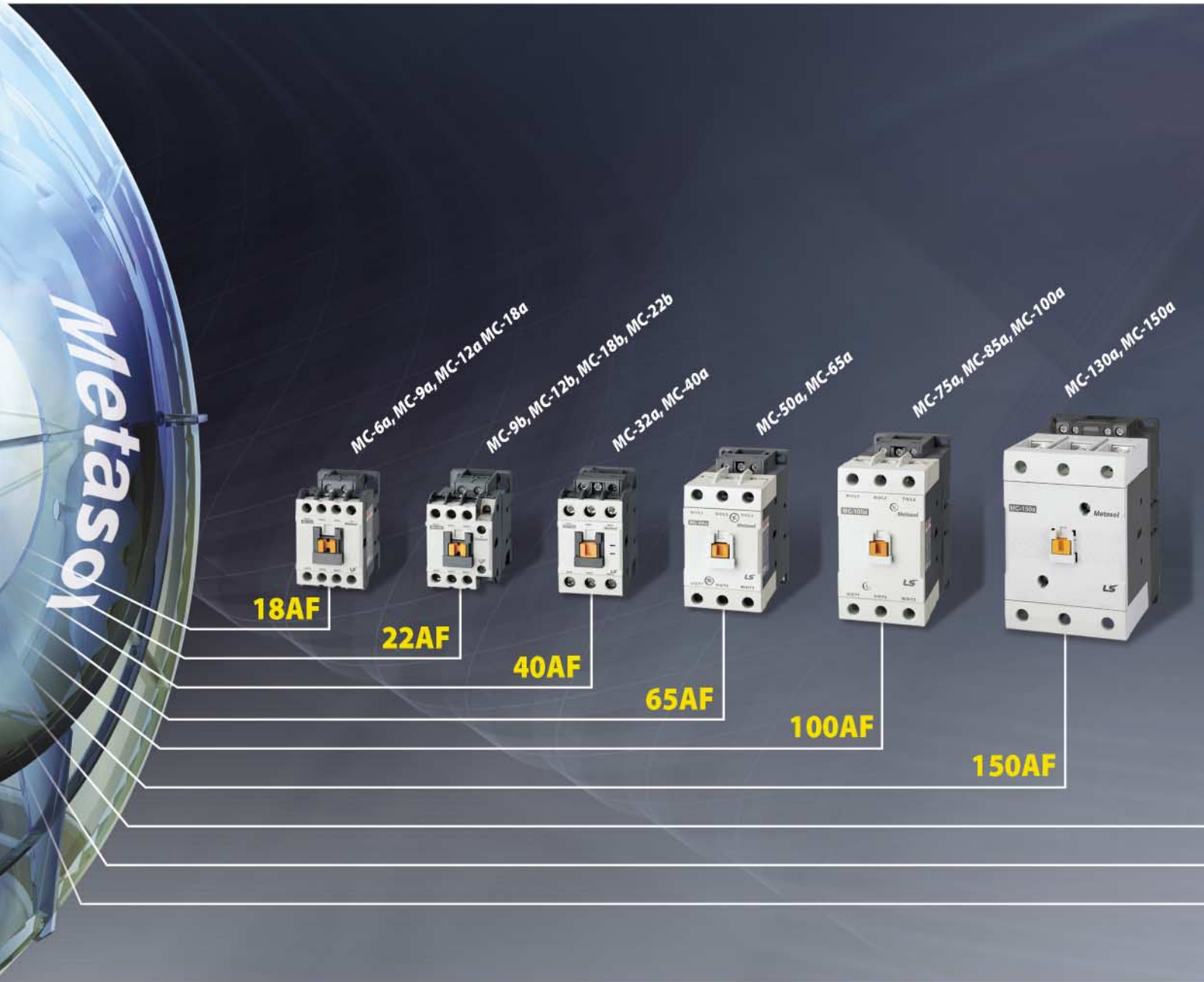

More Safe,
More Valuable



Contactors & Overload Relays



- *Advanced technology & Expert solution*
- *Offering economical solution with compact size & easy connection*
- *Ensure reliability in the system: Type II Coordination*
- *Perfect system with peripheral devices.*
- *Environment friendly product: complies with International environment standard RoHS.*
- *25 Models in 9 Frames*



MC/TOR

25 Models in 9 Frames

High reliability from optimum design

Metasol

Meta solution

- Compact design for space saving
- DIN rail and screw mountable
- Directly mountable overload relays provided separately
- Easy to combine with manual motor starters by using adapter and wiring kit
- Finger-proof design
- Broad range of accessories
- World class products conforming to IEC and UL standards

18AF

Contactor
MC-6a, 9a, 12a, 18a
 Rated current: 6, 9, 12, 18A
 Rated insulation voltage: 690V
 Type II : 30kA @415V Max.

Overload relay MT-12
 Current range: 0.1~18A
 Trip class: Class10A, 20



22AF

Contactor
MC-9b, 12b, 18b, 22b
 Rated current: 9, 12, 18, 22A
 Rated insulation voltage: 690V
 Type II : 30kA @415V Max.

Overload relay MT-32
 Current range: 0.1~40A
 Trip class: Class10A, 20



800AF

Contactor

MC-500a, 630a, 800a

Rated current: 500, 630, 800A
Rated insulation voltage: 1000V
Type II : 150kA @415V Max.

Overload relay MT-800

Current range: 200~800A
Trip class: Class10A, 20



400AF

Contactor

MC-265a, 330a, 400a

Rated current: 265, 330, 400A
Rated insulation voltage: 1000V
Type II : 150kA @415V Max.

Overload relay MT-400

Current range: 85~400A
Trip class: Class10A, 20



225AF

Contactor

MC-185a, 225a

Rated current: 185, 225A
Rated insulation voltage: 1000V
Type II : 150kA @415V Max.

Overload relay MT-225

Current range: 65~240A
Trip class: Class10A, 20



40AF

Contactor

MC-32a, 40a

Rated current: 32, 40A
Rated insulation voltage: 1000V
Type II : 50kA @415V Max.

Overload relay MT-32

Current range: 0.1~40A
Trip class: Class10A, 20



65AF

Contactor

MC-50a, 65a

Rated current: 50, 65A
Rated insulation voltage: 1000V
Type II : 100kA @415V Max.

Overload relay MT-63

Current range: 4~65A
Trip class: Class10A, 20



100AF

Contactor

MC-75a, 85a, 100a

Rated current: 75, 85, 100A
Rated insulation voltage: 1000V
Type II : 100kA @415V Max.

Overload relay MT-95

Current range: 7~100A
Trip class: Class10A, 20



150AF

Contactor

MC-130a, 150a

Rated current: 120, 150A
Rated insulation voltage: 1000V
Type II : 150kA @415V Max.

Overload relay MT-150

Current range: 34~150A
Trip class: Class10A, 20





MC/TOR Accessories

Perfect combination of peripheral
devices and various accessories

Offering economical solution with compact size & easy connection



Perfect system with other devices and accessories

■ One-touch connection

- Din Rail connection without any special tools
- Direct combine a surge unit

■ Simple wiring

- Mounting unit, Adapter
- Reversing wire set

■ Easy Maintenance

- 4-terminal type: Easy wiring of operation coil
- Module type of Screw terminal
- Interlock unit with built-in auxiliary contacts(2NO built-in)

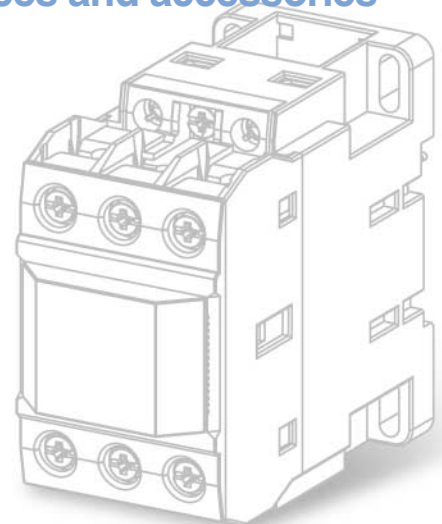

Advanced accessories for Metasol contactors

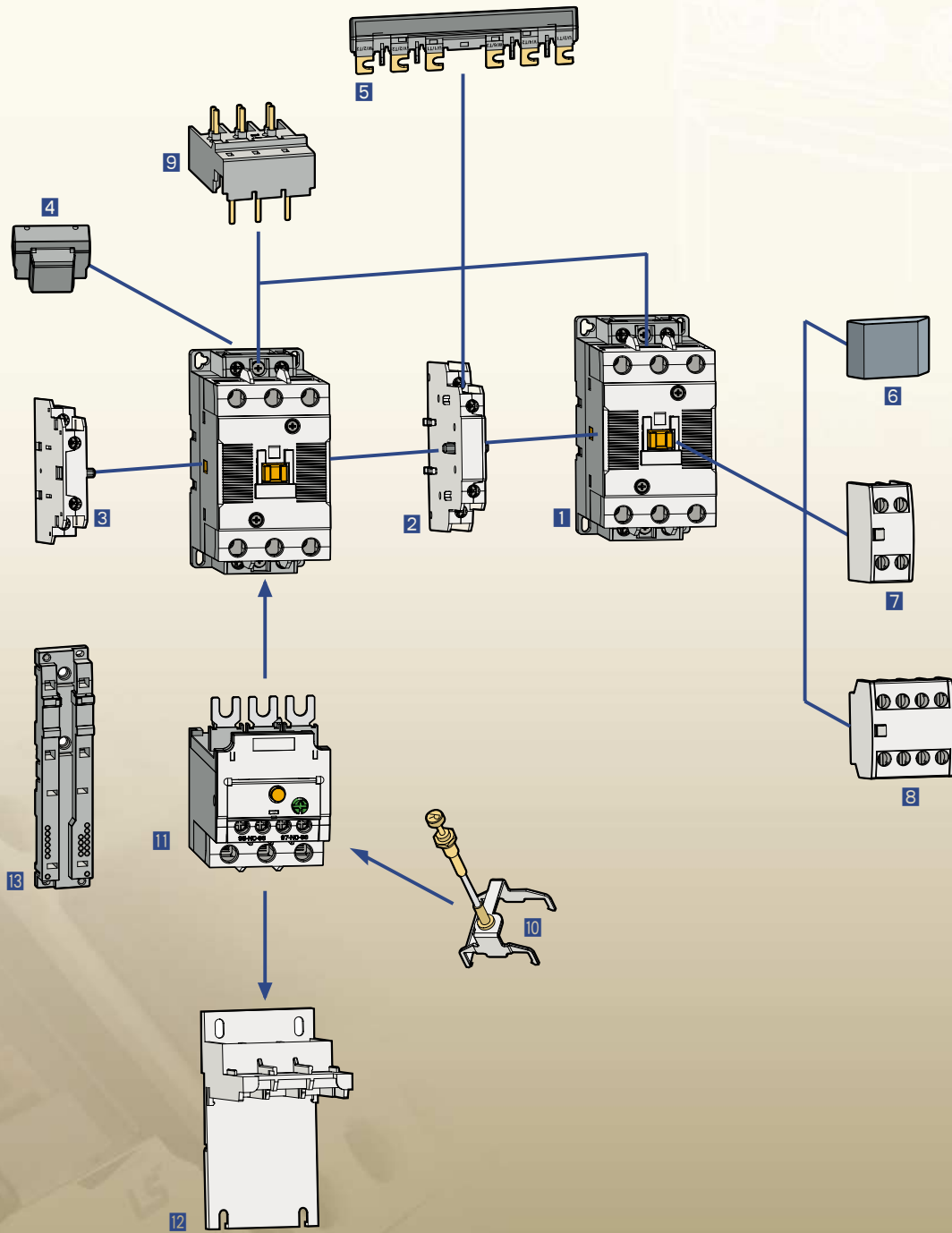

Accessory layout upto 150AF

- | | | |
|---|--|--|
| 1 Contactor | 6 Safety cover (Option) | 10 Remote reset unit |
| 2 Interlock unit | 7 Auxiliary contact unit
- front mount(2p) | 11 Overload relay |
| 3 Auxiliary contact unit
- side mount | 8 Auxiliary contact unit
- front mount(4p) | 12 Separate mounting unit |
| 4 Surge unit | 9 Direct adaptor to MMS | 13 Mounting unit for use with MMS |
| 5 Wire kit | | |

Table of specifications

MC type Magnetic Contactors



Frame size			18AF				22AF				
Type	screws clamp terminals		MC-6a	MC-9a	MC-12a	MC-18a	MC-9b	MC-12b	MC-18b	MC-22b*	
Number of poles			3pole				3pole				
Rated operational voltage, Ue			690V				690V				
Rated insulation voltage, Ui			690V				690V				
Rated frequency			50/60Hz				50/60Hz				
Rated impulse withstand voltage, Uimp			6kV				6kV				
Maximum operating rate in operating cycles per hour(AC3)			1800 operations per hour				1800 operations per hour				
Durability	Mechanical		15 mil. operations				15 mil. operations				
	Electrical		2.5 mil. operations				2.5 mil. operations				
Current and power	AC-1, Thermal current	A	25	25	25	32	25	25	32	40	
		AC-3	200/240V	kW	2.2	2.5	3.5	4.5	2.5	3.5	4.5
			A	9	11	13	18	11	13	18	22
		380/440V	kW	3	4	5.5	7.5	4	5.5	7.5	11
			A	7	9	12	18	9	12	18	22
		500/550V	kW	3	4	7.5	7.5	4	7.5	7.5	15
			A	6	7	12	13	7	12	13	20
		690V	kW	3	4	7.5	7.5	4	7.5	7.5	15
		A	4	5	9	9	6	9	9	18	
UL rating (50/60Hz)	Continuous current		A	25	25	25	32	25	25	40	40
	Single phase	110~120V	HP	0.5	0.5	0.75	1	0.5	0.75	1	2
		220~240V	HP	1.5	1.5	2	3	1.5	2	3	3
	Three phase	200~208V	HP	2	2	3	5	2	3	5	7.5
		220~240V	HP	3	3	5	7.5	3	5	7.5	10
		440~480V	HP	5	5	7.5	10	5	7.5	10	15
		550~600V	HP	7.5	7.5	10	15	7.5	10	15	20
NEMA size			00	00	0	0	00	00	0	1	
Size and weight	AC control	Weight	0.33				0.34				
		Size(W × H × D) mm	45 × 73.5 × 82				45 × 73.5 × 86				
	DC control	Weight	0.5				0.51				
		Size(W × H × D) mm	45 × 83 × 113.7				45 × 73.5 × 117.7				
Auxiliary(standard)			1a or 1b				1a1b				
Auxiliary	Side mount		UA-1				UA-1				
	Front mount		AU-2, AU-4				AU-2, AU-4				

Note) Minimum conduct current of Auxiliary contactor is DC 17V 5mA.

MT type Thermal Overload Relays



Type	Screws clamp terminals		MT-12/□		MT-32/□	
Rated operational voltage, Ue			690V		690V	
Rated insulation voltage, Ui			690V		690V	
Rated impulse withstand voltage, Uimp			6kV		6kV	
Trip class			10A, 20		10A, 20	
Setting range			0.1~18A		0.1~40A	
Size and weight	Weight	kg	0.1		0.17	
		Size(W × H × D) mm	45 × 73.2 × 63.7		45 × 75 × 90	

* The safety cover of magnetic contactor and thermal overload relay is optional.



40AF	
MC-32a	MC-40a
●	●
3pole	
690V	
1000V	
50/60Hz	
8kV	
1800 operations per hour	
12 mil. operations	
2 mil. operations	
50	60
7.5	11
32	40
15	18.5
32	40
18.5	22
28	32
18.5	22
20	23
50	60
2	3
5	7.5
7.5	15
10	15
20	30
25	30
1	1
0.55	
69 × 83 × 93	
0.77	
69 × 83 × 120	
UA-1	
AU-2, AU-4	



MT-32/□
●
690V
690V
6kV
10A, 20
0.1~40A
0.17
45 × 75 × 90



65AF	
MC-50a	MC-65a
●	●
3pole	
690V	
1000V	
50/60Hz	
8kV	
1800 operations per hour	
12 mil. operations	
2 mil. operations	
70	100
15	18.5
55	65
22	30
50	65
30	33
43	60
30	33
28	35
70	100
3	5
10	15
20	25
25	30
40	50
50	60
2	2
1.05	
79 × 106 × 122	
1.3	
79 × 106 × 149	
UA-1	
AU-2, AU-4	



MT-63/□
●
690V
690V
6kV
10A, 20
4~65A
0.31/0.33
55 × 81 × 100



100AF		
MC-75a	MC-85a	MC-100a
●	●	●
3pole		
690V		
1000V		
50/60Hz		
8kV		
1800 operations per hour		
12 mil. operations		
2 mil. operations		
110	135	160
22	25	30
75	85	105
37	45	55
75	85	105
37	45	55
64	75	85
37	45	45
42	45	65
110	135	160
5	7.5	10
15	15	20
25	30	30
30	40	40
50	60	75
60	75	75
2	3	3
1.93		
94 × 140 × 137		
2.8		
94 × 140 × 174		
UA-1		
AU-2, AU-4		



MT-95/□
●
690V
690V
6kV
10A, 20
7~100A
0.48/0.5
70 × 97 × 110

Table of specifications

MC type Magnetic Contactors



Frame size			150AF		225AF	
Type			MC-130a	MC-150a	MC-185a	MC-225a
screws clamp terminals			●	●	●	●
Number of poles			3pole		3pole	
Rated operational voltage, Ue			690V		690V	
Rated insulation voltage, Ui			1000V		1000V	
Rated frequency			50/60Hz		50/60Hz	
Rated impulse withstand voltage, Uimp			8kV		8kV	
Maximum operating rate in operating cycles per hour(AC3)			1200 operations per hour		1200 operations per hour	
Durability			5 mil. operations		5 mil. operations	
Electrical			1 mil. operations		1 mil. operations	
Current and power	AC-1, Thermal current	A	160	210	230	275
	AC-3	200/240V kW	37	45	55	75
		A	130	150	185	225
		380/440V kW	60	75	90	132
		A	130	150	185	225
		500/550V kW	60	70	110	132
	A	90	100	180	200	
	690V kW	55	55	110	140	
	A	60	60	120	150	
UL rating (50/60Hz)	Continuous current	A	160	210	230	275
	Single phase	110~120V HP	10	15	15	15
		220~240V HP	20	25	30	40
	Three phase	200~208V HP	40	40	60	60
		220~240V HP	40	50	60	75
		440~480V HP	75	100	125	150
	550~600V HP	75	75	125	150	
Size and weight	NEMA size		3	4	4	4
	AC control	Weight kg	2.4		5.4	
Size and weight	DC control	Weight kg	2.3		138 × 203 × 181	
	Size(W × H × D) mm		95 × 158 × 132			
Auxiliary(standard)			UA-1		2a2b	
Auxiliary	Side mount		AU-2, AU-4		AU-100 (Max.4NO4NC)	
	Front mount				-	

MT type Thermal Overload Relays



Type			MT-150/□	MT-225/□
Screws clamp terminals			●	●
Rated operational voltage, Ue			690V	690V
Rated insulation voltage, Ui			690V	690V
Rated impulse withstand voltage, Uimp			6kV	6kV
Trip class			10A, 20	10A, 20
Setting range			34~150A	65~240A
Size and weight	Weight	kg	0.67	2.5
	Size(W × H × D) mm		95 × 109 × 113	147 × 141 × 184

* The safety cover of magnetic contactor and thermal overload relay is optional.



400AF

MC-265a	MC-330a	MC-400a
●	●	●
3pole		
690V		
1000V		
50/60Hz		
8kV		
1200 operations per hour		
5 mil. operations		2.5 mil. operations
1 mil. operations		0.5 mil. operations
300	350	450
80	90	125
265	330	400
147	160	200
265	330	400
147	160	225
225	280	350
160	200	250
185	225	300
300	350	450
-	-	-
-	-	-
75	100	125
100	125	150
200	250	300
200	250	300
5	5	5

9.2
163 × 243 × 198

2a2b

AU-100 (Max.4NO4NC)



MT-400/□

●

690V

690V

6kV

10A, 20

85~400A

2.6

151 × 171 × 198



800AF

MC-500a	MC-630a	MC-800a
●	●	●
3pole		
690V		
1000V		
50/60Hz		
8kV		
1200 operations per hour		
2.5 mil. operations		0.5 mil. operations
580	660	900
147	190	220
500	630	800
265	330	440
500	630	800
265	330	500
400	500	720
300	400	500
380	420	630
580	660	900
-	-	-
-	-	-
150	200	200
200	250	300
400	500	600
400	500	600
6	6	7

22.4
285 × 312 × 242

2a2b

AU-100 (Max.4NO4NC)



MT-800/□

●

690V

690V

6kV

10A, 20

200~800A

11.5

360 × 530 × 212

Type numbering system

Contactors

MC-6a / **R** / **AC220** / **60Hz** / **1a1b** / **3Pole**

Rated current		Version		Coil voltage		Frequency		Auxiliary contact		No. of pole	
6a	6A	-	Standard	AC 220	AC 220V	60	60Hz	00	None	None	3Pole
⋮	⋮	R	Reversing	⋮	⋮	50	50Hz	11	1a1b	4P	4Pole *
800a	800A			DC 24	DC 24V			22	2a2b		
								10	1a(1NO)		
								01	1b(1NC)		

Note) See page 18, 19 for details.

Starters

MS-6a / **R** / **2H** / **AC220** / **60Hz** / **10** / **0.1**

Rated current		Contactor version		Relay version		Coil voltage		Frequency		Auxiliary contact		Relay setting current	
6a	6A	-	Standard	2H	Non-differential (2-heater)	AC 220	AC 220V	60	60Hz	00	None	0.1	0.1A
⋮	⋮	R	Reversing	3H	Non-differential (3-heater)	⋮	⋮	50	50Hz	11	1a1b	⋮	⋮
800a	800A			3K	Differential	DC 24	DC 24V			22	2a2b	800	800A
				3D	Class 20					10	1a(1NO)		
										01	1b(1NC)		

Note) See page 18, 19 for details.

Thermal Overload Relay

MT-12 / **2H** / **0.1**

Frame size		Relay version		Relay setting current	
12	12AF	2H	Non-differential (2-heater)	0.1	0.1A
32	32AF	3H	Non-differential (3-heater)	⋮	⋮
63	63AF	3K	Differential	800	800A
95	95AF	3D	Class 20		
⋮	⋮				
800	800AF				

Optional Accessories

Auxiliary contact unit

UA1

11

Version	
UA-1	Side mount
AU-100	
AU-2	Front mount(2P)
AU-4	Front mount(4P)

Contact composition	
11	1NO+1NC
20	2NO
02	2NC
40	4NO
31	3NO+1NC
22	2NO+2NC
13	1NO+3NC
04	4NC

Surge absorber

US11

Composition and voltage		
1	Varistor+RC	AC/DC 24~48V
2	Varistor+RC	AC/DC 100~125V
3	Varistor+RC	AC/DC 200~240V
4	Varistor+RC	AC 380~440V
5	Varistor+RC	AC 24~48V
6	Varistor+RC	AC 100~125V
11	Varistor	AC 200~240V
12	Varistor	DC 24~48V
13	Varistor	DC 100~125V
14	Varistor	DC 200~220V
22	RC	AC 100~125V

Note) See page 52 for details.

Interlock unit

UR02

Contact composition	
02	2NC
00	None

Wire kit for Interlocking

UW32

Frame size	
18	18AF
22	22AF
32	32AF
63	63AF
95	95AF

Interlock set (UR+UW)

RK32

Frame size	
32	32AF
63	63AF
95	95AF

Separate mounting unit (For relay)

UZ32

Frame size	
32	32AF
63	63AF
95	95AF
150	150AF

Remote reset unit (For relay)

UM

Cable length	
4R	400
5R	500
6R	600



















Environment



Standards	IEC/EN 60947-1, IEC/EN 60947-4-1, UL508, K60947
Certifications	CE, UL
Rated insulation voltage (Ui)	1000V
Rated impulse withstand voltage (Uimp)	8kV
Degree of protection	IP20 (Conforming to IEC60529)
Ambient air temperature	Storage: -50° C ~ +80° C
	Operation: -5° C ~ +60° C
Operating altitude	3000m (8900ft)
Operating positions	
Shock resistance (1/2 sine wave =11ms)	Opened: 8G
	Closed: 10G
Vibration resistance (Conforming to IEC68-2-6) (5...300 Hz)	Opened: 2G
	Closed: 4G
Flame resistance	Conforming to UL 94: Vo
	Conforming to IEC 695-2-1: 960° C

Connections

Connections

Wire type									Torque
		(mm ² /AWG)							[Nm][lb-in]
MC-18AF		1~6/18~10	1~6/18~10	1~6/18~10	1~6/18~10	1~6/18~10	1~10/18~8	up to 1.13/10	
MC-22AF		1~6/18~10	1~6/18~10	1~6/18~10	1~6/18~10	1~6/18~10	1~10/18~8	up to 2.25/20	
MC-40AF		1~6/18~10	2.5~10/14~8	2.5~10/14~8	2.5~10/14~8	2.5~10/14~8	1~10/18~8	up to 4/35	
MC-65AF		-	-	-	-	-	1~25/12~4	up to 4/35	
MC-100AF		-	-	-	-	-	1~25/12~4	up to 4/35	
MC-150AF		-	-	-	-	-	1~25/12~4	up to 9.8/87	
Coil terminal		0.5~2.5/20~14	0.75~25/18~12			0.5~25/20~12		up to 2.25/20	
MC-225AF		-	-	-	-	-	2.5~150/8~300	up to 14.7/130	
MC-400AF		-	-	-	-	-	2.5~200/8~700	up to 22.6/200	
MC-800AF		-	-	-	-	-	80~325/ 2/0~Busbar	up to 26.5/500	
Coil terminal		1.25~5.5/16~10	1.25~5.5/16~10			1.25~5.5/16~10		up to 1.75/15	

Control coil characteristics



Frame size		18AF	22AF	40AF	65AF	100AF	150AF
Type		MC-6a	MC-9b	MC-32a	MC-50a	MC-75a	MC-130a
		MC-9a	MC-12b	MC-40a	MC-65a	MC-85a	MC-150a
		MC-12a	MC-18b			MC-100a	
		MC-18a	MC-22b				
AC coil							
Control voltage	[Uc]	24, 32, 36, 42, 48, 80, 100, 110, 220, 230, 240, 380, 400, 415, 440, 500, 550V					24, 48, 110,
	50Hz [V]						220, 300,
	60Hz [V]	24, 48, 100, 110, 120, 200, 208, 220, 230, 240, 277, 380, 440, 480, 600V					400, 500
Voltage limit	50/60Hz [V]	24, 48, 100, 110, 120, 200, 220, 230, 240, 380, 415, 440, 500, 550V					
	Pick-up [Uc]	85 ~ 110% (50Hz)					
	Drop-out [Uc]	85 ~ 110% (60Hz)					
Coil consumption at 20°C		30 ~ 60%					
	AC 220V Inrush [VA]	58/56	58/56	53/50	110/104	229/216	108/104
	50/60Hz Holding [VA]	9.0/6.0	9.0/6.0	12.0/9.0	13.0/10.0	17.0/13.0	18.0/21.0
Heat dissipation [W]	2.1/1.5	2.1/1.5	2.7/2.2	2.8/2.4	5.4/4.7	2.7/3.6	
Operating time	Closing [ms]	12 ... 22	12 ... 22	12 ... 22	12 ... 22	15 ... 30	20 ... 40
	Opening [ms]	4 ... 19	4 ... 19	4 ... 19	4 ... 19	10 ... 30	60 ... 70
DC coil							
Control voltage [Uc]		12, 20, 24, 48, 60, 80, 100, 110, 125, 200, 220, 250					24, 48, 110, 220
Voltage limit [Uc]	Pick-up	70 ~ 110%					
	Drop-out	10 ~ 30%					
Coil consumption at 20°C	DC 110V Inrush [W]	9	9	7	9	18	213
	Holding [W]	9	9	7	9	18	7.5
Time constant (L/R) [ms]		28	28	28	65	75	
Operating time	Closing [ms]	35 ... 50	35 ... 50	50 ... 65	50 ... 65	100 ... 120	70 ... 80
	Opening [ms]	4 ... 19	4 ... 19	4 ... 19	4 ... 19	10 ... 25	60 ... 70

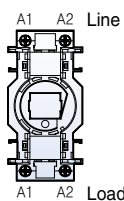

Note) A1(A2) in line side is internally connected to A1(A2) in load side.



Frame size		225AF	400AF	800AF
Type		MC-185a	MC-265a	MC-500a
		MC-225a	MC-330a MC-400a	MC-630a MC-800a
AC/DC common coil				
Control voltage	[Uc]			
	AC/DC	24/24	-	-
	AC/DC	48/48	-	100/100
	AC/DC	100~240/100~220	100~240/100~220	200/200
	AC	300	300	300
	AC	400	400	400
	AC	500	500	500
Voltage limit	[Uc]			
	Pick-up		86~110%	
	Drop-out		30~60%	
Coil consumption at 20°C				
AC 220V	Inrush [VA]	380	571	1000
50/60Hz	Holding [VA]	11.6	14	29
Heat dissipation	[W]	4.7	5	7.8
Operating time				
	Closing [ms]	70	55	75
	Opening [ms]	70	55	75

Marking

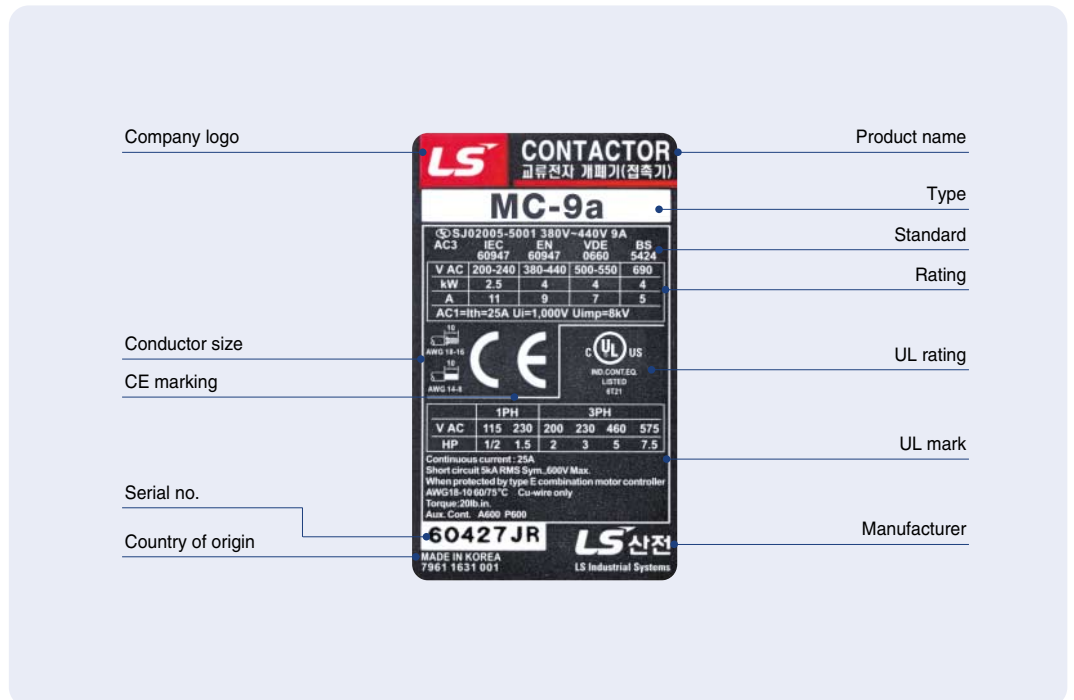
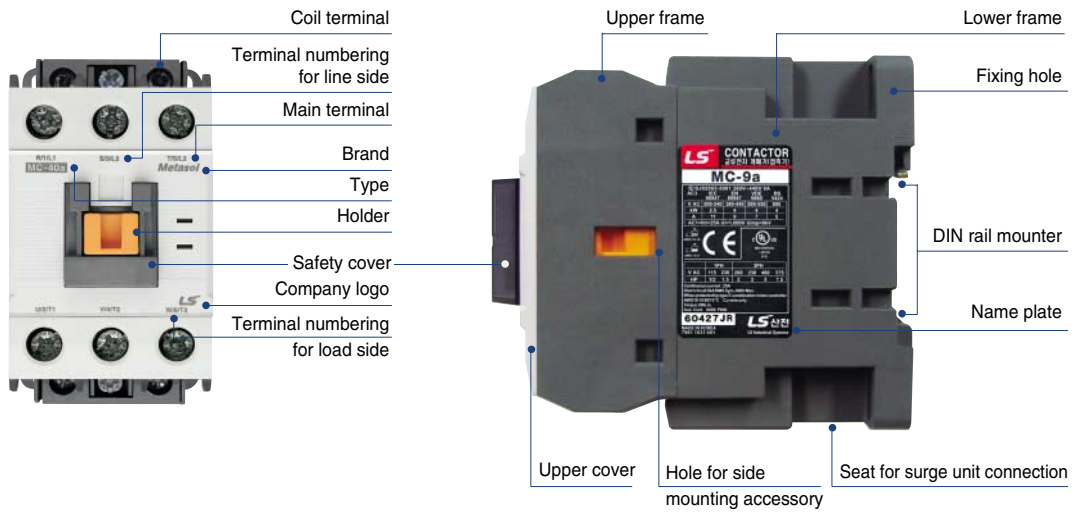

Internal structure

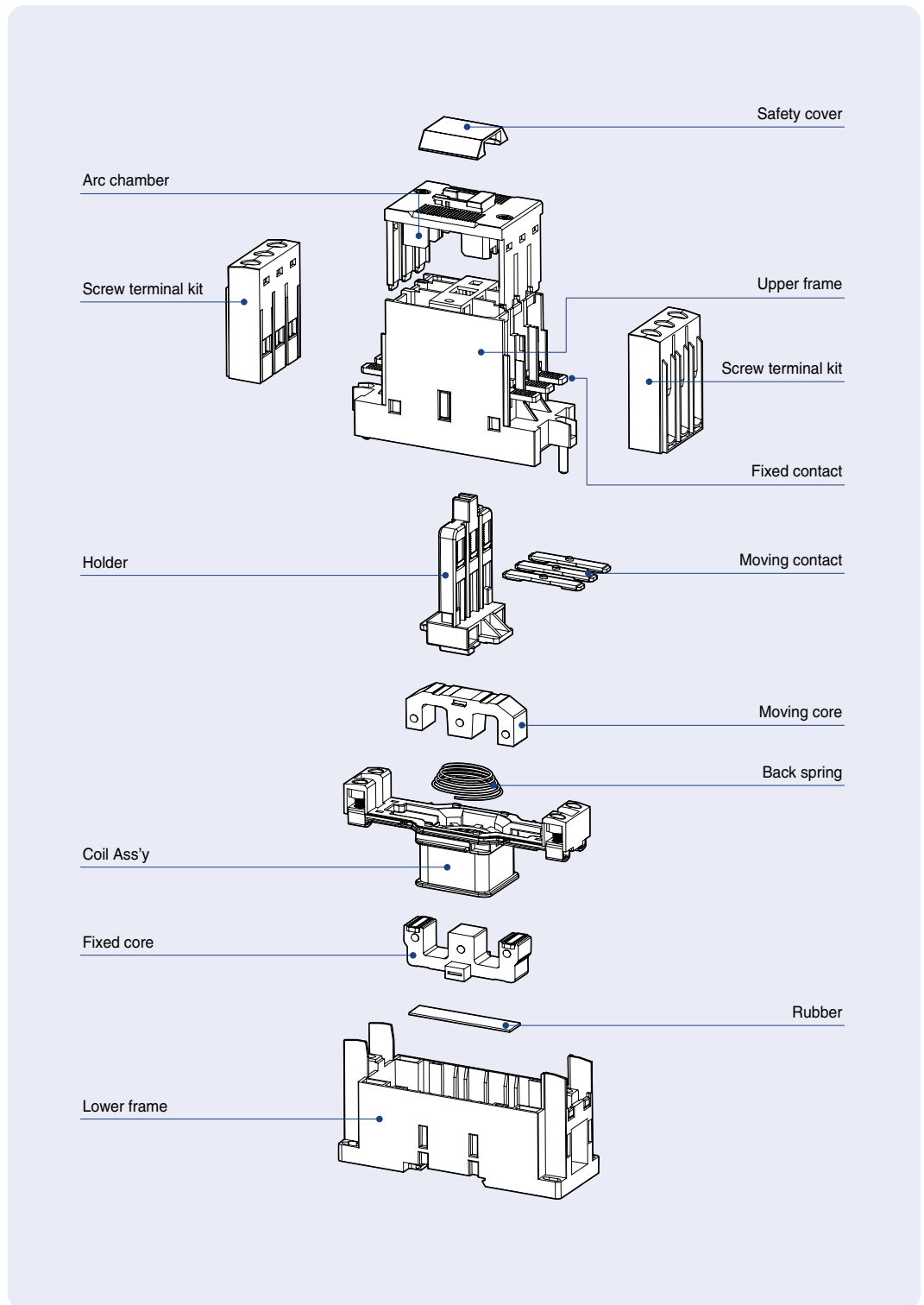

Contactors (18AF)

Description

- 3-pole(NO) main contact
- Finger proof design
- DIN rail or screw mountable
- AC or DC control in different physical size
- Front/side mountable accessories available
- Direct mountable overload relay available Rating
- 1NO or 1NC Auxiliary contact built-in as standard.

Rating



MC-18a

Contactor type			MC-6a		MC-9a		MC-12a		MC-18a		
			kW	A	kW	A	kW	A	kW	A	
AC duty	AC3	200/240V	2.2	9	2.5	11	3.5	13	4.5	18	
		380/440V	3	7	4	9	5.5	12	7.5	18	
		500/550V	3	6	4	7	7.5	12	7.5	13	
		690V	3	4	4	5	7.5	9	7.5	9	
	AC4	200/240V	1.5	7	1.5	8	2.2	11	3.7	16	
		380/440V	2.2	5	2.2	6	4	9	4	11	
AC1		-	25	-	25	-	25	-	32		
DC1 duty (L/R=1ms)	2-pole	24V	-	18	-	18	-	18	-	18	
		in series	48V	-	17	-	17	-	17	-	17
		110V	-	12	-	12	-	12	-	12	
	3-pole	24V	-	20	-	20	-	20	-	20	
		in series	48V	-	20	-	20	-	20	-	20
		110V	-	15	-	15	-	15	-	15	
DC2, 4 duty (L/R=15ms)	2-pole	24V	-	15	-	15	-	15	-	15	
		in series	48V	-	12	-	12	-	12	-	12
		110V	-	8	-	8	-	8	-	8	
	3-pole	24V	-	18	-	18	-	18	-	18	
		in series	48V	-	15	-	15	-	15	-	15
		110V	-	12	-	12	-	12	-	12	
Directly mountable Overload relay			MT-12								
Conductor size (solid, stranded) (the max. number of conducts: 2)	AWG		18~10		16~10		16~8		14~8		
	mm ²		1~4		1.5~4		1.5~10		2.5~10		
Conductor type			65/75°C Cu-wire only								



Coil voltage

AC	50Hz	24, 32, 42, 48, 80, 100, 110, 220, 230, 240, 380, 400, 500, 550V
	60Hz	24, 48, 110, 110, 12, 200, 208, 220, 230, 240, 277, 380, 480, 600V
	50/60Hz	24, 48, 100, 110, 120, 200, 220, 230, 240, 380, 415, 440, 500, 550V
DC	DC	12, 20, 24, 48, 60, 80, 100, 110, 125, 200, 220, 250V

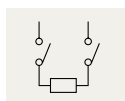

2-pole in series

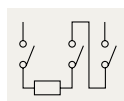

3-pole in series

Certification

- CE(IEC)
- UL508

Accessories

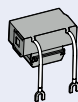

Surge unit, US
connecting to coil terminals
▶ 54 page

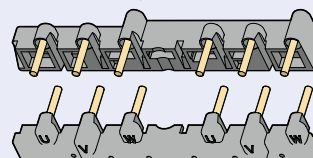

Wire kit, UW
for use with Interlock unit
▶ 50 page

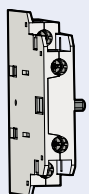

Auxiliary contact unit, UA1
side mount, 1NO+1NC
▶ 48 page

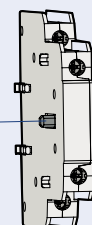
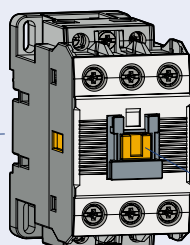

Interlock unit, UR
side mount
▶ 52 page

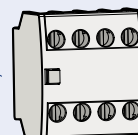

Auxiliary contact unit, AU-4
front mount, 4P
▶ 46 page



Auxiliary contact unit, AU-2
front mount, 2P
▶ 46 page

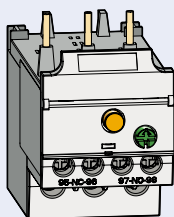

Overload relay, MT
directly mountable to MC type
contactor
▶ 60 page

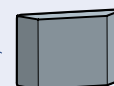

Safety cover, A7
▶ 56 page

Contactors (22AF)

Description

- 3-pole(NO) main contact
- Finger proof design
- DIN rail or screw mountable
- AC or DC control in different physical size
- Front/side mountable accessories available
- Direct mountable overload relay available Rating
- 1NO or 1NC Auxiliary contact built-in as standard.



MC-22b

Rating

Contactor type			MC-9b		MC-12b		MC-18b		MC-22b		
			kW	A	kW	A	kW	A	kW	A	
AC duty	AC3	200/240V	2.5	11	3.5	13	4.5	18	5.5	22	
		380/440V	4	9	5.5	12	7.5	18	11	22	
		500/550V	4	7	7.5	12	7.5	13	15	20	
		690V	4	5	7.5	9	7.5	9	15	18	
	AC4	200/240V	1.5	8	2.2	11	3.7	16	3.7	18	
		380/440V	2.2	6	4	9	4	11	5.5	13	
	AC1		-	25	-	25	-	32	-	40	
DC1 duty (L/R=1ms)	2-pole	24V	-	18	-	18	-	18	-	32	
		in series	48V	-	17	-	17	-	17	-	30
		110V	-	12	-	12	-	12	-	23	
	3-pole	24V	-	20	-	20	-	20	-	32	
		in series	48V	-	20	-	20	-	20	-	32
		110V	-	15	-	15	-	15	-	27	
DC 2,4 duty (L/R=15ms)	2-pole	24V	-	15	-	15	-	15	-	25	
		in series	48V	-	12	-	12	-	12	-	20
		110V	-	8	-	8	-	8	-	15	
	3-pole	24V	-	18	-	18	-	18	-	30	
		in series	48V	-	15	-	15	-	15	-	30
		110V	-	12	-	12	-	12	-	20	
Directly mountable Overload relay			MT-32								
Conductor size (solid, stranded)	AWG		16~10		16~8		14~8		14~8		
	(the max. number of conducts: 2)	mm ²	1.5~4		1.5~10		2.5~10		2.5~10		
Conductor type			65/75°C Cu-wire only								



Coil voltage

AC	50Hz	24, 32, 42, 48, 80, 100, 110, 220, 230, 240, 380, 400, 500, 550V
	60Hz	24, 48, 110, 110, 12, 200, 208, 220, 230, 240, 277, 380, 480, 600V
	50/60Hz	24, 48, 100, 110, 120, 200, 220, 230, 240, 380, 415, 440, 500, 550V
DC	DC	12, 20, 24, 48, 60, 80, 100, 110, 125, 200, 220, 250V

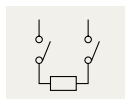

2-pole in series

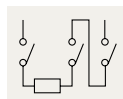

3-pole in series

Certification

- CE(IEC)
- UL508

Accessories



Surge unit, US
connecting to coil terminals
▶ 54 page

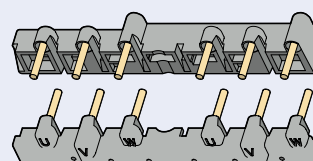

Wire kit, UW
for use with Interlock unit
▶ 52 page

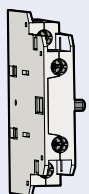

Auxiliary contact unit, UA1
side mount, 1NO+1NC
▶ 48 page

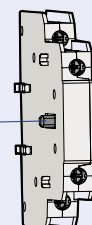
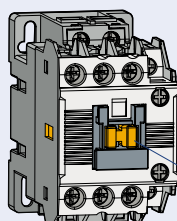

Interlock unit, UR
side mount
▶ 52 page

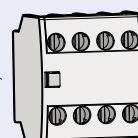

Auxiliary contact unit, AU-4
front mount, 4P
▶ 48 page



Auxiliary contact unit, AU-2
front mount, 2P
▶ 48 page

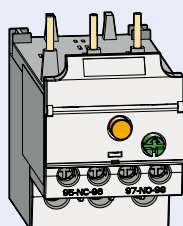

Overload relay, MT
directly mountable to MC type
contactor
▶ 61 page



Safety cover, A7
▶ 57 page

Contactors (40AF)

Description

- 3-pole(NO) main contact
- Finger proof design
- DIN rail or screw mountable
- AC or DC control in different physical size
- Front/side mountable accessories available
- Direct mountable overload relay available Rating



MC-40a

Rating

Contactor type			MC-32a		MC-40a		
			kW	A	kW	A	
AC duty	AC3	200/240V	7.5	32	11	40	
		380/440V	15	32	18.5	40	
		500/550V	18.5	28	22	32	
		690V	18.5	20	22	23	
	AC4	200/240V	4.5	20	5.5	25	
		380/440V	7.5	17	11	24	
	AC1		-	50	-	60	
DC1 (L/R=1ms)	2-pole	24V	-	32	-	55	
		in series	48V	-	30	-	55
		110V	-	25	-	40	
	3-pole	24V	-	32	-	55	
		in series	48V	-	32	-	55
		110V	-	27	-	45	
DC2,4 (L/R=15ms)	2-pole	24V	-	25	-	30	
		in series	48V	-	20	-	25
		110V	-	15	-	20	
	3-pole	24V	-	30	-	45	
		in series	48V	-	30	-	40
		110V	-	20	-	30	
Directly mountable Overload relay			MT-32				
Conductor size (solid, stranded)		AWG	12~8		10~6		
(the max. number of conducts: 2)		mm ²	2.5~10		4~16		
Conductor type			65/75°C Cu-wire only				



Coil voltage

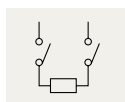

2-pole in series

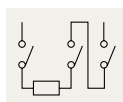

3-pole in series

AC	50Hz	24, 32, 42, 48, 80, 100, 110, 220, 230, 240, 380, 400, 500, 550V
	60Hz	24, 48, 110, 110, 12, 200, 208, 220, 230, 240, 277, 380, 480, 600V
	50/60Hz	24, 48, 100, 110, 120, 200, 220, 230, 240, 380, 415, 440, 500, 550V
DC	DC	12, 20, 24, 48, 60, 80, 100, 110, 125, 200, 220, 250V

Certification

- CE(IEC)
- UL508

Accessories

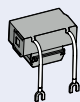

Surge unit, US
connecting to coil terminals
▶ 54 page

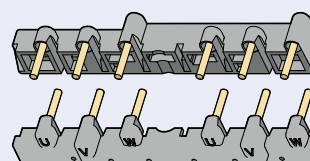

Wire kit, UW
for use with Interlock unit
▶ 52 page

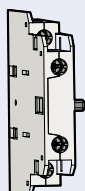

Auxiliary contact unit, UA1
side mount, 1NO+1NC
▶ 48 page

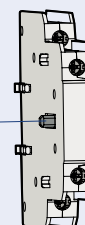
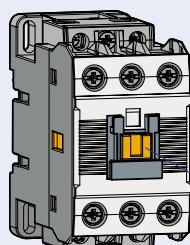

Interlock unit, UR
side mount
▶ 52 page

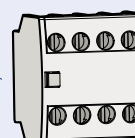

Auxiliary contact unit, AU-4
front mount, 4P
▶ 48 page



Auxiliary contact unit, AU-2
front mount, 2P
▶ 48 page

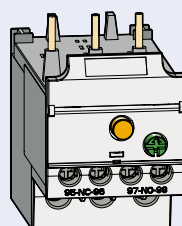

Overload relay, MT
directly mountable to MC type
contactor
▶ 61 page



Safety cover, A7
▶ 57 page

Contactors (65AF)

Description

- 3-pole(NO) main contact
- Finger proof design
- DIN rail or screw mountable
- AC or DC control in different physical size
- Front/side mountable accessories available
- Direct mountable overload relay available Rating



MC-65a

Rating

Contactor type			MC-50a		MC-65a		
			kW	A	kW	A	
AC duty	AC3	200/240V	15	55	18.5	65	
		380/440V	22	50	30	65	
		500/550V	30	43	33	60	
		690V	30	28	33	35	
	AC4	200/240V	7.5	35	11	50	
		380/440V	15	32	22	47	
	AC1		-	70	-	100	
DC1 duty (L/R=1ms)	2-pole	24V	-	70	-	90	
		in series	48V	-	70	-	90
			110V	-	50	-	75
	3-pole	24V	-	70	-	90	
		in series	48V	-	70	-	90
			110V	-	60	-	80
DC2, 4 duty (L/R=15ms)	2-pole	24V	-	45	-	55	
		in series	48V	-	40	-	45
			110V	-	25	-	38
	3-pole	24V	-	55	-	75	
		in series	48V	-	50	-	65
			110V	-	35	-	55
Directly mountable Overload relay			MT-63				
Conductor size (solid, stranded) (the max. number of conducts: 2)	AWG		10~4		8~3		
	mm ²		6~25		10~35		
Conductor type			65/75°C Cu-wire only				



Coil voltage

AC	50Hz	24, 32, 42, 48, 80, 100, 110, 220, 230, 240, 380, 400, 500, 550V
	60Hz	24, 48, 110, 110, 12, 200, 208, 220, 230, 240, 277, 380, 480, 600V
	50/60Hz	24, 48, 100, 110, 120, 200, 220, 230, 240, 380, 415, 440, 500, 550V
DC		12, 20, 24, 48, 60, 80, 100, 110, 125, 200, 220, 250V

Certification

- CE(IEC)
- UL508

Accessories

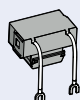

Surge unit, US
connecting to coil terminals
▶ 54 page

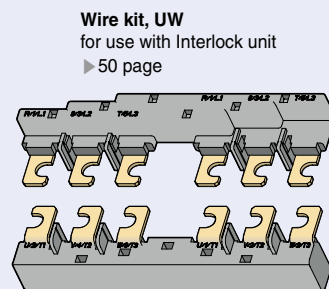

Wire kit, UW
for use with Interlock unit
▶ 50 page

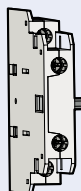

Auxiliary contact unit, UA1
side mount, 1NO+1NC
▶ 48 page

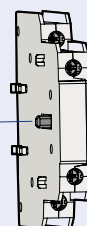
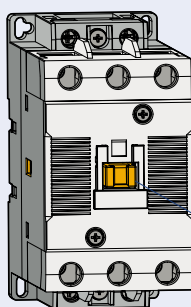

Interlock unit, UR
side mount
▶ 52 page

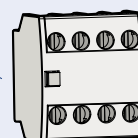

Auxiliary contact unit, AU-4
front mount, 4P
▶ 48 page



Auxiliary contact unit, AU-2
front mount, 2P
▶ 48 page

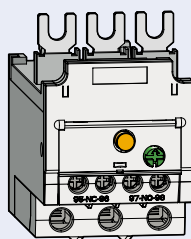

Overload relay, MT
directly mountable to MC type
contactor
▶ 61 page



Safety cover, A7
▶ 57 page

Contactors (100AF)

Description

- 3-pole(NO) main contact
- Finger proof design
- DIN rail or screw mountable
- AC or DC control in different physical size
- Front/side mountable accessories available
- Direct mountable overload relay available Rating



MC-100a

Rating

Contactor type			MC-75a		MC-85a		MC-100a		
			kW	A	kW	A	kW	A	
AC duty	AC3	200/240V	22	75	25	85	30	105	
		380/440V	37	75	45	85	55	105	
		500/550 V	37	64	45	75	55	85	
		690V	37	42	45	45	45	65	
	AC4	200/240V	13	55	15	65	19	80	
		380/440V	25	52	30	62	37	75	
	AC1		-	110	-	135	-	160	
DC1 duty (L/R=1ms)	2-pole	24V	-	90	-	100	-	100	
		in series	48V	-	90	-	100	-	100
		110V	-	75	-	80	-	80	
	3-pole	24V	-	90	-	100	-	100	
		in series	48V	-	90	-	100	-	100
		110V	-	80	-	85	-	85	
DC2, 4 duty (L/R=15ms)	2-pole	24V	-	55	-	60	-	60	
		in series	48V	-	45	-	50	-	50
		110V	-	38	-	40	-	40	
	3-pole	24V	-	75	-	80	-	80	
		in series	48V	-	65	-	70	-	70
		110V	-	55	-	60	-	60	
Directly mountable Overload relay			MT-95						
Conductor size (solid, stranded)	AWG		8~2		8~00		8~0		
	(the max. number of conducts: 2)	mm ²	10~35		10~50		10~70		
Conductor type			65/75°C Cu-wire only						



Coil voltage

AC	50Hz	24, 32, 42, 48, 80, 100, 110, 220, 230, 240, 380, 400, 500, 550V
	60Hz	24, 48, 110, 110, 12, 200, 208, 220, 230, 240, 277, 380, 480, 600V
	50/60Hz	24, 48, 100, 110, 120, 200, 220, 230, 240, 380, 415, 440, 500, 550V
DC	DC	12, 20, 24, 48, 60, 80, 100, 110, 125, 200, 220, 250V

Certification

- CE(IEC)
- UL508

Accessories

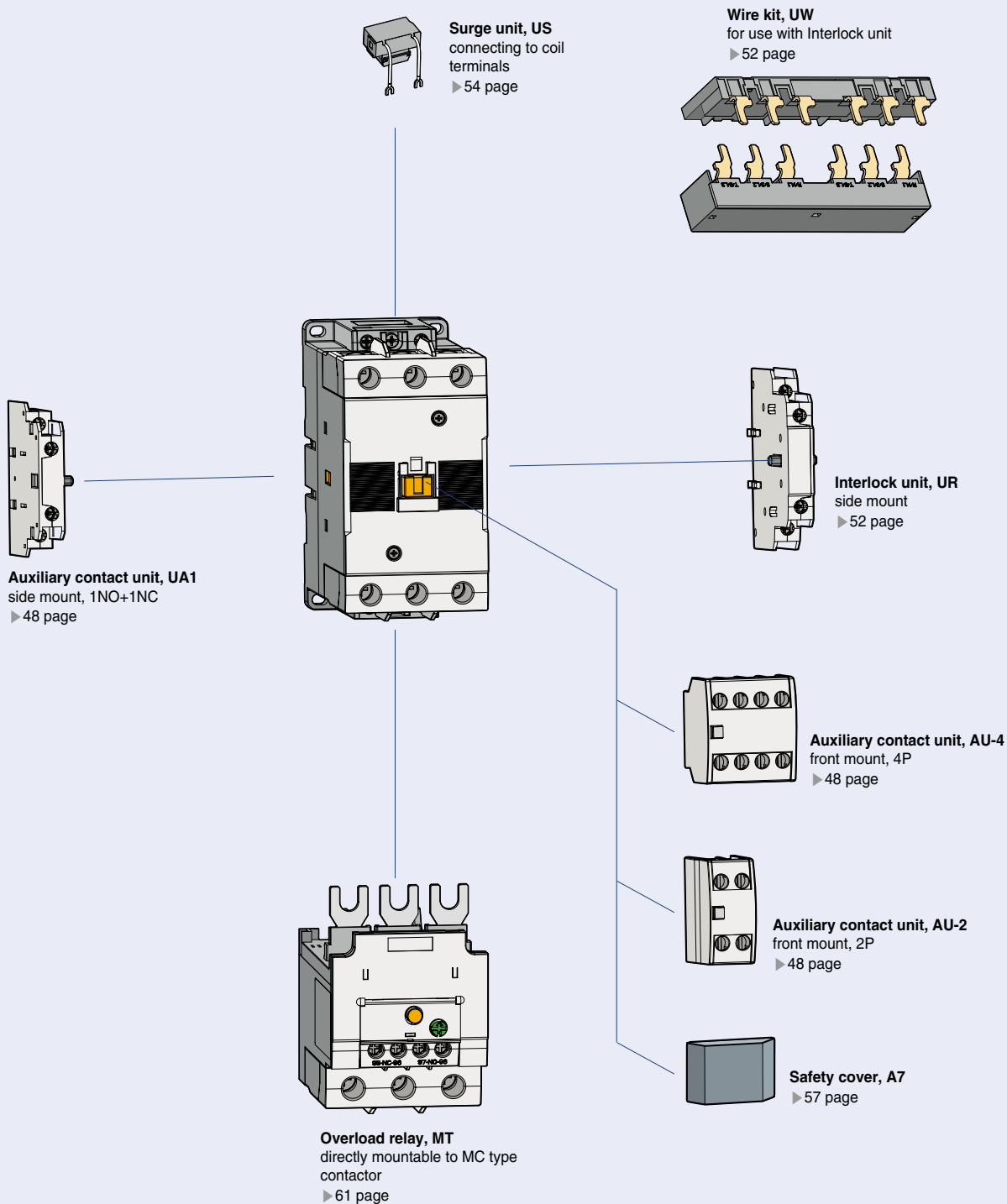

Contactors (150AF)

Description

- 3-pole(NO) main contact
- Finger proof design
- DIN rail or screw mountable
- AC or DC control in the same physical size
- Front/side mountable accessories available
- Direct mountable overload relay available

Rating



MC-150a

Contactor type			MC-130a		MC-150a		
			kW	A	kW	A	
AC duty	AC3	200/240V	37	130	45	150	
		380/440V	60	130	75	150	
		500/550V	60	90	70	100	
		690V	55	60	55	60	
	AC4	200/240V	22	93	30	120	
		380/440V	45	90	55	110	
	AC1		-	160	-	210	
DC1 duty (L/R=1ms)	2-pole	24V	-	120	-	150	
		in series	48V	-	100	-	120
		110V	-	80	-	100	
	3-pole	24V	-	120	-	150	
		in series	48V	-	120	-	150
		110V	-	100	-	150	
DC2, 4 duty (L/R=15ms)	2-pole	24V	-	120	-	150	
		in series	48V	-	60	-	100
		110V	-	40	-	80	
	3-pole	24V	-	120	-	150	
		in series	48V	-	90	-	130
		110V	-	80	-	120	
Directly mountable Overload relay			MT-150				
Conductor size (solid, stranded) (the max. number of conducts: 2)	AWG		3-00		3-00		
	mm ²		35-70		35-95		
Conductor type			65/75°C Cu-wire only				



Coil voltage

Control	Frequency	Voltages
AC	50/60Hz	24, 48, 110, 220, 300, 400, 500V
DC	DC	24, 48, 110, 220V

Certification

- CE(IEC)
- UL508

Accessories

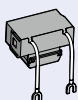

Surge unit, US
connecting to coil terminals
▶ 54 page

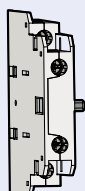

Auxiliary contact unit, UA1
side mount, 1NO+1NC
▶ 48 page

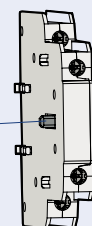
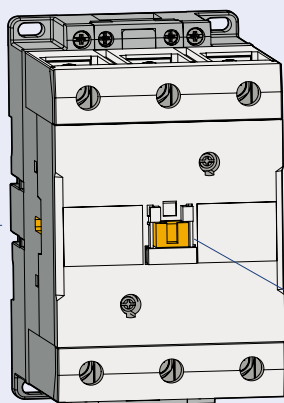

Interlock unit, UR
side mount
▶ 52 page

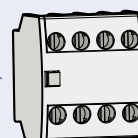

Auxiliary contact unit, AU-4
front mount, 4P
▶ 48 page



Auxiliary contact unit, AU-2
front mount, 2P
▶ 48 page

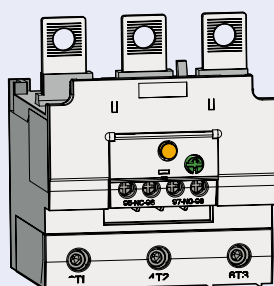

Overload relay, MT
directly mountable to MC type
contactor
▶ 62 page



Safety cover, A7
▶ 57 page

Contactors (225AF)

Description

- 3-pole main contact
- AC/DC common use coil built
- Wide coil operation voltage
- Screw mountable
- 2NO+2NC Auxiliary contacts built-in as standard
- Top/side mountable accessories available
- Direct mountable overload relays available



MC-225a

Rating

Contactor type			MC-185a		MC-225a		
			kW	A	kW	A	
AC duty	AC3	200/240V	55	185	75	225	
		380/440V	90	185	132	225	
		500/550V	110	180	132	200	
		690V	110	120	140	150	
	AC4	200/240V	37	150	45	180	
		380/440V	75	150	90	180	
	AC1		-	230	-	275	
DC1 duty (L/R=1ms)	2-pole	24V	-	180	-	220	
		in series	48V	-	180	-	180
		110V	-	150	-	150	
	3-pole	24V	-	180	-	220	
		in series	48V	-	180	-	220
		110V	-	180	-	220	
DC2, 4 duty (L/R=15ms)	2-pole	24V	-	180	-	220	
		in series	48V	-	150	-	150
		110V	-	120	-	120	
	3-pole	24V	-	180	-	220	
		in series	48V	-	180	-	220
		110V	-	150	-	150	
Directly mountable Overload relay			MT-225				
Conductor size (solid, stranded) (the max. number of conducts: 2)	AWG		1~410		110~300		
	mm ²		50~95		50~150		
Conductor type			75°C Cu stranded wire				



Coil voltage, AC/DC common

Nominal(ordering) voltage	AC 50/60Hz	DC
24V	24 - 25V	24V
48V	48 - 50V	48V
100/200V	100 - 240V	100 - 220V
300V	265 - 347V	-
400V	380 - 450V	-
500V	440 - 575V	-

Certification

- CE(IEC)
- UL508

Accessories



AD-100
Delayed opening device
▶ 51 page



Safety cover, A7
▶ 57 page



AP-220
Terminal cover
▶ 51 page



AI-225
Insulation barrier
▶ 51 page



AU-100, 100E
Auxiliary contact unit
side mount, 1NO+1NC
▶ 49 page



AR-180
Interlock unit
side mount
▶ 53 page

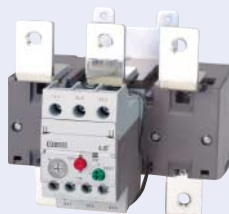

MT-225
Overload relay
directly mountable to the contactor
Current range 65-240A
▶ 63 page

Contactors (400AF)

Description

- 3-pole main contact
- AC/DC common use coil built
- Wide coil operation voltage
- Screw mountable
- 2NO+2NC Auxiliary contacts built-in as standard
- Top/side mountable accessories available
- Direct mountable overload relays available



Rating

Contactor type			MC-265a		MC-330a		MC-400a		
			kW	A	kW	A	kW	A	
AC duty	AC3	200/240V	80	265	90	330	125	400	
		380/440V	147	265	160	330	200	400	
		500/550V	147	225	160	280	225	350	
		690V	160	185	200	225	250	300	
	AC4	200/240V	50	200	55	220	75	300	
		380/440V	102	200	110	220	150	300	
	AC1		-	300	-	350	-	450	
DC1 duty (L/R=1ms)	2-pole	24V	-	220	-	300	-	400	
		in series	48V	-	180	-	240	-	240
		110V	-	150	-	200	-	200	
	3-pole	24V	-	220	-	300	-	400	
		in series	48V	-	220	-	300	-	400
		110V	-	220	-	300	-	400	
DC2, 4 duty (L/R=15ms)	2-pole	24V	-	220	-	300	-	400	
		in series	48V	-	150	-	200	-	200
		110V	-	120	-	150	-	150	
	3-pole	24V	-	220	-	300	-	400	
		in series	48V	-	220	-	280	-	280
		110V	-	150	-	200	-	200	
Directly mountable Overload relay			MT-400						
Conductor size (solid, stranded)	AWG		310~500		410~500		350~700		
	(the max. number of conducts: 2)	mm ²	95~240		95~240		185~370		
Conductor type			75°C Cu stranded wire						



Coil voltage, AC/DC common

Nominal(ordering) voltage	AC 50/60Hz	DC
100/200V	100 - 240V	100 - 220V
300V	265 - 347V	-
400V	380 - 450V	-
500V	440 - 575V	-

Certification

- CE(IEC)
- UL508

Accessories



AD-300
Delayed opening device
▶ 51 page

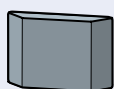

Safety cover, A7
▶ 57 page



AP-400
Terminal cover
▶ 51 page



AI-400
Insulation barrier
▶ 51 page



AU-100, 100E
Auxiliary contact unit
side mount, 1NO+1NC
▶ 49 page



AR-180
Interlock unit
side mount
▶ 53 page

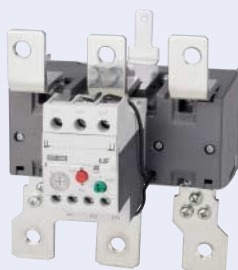

MT-400
Overload relay
directly mountable to the contactor
Current range 85–400A
▶ 63 page

Contactors (800AF)

Description

- 3-pole main contact
- AC/DC common use coil built
- Wide coil operation voltage
- Screw mountable
- 2NO+2NC Auxiliary contacts built-in as standard
- Top/side mountable accessories available
- Overload relays available



Rating

Contactor type			MC-500a		MC-630a		MC-800a		
			kW	A	kW	A	kW	A	
AC duty	AC3	200/240V	147	500	190	630	220	800	
		380/440V	265	500	330	630	440	800	
		500/550V	265	400	330	500	500	720	
		690V	300	380	400	420	500	630	
	AC4	200/240V	90	350	110	400	160	630	
		380/440V	176	350	200	400	300	630	
AC1		-	580	-	660	-	900		
DC1 duty (L/R=1ms)	2-pole	24V	-	400	-	630	-	800	
		in series	48V	-	240	-	630	-	800
		110V	-	200	-	630	-	630	
	3-pole	24V	-	400	-	630	-	800	
		in series	48V	-	400	-	630	-	800
		110V	-	400	-	630	-	800	
DC2, 4 duty (L/R=15ms)	2-pole	24V	-	400	-	630	-	800	
		in series	48V	-	200	-	630	-	630
		110V	-	150	-	630	-	630	
	3-pole	24V	-	400	-	630	-	800	
		in series	48V	-	280	-	630	-	630
		110V	-	200	-	630	-	630	
Directly mountable Overload relay			MT-800						
Conductor size (solid, stranded)	AWG		350~800		600~2000		1700~Busbar		
	(the max. number of conducts: 2)	mm ²	185~480		-		-		
Conductor type			75°C Cu stranded wire						



Coil voltage, AC/DC common

Nominal(ordering) voltage	AC 50/60Hz	DC
100V	100 - 127V	100 - 110V
200V	200 - 240V	200 - 220V
300V	265 - 347V	-
400V	380 - 450V	-
500V	440 - 575V	-

Certification

- CE(IEC)
- UL508

Accessories



AD-600
Delayed opening device
▶ 51 page

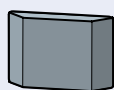

Safety cover, A7
▶ 57 page



AP-600
Terminal cover
▶ 51 page



AI-600
Insulation barrier
▶ 51 page



AU-100, 100E
Auxiliary contact unit
side mount, 1NO+1NC
▶ 49 page



AR-600
Interlock unit
side mount
▶ 53 page



MT-800
Overload relay
directly mountable to the contactor
Current range 200~800A
▶ 63 page

Motor starters

Description

- Opened direct motor starter
- 3-pole(NO) main contact
- Finger proof design
- DIN rail or screw mountable
- AC or DC control contactor selectable
- Front/side mountable accessories available
- Overload relay is directly mounted to the contactor



Rating

Starter type	18AF				22AF			
	MS-6a	MS-9a	MS-12a	MS-18a	MS-9b	MS-12b	MS-18b	MS-22b
Number of poles	3				3			
Rated operational voltage (Ue)	Up to 690V				Up to 690V			
Degree of pollution (IEC60529)	IP20				IP20			
Rated operational current Ie ($\theta \leq 40^\circ\text{C}$)								
AC-1 Ue max 690V A	25	25	25	32	25	25	32	40
AC-3 200/240V A	9	11	13	18	11	13	18	22
380/400V A	7	9	12	18	9	12	18	22
415V A	7	9	12	18	9	12	18	22
440V A	7	9	12	18	9	12	18	22
500V A	6	7	12	13	7	12	13	20
690V A	4	5	9	9	6	9	9	18
Rated operational power ($\theta \leq 40^\circ\text{C}$)								
AC-3 200/240V kW	2.2	2.5	3.5	4.5	2.5	3.5	4.5	5.5
380/400V kW	3	4	5.5	7.5	4	5.5	7.5	11
415V kW	3	4	5.5	7.5	4	5.5	7.5	11
440V kW	3	4	5.5	7.5	4	5.5	7.5	11
500V kW	3	4	7.5	7.5	4	7.5	7.5	15
690V kW	3	4	7.5	7.5	4	7.5	7.5	15
According to IEC60947-4-1								
Rated making capacity AC-3	70	90	120	180	90	120	180	220
Rated breaking capacity AC-3	56	72	96	144	72	96	144	176
Electrical life for Ie/AC-3 Max in millions of operating cycles	2.5	2.5	2.5	2.5	2.5	2.5	2.5	2.5
Maximum operating rate in operating cycles per hour	1800	1800	1800	1800	1800	1800	1800	1800

Devices usable in the starter combination

Contactors		18AF				22AF			
		MC-6a	MC-9a	MC-12a	MC-18a	MC-9b	MC-12b	MC-18b	MC-22b
with AC or DC control coil									
with coil in common use for AC and DC		-	-	-	-	-	-	-	-
Thermal Overload Relays									
Class 10A Differential type		MT-12/3K				MT-32/3K			
Non-differential type		MT-12/3H				MT-32/3H			
Non-differential type(2-heater)		MT-12/2H				MT-32/2H			
Class 20 Differential type		MT-12/3D				MT-32/3D			
Setting range	A	0.1~18A				0.1~40A			



40AF	
MS-32a	MS-40a
3	
Up to 690V	
IP20	
50	60
32	40
32	40
32	40
32	40
28	32
20	23
7.5	11
15	18.5
15	18.5
15	18.5
18.5	22
18.5	22
320	400
256	320
2	2
1800	1800

65AF	
MS-50a	MS-65a
3	
Up to 690V	
IP20	
70	100
55	65
50	65
50	65
50	65
43	60
28	35
15	18.5
22	30
22	30
22	30
30	33
30	33
500	650
400	520
2	2
1800	1800

100AF		
MS-75a	MS-85a	MS-100a
3		
Up to 690V		
IP20		
110	135	160
75	85	105
75	85	105
75	85	105
75	85	105
64	75	85
42	45	65
22	25	30
37	45	55
37	45	55
37	45	55
37	45	55
37	45	45
750	850	1050
600	650	840
2	2	2
1800	1800	1800

MC-32a	MC-40a
-	-
MT-32/3K	
MT-32/3H	
MT-32/2H	
MT-32/3D	
0.1~40A	

MC-50a	MC-65a
-	-
MT-63/3K	
MT-63/3H	
MT-63/2H	
MT-63/3D	
4~65A	

MC-75a	MC-85a	MC-100a
-	-	-
MT-95/3K		
MT-95/3H		
MT-95/2H		
MT-95/3D		
7~100A		

Motor starters

Description

- Opened direct motor starter
- 3-pole(NO) main contacts
- Screw mountable
- AC/DC common use control contactor used (from 225AF)
- Additional accessories available
- Overload relay is directly mounted to the contactor



Rating

Starter type	150AF		225AF	
	MS-130a	MS-150a	MS-185a	MS-225a
Number of poles	3		3	
Rated operational voltage (Ue)	Up to 690V		Up to 690V	
Degree of pollution (IEC60529)	IP20		IP20	
Rated operational current Ie ($\theta \leq 40^\circ\text{C}$)				
AC-1 Ue max 690V A	160	210	230	275
AC-3 200/240V A	130	150	185	225
380/400V A	130	150	185	225
415V A	130	150	185	225
440V A	130	150	185	225
500V A	90	100	180	200
690V A	60	60	120	150
Rated operational power ($\theta \leq 40^\circ\text{C}$)				
AC-3 200/240V kW	37	45	55	75
380/400V kW	60	75	90	132
415V kW	60	75	90	132
440V kW	60	75	90	132
500V kW	60	70	110	132
690V kW	55	55	110	140
According to IEC60947-4-1				
Rated making capacity AC-3	1200	1500	1850	2250
Rated breaking capacity AC-3	960	1200	1480	1800
Electrical life for Ie/AC-3 Max in millions of operating cycles	1	1	1	1
Maximum operating rate in operating cycles per hour	1200	1200	1200	1200

Devices usable in the starter combination

Contactors		150AF		225AF	
		MC-130a	MC-150a	-	-
with AC or DC control coil					
with coil in common use for AC and DC		-	-	MC-185a	MC-225a
Thermal Overload Relays		150AF		225AF	
Class 10A Differential type		MT-150/3K		MT-225/3K	
Non-differential type		MT-150/3H		MT-225/3H	
Non-differential type(2-heater)		MT-150/2H		MT-225/2H	
Class 20 Differential type		MT-150/3D		MT-225/3D	
Setting range	A	34-150A		65-240A	



400AF		
MS-265a	MS-330a	MS-400a
3		
Up to 690V		
IP20		
300	350	450
265	330	400
265	330	400
265	330	400
265	330	400
225	280	350
185	225	300
80	90	125
147	160	200
147	160	200
147	160	200
147	160	225
160	200	250
2650	3300	4000
2120	2640	3200
1	1	1
1200	1200	1200

800AF		
MS-500a	MS-630a	MS-800a
3		
Up to 690V		
IP20		
580	660	900
500	630	800
500	630	800
500	630	800
500	630	800
400	500	720
380	420	630
147	190	220
265	330	440
265	330	440
265	330	440
265	330	500
300	400	500
5000	6300	8000
4000	5040	6400
0.5	0.5	0.5
1200	1200	1200

-	-	-
MC-265a	MC-330a	MC-400a
MT-400/3K		
MT-400/3H		
MT-400/2H		
MT-400/3D		
85~400A		

-	-	-
MC-500a	MC-630a	MC-800a
MT-800/3K		
MT-800/3H		
MT-800/2H		
MT-800/3D		
200~800A		

Reversing contactors

Description

- Two AC or DC control contactors are interlocked mechanically and electrically
- 3-pole(NO) main contact in each contactor
- Finger proof design
- DIN rail or screw mountable
- Front/side mountable accessories available
- Overload relay can be directly mounted to the contactor if necessary

Circuit diagram

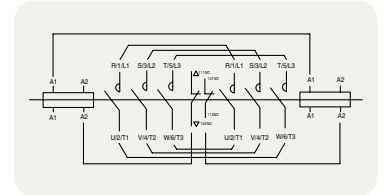

Rating

Type	AC-3 duty						Current (AC3)	Weight (AC control)
	200 ~ 240V	380 ~ 400V	415V	440V	500V	690V	440V	
	kW	kW	kW	kW	kW	kW	A	
MC-6a/R	2.2	3	3	3	3	3	7	0.63kg
MC-9a/R	2.5	4	4	4	4	4	9	0.63kg
MC-12a/R	3.5	5.5	5.5	5.5	7.5	7.5	12	0.63kg
MC-18a/R	4.5	7.5	7.5	7.5	7.5	7.5	18	0.63kg
MC-9b/R	2.5	4	4	4	4	4	9	0.75kg
MC-12b/R	3.5	5.5	5.5	5.5	7.5	7.5	12	0.75kg
MC-18b/R	4.5	7.5	7.5	7.5	7.5	7.5	18	0.75kg
MC-22b/R	5.5	11	11	11	15	15	25	0.75kg
MC-32a/R	11	18.5	18.5	18.5	22	22	32	0.95kg
MC-40a/R	11	18.5	18.5	18.5	22	22	40	0.95kg
MC-50a/R	15	22	22	22	30	30	50	1.7kg
MC-65a/R	18.5	30	30	30	33	33	65	1.7kg
MC-75a/R	22	37	37	37	37	37	75	3.3kg
MC-85a/R	25	45	45	45	45	45	85	3.3kg
MC-100a/R	30	55	55	55	55	45	100	3.3kg



MC-40a/R



MC-65a/R



MC-100a/R

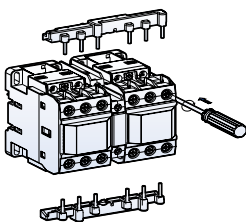

Coil voltage

AC	50Hz	24, 32, 42, 48, 80, 100, 110, 220, 230, 240, 380, 400, 500, 550V
	60Hz	24, 48, 110, 110, 12, 200, 208, 220, 230, 240, 277, 380, 480, 600V
	50/60Hz	24, 48, 100, 110, 120, 200, 220, 230, 240, 380, 415, 440, 500, 550V
DC	DC	12, 20, 24, 48, 60, 80, 100, 110, 125, 200, 220, 250V

Certification

- CE(IEC)
- UL508

Description

- 3-pole main contact
- Mechanically interlocked
- AC/DC common use coil built (from MC-185a/R)
- Wide coil operation voltage
- Screw mountable
- 2NO+2NC Auxiliary contacts built-in as standard
- Top/side mountable accessories available



Rating

Type	AC-3 duty						Current (AC3)	Weight (AC control)
	200 ~ 240V	380 ~ 400V	415V	440V	500 ~ 550V	690V	440V	
	kW	kW	kW	kW	kW	kW	A	
MC-130a/R	37	60	60	60	60	55	120	4.3kg
MC-150a/R	45	75	75	75	75	55	150	4.3kg
MC-185/R	55	90	90	90	110	110	185	13kg
MC-225a/R	75	132	132	132	132	140	225	13kg
MC-265a/R	80	147	147	147	147	160	265	21.4kg
MC-330a/R	90	160	160	160	160	200	330	21.4kg
MC-400a/R	125	200	200	200	225	250	400	21.4kg
MC-500a/R	147	265	265	265	265	300	500	60kg
MC-630a/R	190	330	330	330	330	400	630	60kg
MC-800a/R	220	440	440	440	440	500	800	60kg



Coil voltage

For MC130/R and MC-150a/R

AC	50/60Hz	24, 48, 110, 220, 300, 400, 500V
DC	DC	24, 48, 110, 220V

For MC-185a/R and up

- 24, 48, 100/200, 300, 400, 500V for types MC-185a/R, 225/R
- 100/200, 300, 400, 500V for types MC-265a/R, 330/R, 400/R
- 100, 200, 300, 400, 500V for types MC-500a/R, 600/R, 800/R

Nominal(ordering) voltage	AC 50/60Hz	DC
24V	24 - 25V	24V
48V	48 - 50V	48V
100V	100 - 127V	100 - 110V
200V	200 - 240V	200 - 220V
100/200V	100 - 240V	100 - 220V
300V	265 - 347V	-
400V	380 - 450V	-
500V	440 - 575V	-

Capacitive contactors

Description

Capacitor unit(Pre-loading resistor) is connected to the terminals of the contactor to reduce the high inrush current exceeding $20 \times I_n$.

- AC or DC control coil on selection
- 3-pole(NO) main contact
- Finger proof design
- DIN rail or screw mountable

Rating

Type	Maximum operating power (kvar)			Rated current (A)	Capacitor unit type
	220 ~ 240V	400 ~ 440V	500 ~ 550V		
MC-9a/9b(D)	5	9.7	14	14	AC-9
MC-12a/12b(D)	6.7	12.5	18	18	AC-9
MC-18a/18b(D)	8.5	16.7	24	24	AC-9
MC-22b(D)	10	18	26	26	AC-9
MC-32a(D)	15	25	36	36	AC-9
MC-40a(D)	20	33.3	48	48	AC-9
MC-50a(D)	20	40	58	58	AC-50
MC-65a(D)	25	45.7	66	66	AC-50
MC-75a(D)	29.7	54	78	78	AC-50
MC-85a(D)	35	60	92	92	AC-50
MC-100a(D)	37	62	94	94	AC-50

Note) - When the switch is closed condenser must be discharged before recharged. (Maximum residual voltage at terminals $\leq 50V$)
 - To prevent short current, gG type fuse must be 1.5-2 times than rated current.



Coil voltage

50Hz	24, 32, 42, 48, 80, 100, 110, 220, 230, 240, 380, 400, 500, 550V
AC	60Hz 24, 48, 110, 110, 12, 200, 208, 220, 230, 240, 277, 380, 480, 600V
	50/60Hz 24, 48, 100, 110, 120, 200, 220, 230, 240, 380, 415, 440, 500, 550V
DC	DC 12, 20, 24, 48, 60, 80, 100, 110, 125, 200, 220, 250V

These capacitive contactors are suitable for switching single-step or multiple-step condenser bank.

It is standardized by IEC-60947-4941, UL and CSA.

Features of capacitor unit(Pre-loading resistor)

- Damping resistor that can limit the inrush current upto $60 \times I_n$ is connected to the mechanism that closed earlier than the main contact of the contactor
- No heat loss by the serial resistor
- Eliminate the switching surge
- Improving the performance of the capacitor system

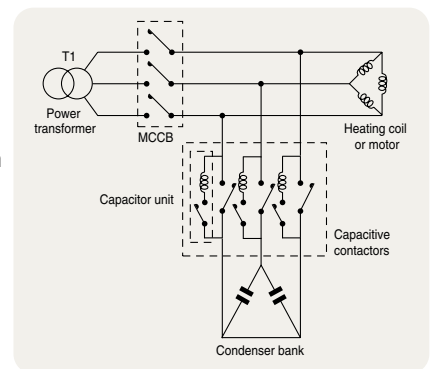

Example

Metasol Accessories

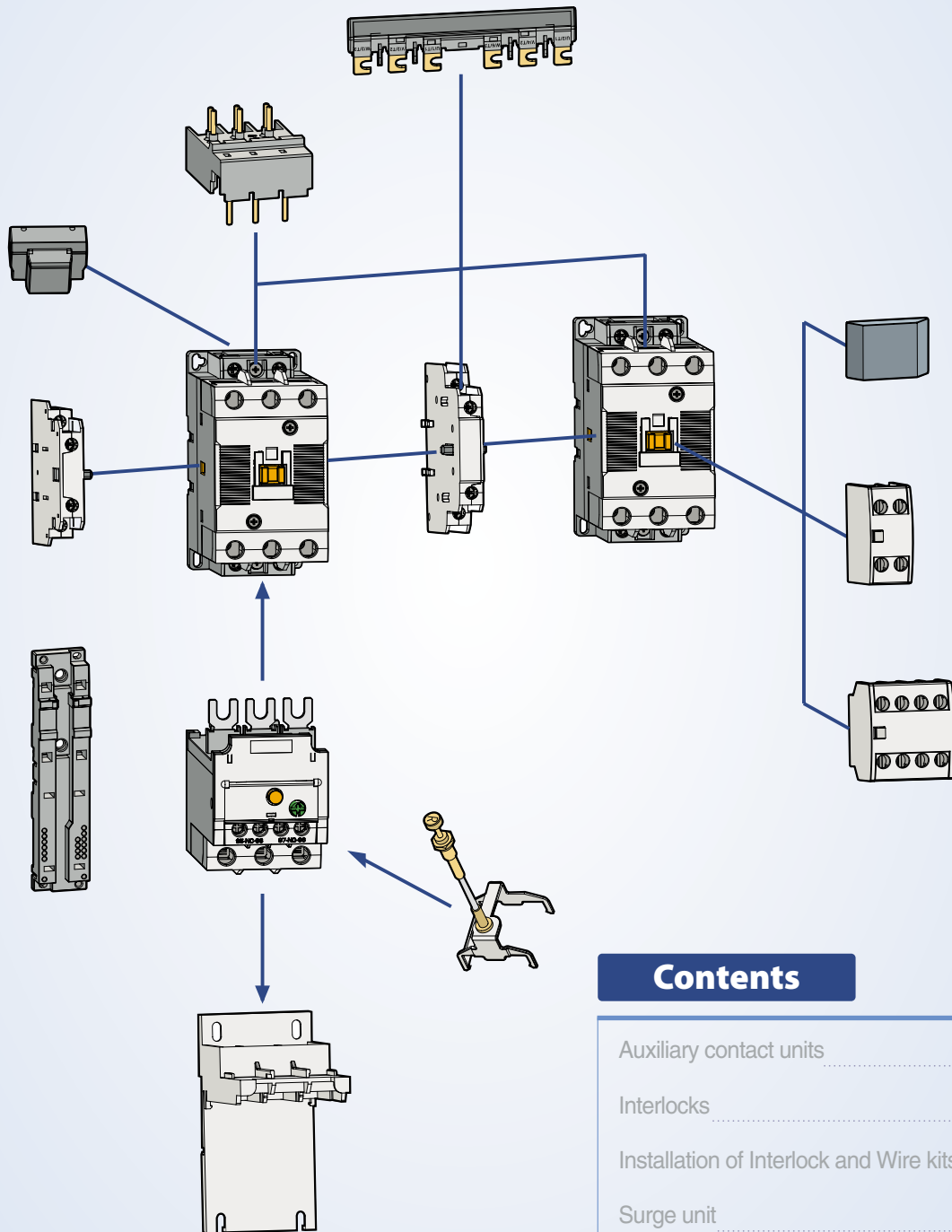

Contents

Auxiliary contact units	48
Interlocks	52
Installation of Interlock and Wire kits	53
Surge unit	54
Capacitor unit	55
Replacement coils	56
Safety cover (Option)	57

Auxiliary contact units

- 2 and 4 pole
- Side or front mountable
- Common use for Metasol contactors from MC-6 to MC-150a

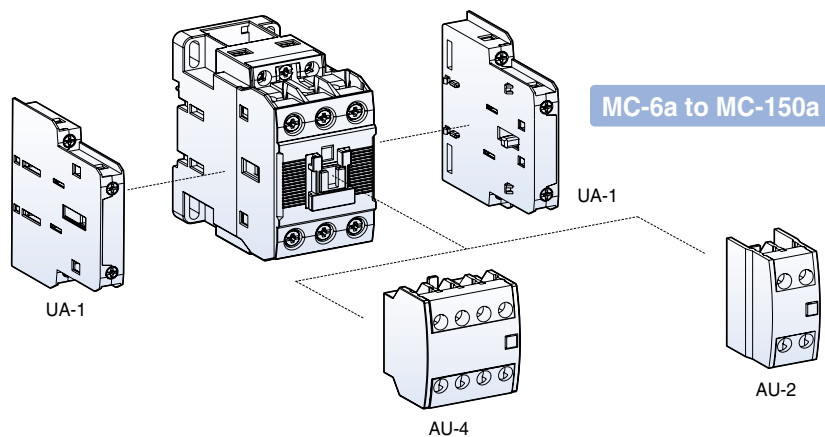

Selection

Type	Appearance	Pole	Composition		Contact arrangement	Mount	Weight
			NO	NC			
UA-1		2	1	1	<p>13(43) 21(31) 14(44) 22(32)</p>	Side	53g
AU-2		2	2 1 -	- 1 2	<p>53 63 51 63 51 61 54 64 52 64 52 62</p>	Front	28g
AU-4		4	4 3 2 1 -	- 1 2 3 4	<p>53 63 73 83 53 61 73 83 53 61 71 83 54 64 74 84 54 62 74 84 54 62 72 84</p>	Front	50g

Maximum combination of contact units

For contactors with AC coils	For contactors with DC coils
AU-4(on front)+UA-1 × 4EA (2EA on both sides)	AU-4(on front)+UA-1 × 2EA (1EA on both sides)
AU-2(on front)+UA-1 × 4EA (2EA on both sides)	AU-2(on front)+UA-1 × 2EA (1EA on both sides)

- 2 pole
- Side mountable
- MC MC Common use for Metasol contactors from MC-185a to MC-800a

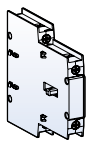
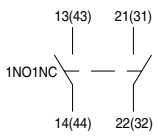
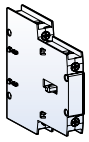
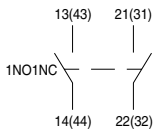

Selection

Type	Appearance	Pole	Composition		Contact arrangement	Mount	Weight
			NO	NC			
AU-100		2	1	1		Side	53g
AU-100E		2	1	1		Side	53g

Auxiliary contact units

Rating

Type		UA-1	AU-2, 4	AU-100	AU-100E	
Rated operation voltage (Ue)		600V	600V	600V	60V	
Rated insulation voltage (Ui)		600V	600V	600V	600V	
Rated impulse withstand voltage (Uimp)		6kV	6kV	6kV	6kV	
Rated frequency		50/60Hz	50/60Hz	50/60Hz	50/60Hz	
Contact sensibility						
	Voltage	DC 17V	DC 24V	DC 24V	DC 7V	
	Current	DC 5mA	DC 10mA	DC 10mA	DC 5mA	
Rated thermal current (Ith, AC12 duty)		10A	16A	16A	1A	
Rated operation current						
AC15 duty (A600)	120V	6A	6A	6A	AC/DC 24V 0.1A AC/DC 50V 0.01A	
	240V	3A	3A	3A		
	380V	1.9A	1.9A	1.9A		
	480V	1.5A	1.5A	1.5A		
	500V	1.4A	1.4A	1.4A		
	600V	1.2A	1.2A	1.2A		
	DC13 duty (P600)	125V	1.1A	1.1A		1.1A
		250V	0.55A	0.55A		0.55A
		400V	0.31A	0.31A		0.31A
		500V	0.27A	0.27A		0.27A
600V		0.2A	0.2A	0.2A		
Electrical lifetime (mil. operations)						
AC15 duty	220V	0.5	0.5	0.5	AC/DC 24V 1A AC/DC 50V 1A	
	440V	0.5	0.5	0.5		
DC13 duty	220V	0.5	0.5	0.5		
	440V	0.5	0.5	0.5		
Maximum operating cycles per hour		1800	1800	1800	1200	
Conductor size (Solid, stranded)	AWG	18~10	18~10	18~10	18~10	
	(the max. number of conducts: 2) mm ²	1~2.5	1~2.5	1~2.5	1~2.5	

Installation

UA-1

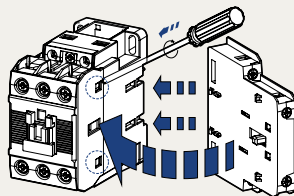

To install side mounting unit remove the indicated part in the circle in the fig. first. And then fit each part as shown. To separate push forward and pull.

AU-2, 4

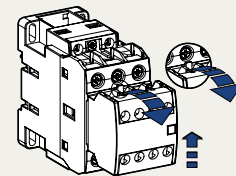

To install front mounting unit fit it on the upper part of the front of the contactor and push it down. To separate pull the lever of the unit and push the unit upward.

Delayed opening devices



Delayed opening device prevents the inadvertent opening of a contactor in the event of a wide voltage drop or brief supply voltage interruptions of control power for 1 to 4 seconds.

Applying contactors	Type	Control voltage	
		Delayed opening device coil	Contactor device coil
MC-185a, 225a (225AF)	AD-100	AC100~110V	DC100/110V
MC-265a, 330a, 400a (400AF)	AD-300	AC200~220V	DC200/220V
MC-500a, 630a, 800a (800AF)	AD-600		

Terminal cover units for contactors



Applying contactors	Type	Remarks
MC-185a, 225a (225AF)	AP-220	
MC-265a, 330a, 400a (400AF)	AP-400	2 pcs included
MC-500a, 630a, 800a (800AF)	AP-800	

Insulation barrier units



Applying contactors	Type	Remarks
MC-185a, 225a (225AF)	AI-180	
MC-265a, 330a, 400a (400AF)	AI-180	4 pcs required per contactor
MC-500a, 630a, 800a (800AF)	AI-600	

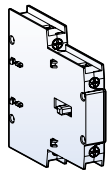

Interlock unit

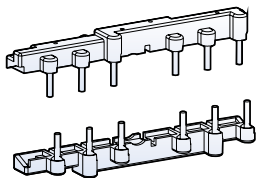

Wire kit

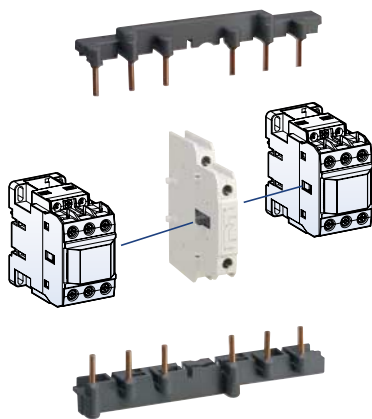

Interlocks

Component parts for assembling by customer

Interlock unit, UR-02

UR-02 is a mechanical interlock unit and provides 2NC contacts for use in electrical interlocking

Wire kit, UW

UW is used for making reversing circuit between two contactors.

Contactor	Wire kit		Interlock unit	
	Type	Weight	Type	Weight
MC-6a~18a	UW-18	0.05kg	UR-02	0.06kg
MC-9b~22b	UW-22	0.04kg		
MC-32a~40a	UW-32	0.05kg		
MC-50a, 65a	UW-63	0.12kg		
MC-75a~100a	UW-95	0.33kg		

Rating of the contacts in the interlocks

Rated operation voltage	600V	
Rated insulation voltage	600V	
Rated frequency	50/60Hz	
Rated thermal current	10A	
Rated operation current		
AC15 duty	120V	6A
(A600)	240V	3A
	380V	1.9A
	480V	1.5A
	500V	1.4A
	600V	1.2A
DC13 duty	125V	0.55A
(Q300)	250V	0.27A

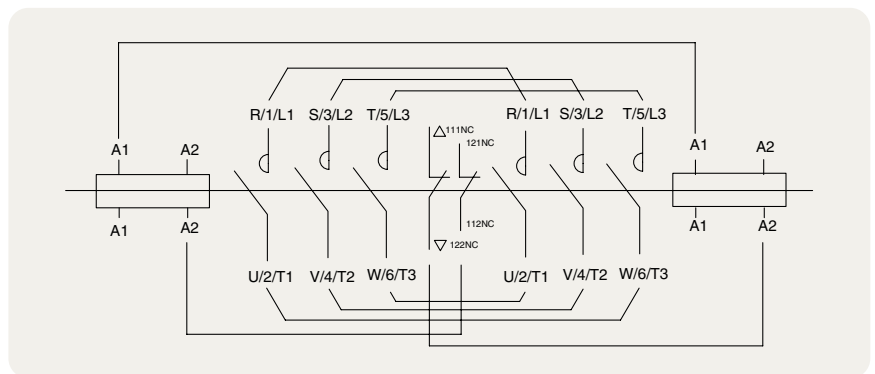

Typical circuit diagram for reversing contactor



AR-180

Interlock unit, AR-180 and AR-600

AR-180 and AR-600 are mechanical interlock units in which electrical contacts for use in electrical interlocking are not included. Please use the auxiliary contacts on the sides of the contactors for that purpose.



AR-600

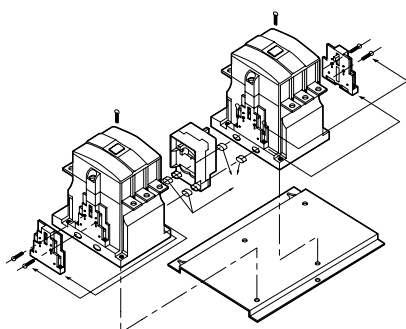

Contactor	Interlock unit	
	Type	Weight
MC-180a MC-225a MC-265a MC-330a MC-400a	AR-180	0.09kg
MC-500a MC-630a MC-800a	AR-600	15.2kg

Installation of Interlock and Wire kits

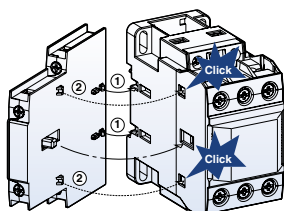

Install the interlock unit on the side of a contactor first. Fit each part as indicated in the fig.

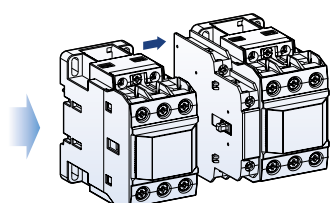

And then install the other contactor on the other side of the interlock unit as shown.

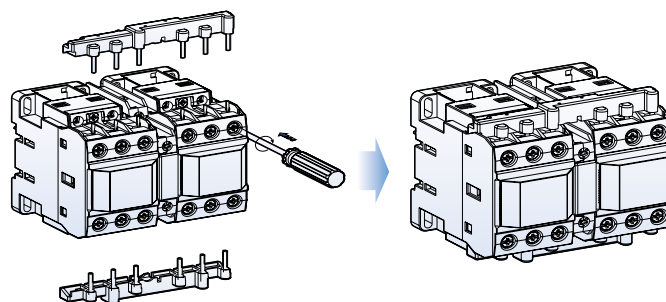

After installing interlock unit wiring kit can be assembled.

Wiring kit contains two molded wires - one for line side and the other for load side.

Surge unit

It absorbs the surge arisen out of the coil of the contactor.
It can be installed simply to the contactor.

- Rated operation voltage (Ue): AC 24 ~ 440V
DC 24 ~ 125V
- Rated insulation voltage (Ui): 1000V
- Rated impulse withstand voltage (Uimp): 8kV
- Degree of protection: IP20

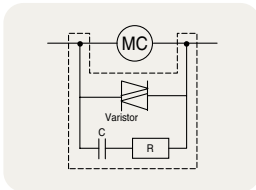

US-1-6

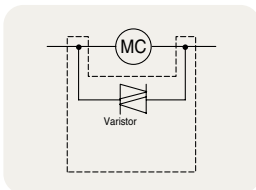

US-11-14

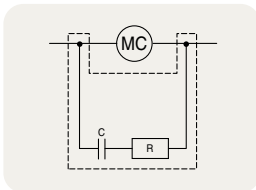

US-22

Surge unit		Rated voltage		Internal elements spec.			Weight
Type	Composition			V	R	C	
US-1	Varistor+RC	AC	24~48V	120V	100 Ω	0.1 μF	29g
US-2	Varistor+RC		100~125V	270V	100 Ω	0.1 μF	
US-3	Varistor+RC		200~240V	470V	100 Ω	0.1 μF	
US-4	Varistor+RC	DC	24~48V	120V	100 Ω	0.47 μF	
US-5	Varistor+RC		100~125V	270V	100 Ω	0.47 μF	
US-6	Varistor+RC		200~220V	470V	100 Ω	0.47 μF	
US-11	Varistor	AC/DC common	24~48V	120V	-	-	
US-12	Varistor		100~125V	270V	-	-	
US-13	Varistor		200~240V	470V	-	-	
US-14	Varistor		380~440V	1000V	-	-	
US-22	RC	AC	100~125V	-	56 Ω	1 μF	

Installation

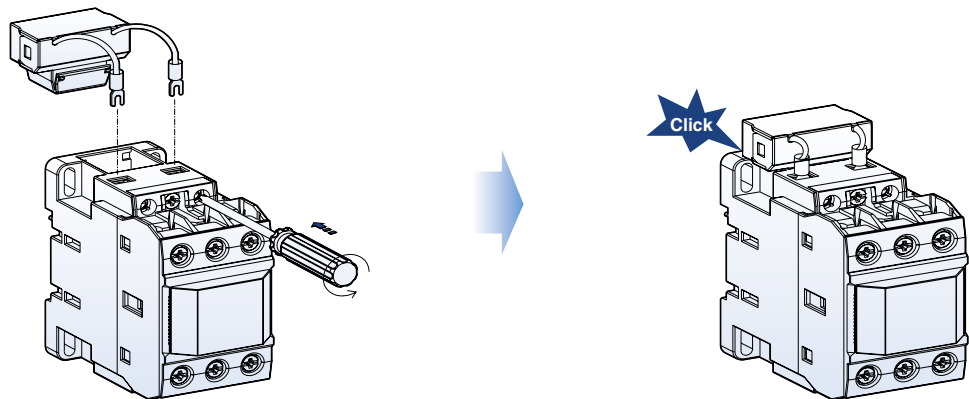

Connect the lead wires to the coil terminals of the contactor first.
And then insert the body into the space of the contactor as shown above.

Capacitor unit

Capacitor unit is connected to the terminals of the contactor to reduce the high inrush current.



Type	Contactor	Maximum operating power (kvar)			Rated current (A)
		220 ~ 240V	400 ~ 440V	500 ~ 550V	
AC-9	MC-9a/9b(D)	5	9.7	14	14
	MC-12a/12b(D)	6.7	12.5	18	18
	MC-18a/18b(D)	8.5	16.7	24	24
	MC-22b(D)	10	18	26	26
	MC-32a(D)	15	25	36	36
	MC-40a(D)	20	33.3	48	48
AC-50	MC-50a(D)	20	40	58	58
	MC-65a(D)	25	45.7	66	66
	MC-75a(D)	29.7	54	78	78
	MC-85a(D)	35	60	92	92
	MC-100a(D)	37	62	94	94

Note) - When the switch is closed condenser must be discharged before recharged. (Maximum residual voltage at terminals $\leq 50V$)
 - To prevent short current, gG type fuse must be 1.5~2 times than rated current.

Features of capacitor unit (Pre-loading resistor)

- Damping resistor that can limit the inrush current upto $60 \times I_n$ is connected to the mechanism that closed earlier than the main contact of the contactor
- No heat loss by the serial resistor
- Eliminate the switching surge
- Improving the performance of the capacitor system

Operation sequence

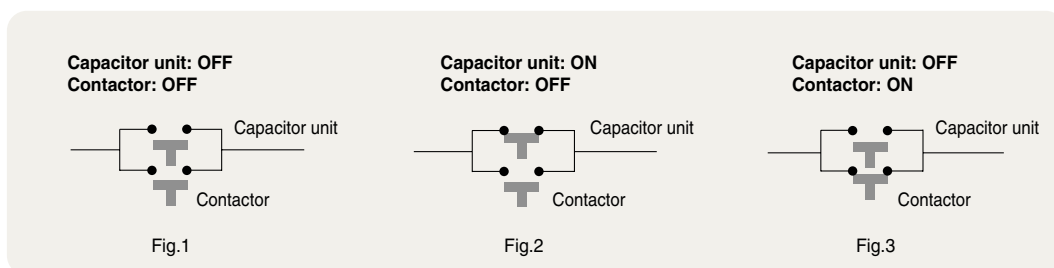

Note) Closing sequence: Fig.1 => Fig.2 => Fig.3
 Opening sequence: Fig.3 => Fig.1

Replacement coils

To replace the existing coil to change voltage or repair.

Contactor	Coil voltage							
	AC coil						DC coil	
	AC 60Hz (V)		AC 50Hz (V)		AC 50/60Hz (V)		DC (V)	
MC-6a MC-9a MC-12a MC-18a	24	230	24	230	24	240	12	110
	48	240	36	240	48	380	20	125
	100	277	42	380	100	415	24	200
	110	380	48	400	110	440	48	220
	120	440	80	415	120	500	60	250
	200	480	100	440	200	550	80	
	208	600	110	500	220		100	
	220		220	550	230			
MC-9b MC-12b MC-18b MC-22b	24	230	24	230	24	240	12	110
	48	240	36	240	48	380	20	125
	100	277	42	380	100	415	24	200
	110	380	48	400	110	440	48	220
	120	440	80	415	120	500	60	250
	200	480	100	440	200	550	80	
	208	600	110	500	220		100	
	220		220	550	230			
MC-32a MC-40a	24	230	24	230	24	240	12	110
	48	240	36	240	48	380	20	125
	100	277	42	380	100	415	24	200
	110	380	48	400	110	440	48	220
	120	440	80	415	120	500	60	250
	200	480	100	440	200	550	80	
	208	600	110	500	220		100	
	220		220	550	230			
MC-50a MC-65a	24	230	24	230	24	240	12	110
	48	240	36	240	48	380	20	125
	100	277	42	380	100	415	24	200
	110	380	48	400	110	440	48	220
	120	440	80	415	120	500	60	250
	200	480	100	440	200	550	80	
	208	600	110	500	220		100	
	220		220	550	230			
MC-75a MC-85a MC-100a	24	230	24	230	24	240	12	110
	48	240	36	240	48	380	20	125
	100	277	42	380	100	415	24	200
	110	380	48	400	110	440	48	220
	120	440	80	415	120	500	60	250
	200	480	100	440	200	550	80	
	208	600	110	500	220		100	
	220		220	550	230			
MC-130a MC-150a					24	300	24	110
					48	400	48	220
					110	500		
					220			



Replacement process

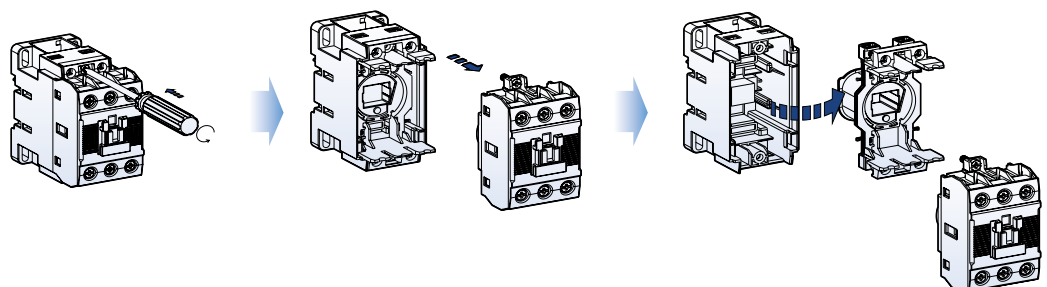

To replace the existing coil to change voltage or repair.



Contactor	Coil voltage	
	AC/DC common coil	AC coil
MC-185a MC-225a	24 48 100~240/100~220	300 400 500
MC-265a MC-300a MC-400a	100~240/100~220	300 400 500
MC-500a MC-630a MC-800a	100/100 200/200	300 400 500

Safety cover (Option)

- To prevent arc from coming out from the contactor
- To protect from unintended manual operation
- To prevent dust from entering into the inside of the contactor



Type	Contactor
AP-9	All types

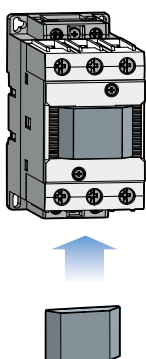

General descriptions

Type MT, bimetal-style, overload relays are designed to protect AC circuits and motors against overloads, phase failure, long starting times and prolonged stalling of the motor.

Four versions are available according to the protection function and trip class as below.

1. Non-differential: 3pole-2bimetal(heater) and trip class 10A
2. Non-differential: 3pole-3bimetal(heater) and trip class 10A
3. Differential: 3pole-3bimetal(heater) and trip class 10A
4. Differential: 3pole-3bimetal(heater) and trip class 20

Configuration of the front

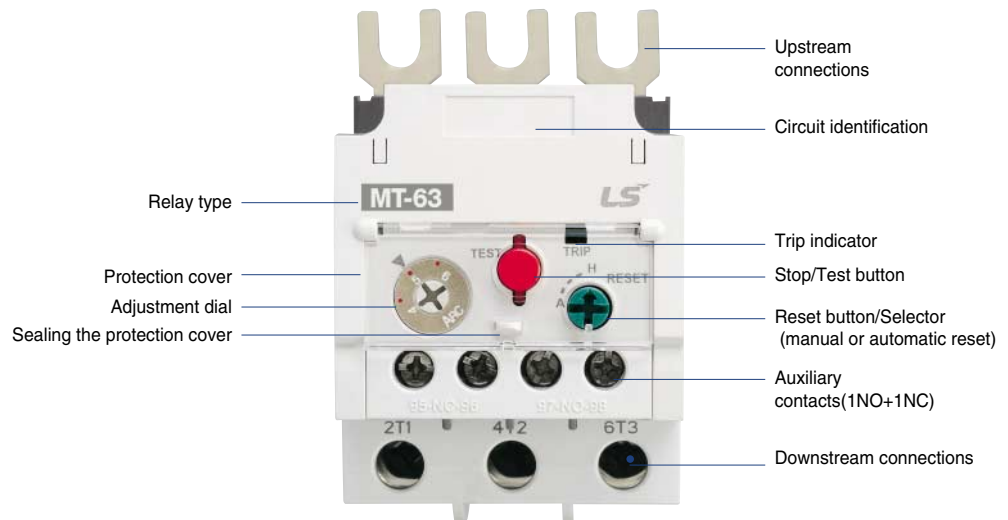

Environment and auxiliary circuit

Environment		MT-12-150	MT-225-800
Standards		IEC/EN 60947-1, IEC/EN 60947-4-1	IEC/EN 60947-1, IEC/EN 60947-4-1
Certifications		CE, CSA, UL	CE, CSA, UL
Rated operation voltage		Max. 690V	Max. 690V
Rated insulation voltage		690V	690V
Rated frequency		50/60Hz	50/60Hz
Degree of protection (Conforming to IEC 60 529)		IP 20	IP 20
Ambient air temperature	Storage	-55 ~ +80° C	-55 ~ +80° C
	Operation	-5 ~ +60° C	-5 ~ +60° C
Mounting position		Vertical plane	Vertical plane
Shock resistance (Conforming to IEC 68-2-7)		15gn - 11ms	15gn - 11ms
Vibration resistance (Conforming to IEC68-2-6)		6G	6G
Insulation strength (Conforming to IEC 255-5)		6kV	6kV
Rated impulse withstand voltage (Conforming to IEC 801-5)		6kV	6kV
Auxiliary contacts characteristics			
Composition		1a1b (1NO +1NC)	1NO+1NC
Rated thermal current		5A	5A
Rated operation current		C600, R300	C600, R300
AC15 duty (C600)	120V	1.5A	2.5A
	240V	0.75A	2A
	380V	0.47A	0.47A
	480V	0.375A	0.375A
	500V	0.35A	0.35A
	600V	0.3A	1A
DC13 duty (R300)	120V	0.22A	0.28A
	240V	0.1A	0.14A
Connecting conductor	Size	18AWG /1 mm ²	18AWG /1 mm ²
Connection to screw clamp terminals	Type	65/75° C Cu-wire	65/75° C Cu-wire

MT-150



MT-225



MT-400



MT-800



Overload relay specifications

MT type Thermal Overload Relays



MT-12/3K□

Frame size		
Trip class		
Type	Non-differential(3P-2 heater) Non-differential(3P-3 heater) Differential type	
Terminal type		
Number of poles		
Rated operational voltage (Ue)		
Rated insulation voltage (Ui)		
Rated impulse voltage (Uimp)		
Degree of protection (IEC 60 529)		
Temperature compensation (° C)		
Functions	Trip indicating Stop Test Manual/Automatic Reset	
Setting range(A)		
Nominal current rating	Wire size	
	mm ²	AWG
0.14	1	18
0.21		
0.33		
0.52		
0.82		
1.3		
2.1		
3.3		
5		
6.5		
7.5	1~1.5	18~16
8.5	1.5~2.5	16~14
15	2.5	14~12
19	2.5~4	12~10
21.5		
27	4~6	10
30	4~10	10~8
34	6~10	10~8
42	10	8
54		
65	16~25	6~4
74		
83	25~35	4~3
90		
Applied contactors		
Separate mounting unit		

18AF	
10A	20
MT-12/2H□	-
MT-12/3H□	-
MT-12/3K□	MT-12/3D□
Screw clamp	
3	
690V	
Up to 690V	
6kV	
IP 20	
-5~+40°C	
■	
-	
■	
■	
0.1~18A	1~18A
0.1~0.16	
0.16~0.25	
0.25~0.4	
0.4~0.63	
0.63~1	
1~1.6	1~1.6
1.6~2.5	1.6~2.5
2.5~4	2.5~4
4~6	4~6
5~8	5~8
6~9	6~9
7~10	7~10
9~13	9~13
12~18	12~18
MC-6a, 9a, 12a, 18a	
-	



MT-32/3K□

40AF

10A	20
MT-32/2H□	-
MT-32/3H□	-
MT-32/3K□	MT-32/3D□
Screw clamp	
3	
690V	
Up to 690V	
6kV	
IP 20	
-5~+40°C	
■	
■	
■	
■	
■	
0.1~40A	1~40A
0.1~0.16	
0.16~0.25	
0.25~0.4	
0.4~0.63	
0.63~1	
1~1.6	1~1.6
1.6~2.5	1.6~2.5
2.5~4	2.5~4
4~6	4~6
5~8	5~8
6~9	6~9
7~10	7~10
9~13	9~13
12~18	12~18
16~22	16~22
18~25	18~25
22~32	22~32
-	-
28~40	28~40
MC-9b, 12b, 18b, 22b, 32a, 40a	
UZ-32	



MT-63/3K□S

65AF

10A	20
MT-63/2H□S	-
MT-63/3H□S	-
MT-63/3K□S	MT-63/3D□S
Screw clamp	
3	
690V	
Up to 690V	
6kV	
IP 20	
-5~+40°C	
■	
■	
■	
■	
■	
■	
4~65A	
4~6	4~6
5~8	5~8
6~9	6~9
7~10	7~10
9~13	9~13
12~18	12~18
16~22	16~22
18~25	18~25
-	-
24~36	24~36
28~40	28~40
34~50	34~50
45~65	45~65
MC-50a, 65a	
UZ-63/S	



MT-95/3K□S

100AF

10A	20
MT-95/2H□S	-
MT-95/3H□S	-
MT-95/3K□S	MT-95/3D□S
Screw clamp	
3	
690V	
Up to 690V	
6kV	
IP 20	
-5~+40°C	
■	
■	
■	
■	
■	
■	
7~100A	
7~10	7~10
9~13	9~13
12~18	12~18
16~22	16~22
18~25	18~25
-	-
24~36	24~36
28~40	28~40
34~50	34~50
45~65	45~65
54~75	54~75
63~85	63~85
70~95	70~95
80~100	80~100
MC-75a, 85a, 100a	
UZ-95/S	

Overload relay specifications

MT type Thermal Overload Relays

Metasol



Frame size		
Trip class		
Type	Non-differential(3P-2 heater)	
	Non-differential(3P-3 heater)	
	Differential type	
Terminal type		
Number of poles		
Rated operational voltage (Ue)		
Rated insulation voltage (Ui)		
Rated impulse voltage (Uimp)		
Degree of protection (IEC 60 529)		
Temperature compensation (°C)		
Functions	Trip indicating	
	Stop	
	Test	
	Manual/Automatic Reset	
Setting range(A)		
Nominal current rating	Wire size	
	mm ²	AWG
42	10	8
55	16	6
65	25	4
74	25	4
80	35	3
93	35	2
107	50	1
113	50	1
130	50	0
130	70	00
153	95	000
200	120	250
265	185	350
350	240	500
515	185 × 2n	350 × 2n
660	240 × 2n	300 × 3n
Applied contactors		
Separate mounting unit		

150AF	
10A	20
MT-150/2H□	-
MT-150/3H□	-
MT-150/3K□	MT-150/3D□
Screw clamp	
3	
690V	
690V	
6kV	
IP 20	
-5~+40°C	
■	
■	
■	
■	
34~150A	34~150A
34~50	
45~65	
54~75	
63~85	
-	
80~105	
-	
95~130	
110~150	
MC-130a, 150a	
UZ-150/S	



225AF

10A	20
MT-225/2H□	-
MT-225/3H□	-
MT-225/3K□	MT-225/3D□

Screw clamp	
3	
690V	
690V	
6kV	
IP 20	
-5~+40°C	
■	
■	
■	
■	

65~240A	65~240A
---------	---------

65~100
-
85~125
-
-
100~160
120~185
160~240

MC-185a, 225a

400AF

10A	20
MT-400/2H□S	-
MT-400/3H□S	-
MT-400/3K□S	MT-400/3D□S

Screw clamp	
3	
690V	
690V	
6kV	
IP 20	
-5~+40°C	
■	
■	
■	
■	

85~400A	85~400A
---------	---------

85~125
-
-
100~160
120~185
160~240
200~330
260~400

MC-265a, 330a, 400a

800AF

10A	20
MT-800/2H□S	-
MT-800/3H□S	-
MT-800/3K□S	MT-800/3D□S

Screw clamp	
3	
690V	
690V	
6kV	
IP 20	
-5~+40°C	
■	
■	
■	
■	

200~800A	200~800A
----------	----------

200~300
260~400
400~600
520~800

MC-500a, 630a, 800a

Overload relay operation

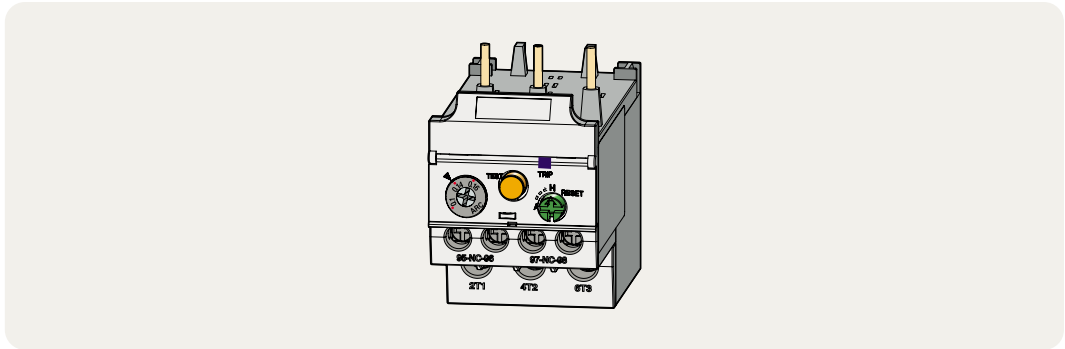
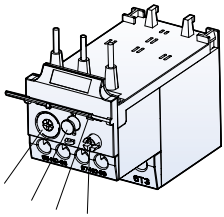

1. Adjustment dial



Before adjusting the dial open the protection cover.
Current setting can be done easily by using (+) or (-) driver.
Do not rotate the dial out of the setting range.

2. Stop/Test button

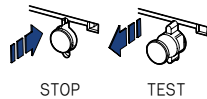

STOP function is executed by pushing the button, which causes the next sequence.
In case of operation test pull this button.

3. Trip indicator

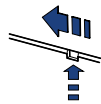

If relay is tripped it comes out.

4. Reset button/Selector

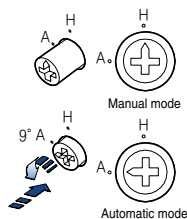

Using a driver the reset mode can be set.
In case of Manual mode(H) push the button to reset the relay.
To change to Automatic mode(A) from Manual mode push the button and rotate as shown in the fig.

5. Auxiliary contact operation

Terminal no.	Normal	STOP	TEST/TRIP	RESET
NC 95-96				
NO 97-98				

Accessories for overload relay

Separate mounting units

These accessories are used to mount the relays separately from contactors. If a relay is combined with a unit, it can be mounted on DIN rail or panel by fixing screws.



Relay	Unit	
	Type	Weight
MT-32/2H□ MT-32/3H□ MT-32/3K□ MT-32/3D□	UZ-32	38g
MT-63/2H□S MT-63/3H□S MT-63/3K□S MT-63/3D□S	UZ-63/S	134g
MT-95/2H□S MT-95/3H□S MT-95/3K□S MT-95/3D□S	UZ-95/S	230g
MT-150/2H□ MT-150/3H□ MT-150/3K□ MT-150/3D□	UZ-150/S	284g

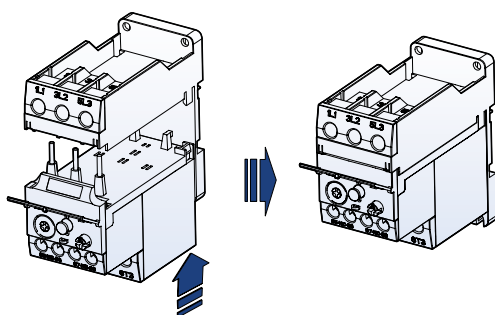

Terminal cover units for overload relays



Relay	Unit type	Remarks
MT-225	APT-225	2 pcs included
MT-400	APT-400	
MT-800	APT-600	

Accessories for overload relay

Remote reset units

These accessories are used to reset the relays on the panel door.



Type	Cable length (L)
UM-4R	400 mm
UM-5R	500 mm
UM-6R	600 mm

1. Make the reset bar straight at least 55mm from the panel door and 35mm from the bracket.
2. The bending radius of the flexible reset bar should not be less than 15mm.

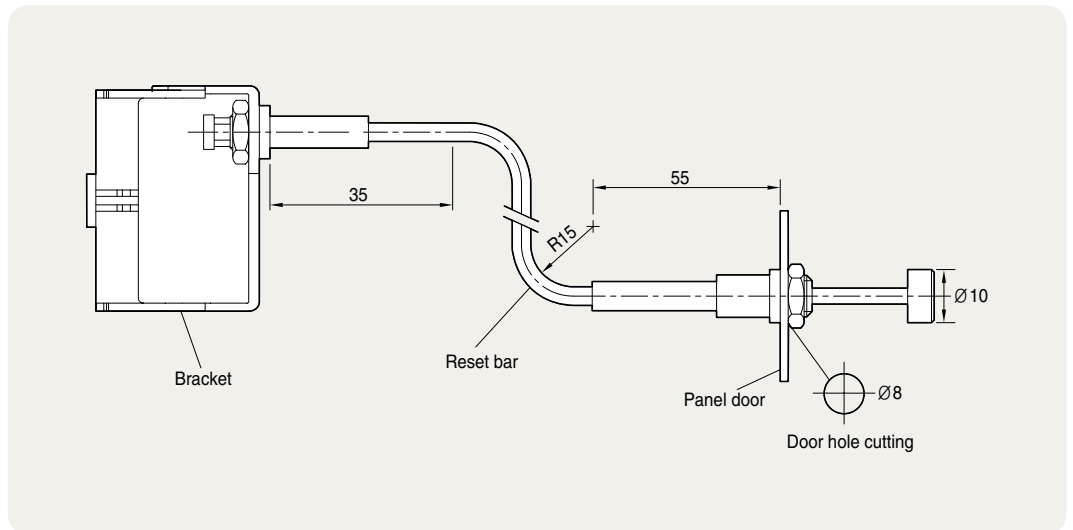

Installation

1. Fit the bracket with the relay as indicated(*1) below.
2. Separate Nut(*3) and Head cap(*4) from the reset bar first.
Insert the reset bar into the panel hole and then fix it with the Nut and Head.
3. To separate the bracket from the relay lift the *2 part as shown in the fig.

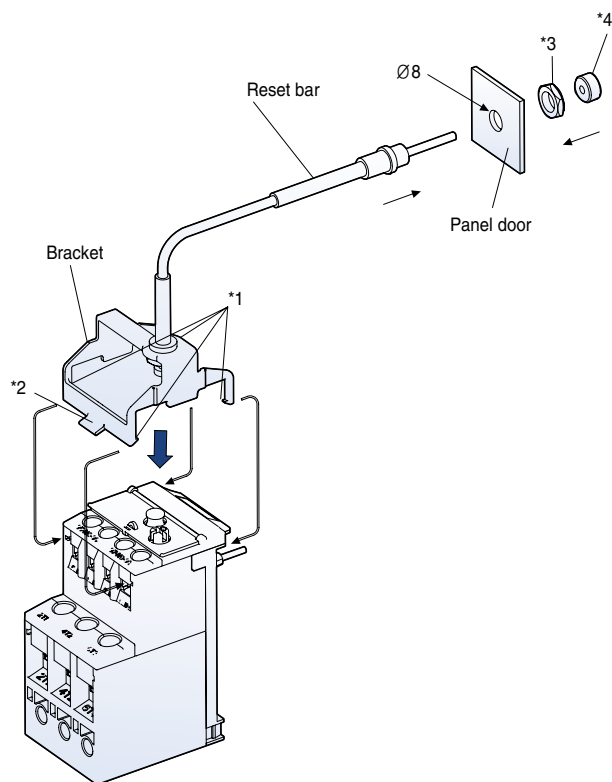
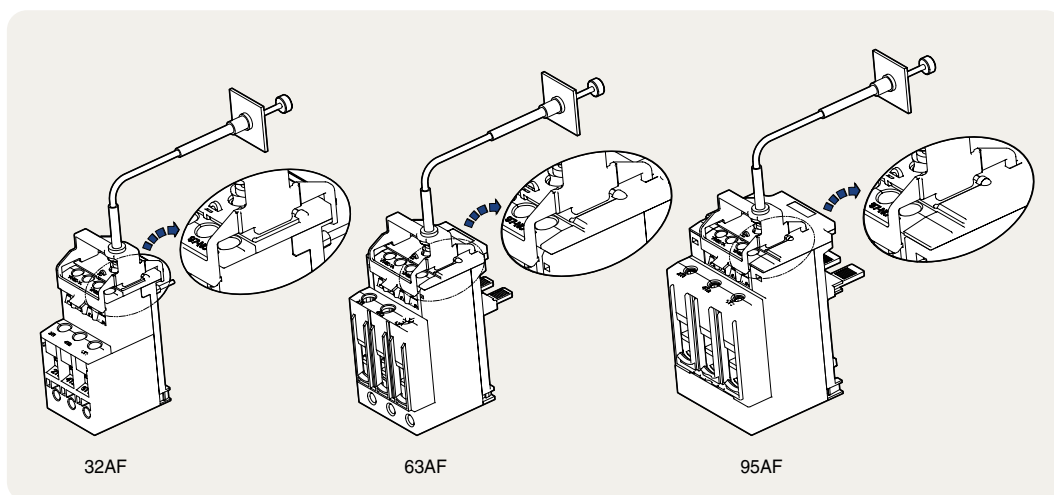

Overload relay ordering types

Trip class 10A

Direct mounting type



MT-12/□

Setting range (A)	Ordering type			Contactor	Separate mounting unit
	Non-differential (3P-2 heater)	Non-differential (3P-3 heater)	Differential		
0.1~0.16	MT-12/2H0.14	MT-12/3H0.14	MT-12/3K0.14	MC-6a MC-9a MC-12a MC-18a	
0.16~0.25	MT-12/2H0.21	MT-12/3H0.21	MT-12/3K0.21		
0.25~0.4	MT-12/2H0.33	MT-12/3H0.33	MT-12/3K0.33		
0.4~0.63	MT-12/2H0.52	MT-12/3H0.52	MT-12/3K0.52		
0.63~1	MT-12/2H0.82	MT-12/3H0.82	MT-12/3K0.82		
1~1.6	MT-12/2H1.3	MT-12/3H1.3	MT-12/3K1.3		
1.6~2.5	MT-12/2H2.1	MT-12/3H2.1	MT-12/3K2.1		
2.5~4	MT-12/2H3.3	MT-12/3H3.3	MT-12/3K3.3		
4~6	MT-12/2H5	MT-12/3H5	MT-12/3K5		
5~8	MT-12/2H6.5	MT-12/3H6.5	MT-12/3K6.5		
6~9	MT-12/2H7.5	MT-12/3H7.5	MT-12/3K7.5		
7~10	MT-12/2H8.5	MT-12/3H8.5	MT-12/3K8.5		
9~13	MT-12/2H11	MT-12/3H11	MT-12/3K11		
12~18	MT-12/2H15	MT-12/3H15	MT-12/3K15		



MT-32/□

Setting range (A)	Ordering type			Contactor	Separate mounting unit
	Non-differential (3P-2 heater)	Non-differential (3P-3 heater)	Differential		
0.1~0.16	MT-32/2H0.14	MT-32/3H0.14	MT-32/3K0.14	MC-9b MC-12b MC-18b MC-22b MC-32a MC-40a	UZ-32
0.16~0.25	MT-32/2H0.21	MT-32/3H0.21	MT-32/3K0.21		
0.25~0.4	MT-32/2H0.33	MT-32/3H0.33	MT-32/3K0.33		
0.4~0.63	MT-32/2H0.52	MT-32/3H0.52	MT-32/3K0.52		
0.63~1	MT-32/2H0.82	MT-32/3H0.82	MT-32/3K0.82		
1~1.6	MT-32/2H1.3	MT-32/3H1.3	MT-32/3K1.3		
1.6~2.5	MT-32/2H2.1	MT-32/3H2.1	MT-32/3K2.1		
2.5~4	MT-32/2H3.3	MT-32/3H3.3	MT-32/3K3.3		
4~6	MT-32/2H5	MT-32/3H5	MT-32/3K5		
5~8	MT-32/2H6.5	MT-32/3H6.5	MT-32/3K6.5		
6~9	MT-32/2H7.5	MT-32/3H7.5	MT-32/3K7.5		
7~10	MT-32/2H8.5	MT-32/3H8.5	MT-32/3K8.5		
9~13	MT-32/2H11	MT-32/3H11	MT-32/3K11		
12~18	MT-32/2H15	MT-32/3H15	MT-32/3K15		
16~22	MT-32/2H19	MT-32/3H19	MT-32/3K19		
18~25	MT-32/2H21.5	MT-32/3H21.5	MT-32/3K21.5		
22~32	MT-32/2H27	MT-32/3H27	MT-32/3K27		
28~40	MT-32/2H34	MT-32/3H34	MT-32/3K34		

Trip class 10A

Direct mounting type



MT-63/□

Setting range (A)	Ordering type			Contactor	Separate mounting unit
	Non-differential (3P-2 heater)	Non-differential (3P-3 heater)	Differential		
4~6	MT-63/2H5S	MT-63/3H5S	MT-63/3K5S	MC-50a MC-65a	UZ-63/S
5~8	MT-63/2H6.5S	MT-63/3H6.5S	MT-63/3K6.5S		
6~9	MT-63/2H7.5S	MT-63/3H7.5S	MT-63/3K7.5S		
7~10	MT-63/2H8.5S	MT-63/3H8.5S	MT-63/3K8.5S		
9~13	MT-63/2H11S	MT-63/3H11S	MT-63/3K11S		
12~18	MT-63/2H15S	MT-63/3H15S	MT-63/3K15S		
16~22	MT-63/2H19S	MT-63/3H19S	MT-63/3K19S		
18~25	MT-63/2H21.5S	MT-63/3H21.5S	MT-63/3K21.5S		
24~36	MT-63/2H30S	MT-63/3H30S	MT-63/3K30S		
28~40	MT-63/2H34S	MT-63/3H34S	MT-63/3K34S		
34~50	MT-63/2H42S	MT-63/3H42S	MT-63/3K42S		
45~65	MT-63/2H55S	MT-63/3H55S	MT-63/3K55S		



MT-95/□

Setting range (A)	Ordering type			Contactor	Separate mounting unit
	Non-differential (3P-2 heater)	Non-differential (3P-3 heater)	Differential		
7~10	MT-95/2H8.5S	MT-95/3H8.5S	MT-95/3K8.5S	MC-75a MC-85a MC-100a	UZ-95/S
9~13	MT-95/2H11S	MT-95/3H11S	MT-95/3K11S		
12~18	MT-95/2H15S	MT-95/3H15S	MT-95/3K15S		
16~22	MT-95/2H19S	MT-95/3H19S	MT-95/3K19S		
18~25	MT-95/2H21.5S	MT-95/3H21.5S	MT-95/3K21.5S		
24~36	MT-95/2H30S	MT-95/3H30S	MT-95/3K30S		
28~40	MT-95/2H34S	MT-95/3H34S	MT-95/3K34S		
34~50	MT-95/2H42S	MT-95/3H42S	MT-95/3K42S		
45~65	MT-95/2H55S	MT-95/3H55S	MT-95/3K55S		
54~75	MT-95/2H65S	MT-95/3H65S	MT-95/3K65S		
63~85	MT-95/2H74S	MT-95/3H74S	MT-95/3K74S		
70~95	MT-95/2H83S	MT-95/3H83S	MT-95/3K83S		
80~100	MT-95/2H90S	MT-95/3H90S	MT-95/3K90S		

Overload relay ordering types

Trip class 10A



MT-150



MT-150/□

Setting range (A)	Ordering type			Contactor	Separate mounting unit
	Non-differential		Differential		
	(3P-2 heater)	(3P-3 heater)			
34~50	MT-150/2H42	MT-150/3H42	MT-150/3K42	MC-130a MC-150a	UZ-150/S
45~65	MT-150/2H55	MT-150/3H55	MT-150/3K55		
54~75	MT-150/2H65	MT-150/3H65	MT-150/3K65		
63~85	MT-150/2H74	MT-150/3H74	MT-150/3K74		
80~105	MT-150/2H93	MT-150/3H93	MT-150/3K93		
95~130	MT-150/2H113	MT-150/3H113	MT-150/3K113		
110~150	MT-150/2H130	MT-150/3H130	MT-150/3K130		

MT-225



MT-225/□

Setting range (A)	Ordering type			Contactor	Remarks
	Non-differential		Differential		
	(3P-2 heater)	(3P-3 heater)			
65~100	MT-225/2H80	MT-225/3H80	MT-225/3K80	MC-185a MC-225a	-
85~125	MT-225/2H107	MT-225/3H107	MT-225/3K107		
100~160	MT-225/2H130	MT-225/3H130	MT-225/3K130		
120~185	MT-225/2H153	MT-225/3H153	MT-225/3K153		
160~240	MT-225/2H200	MT-225/3H200	MT-225/3K200		

MT-400



MT-400/□

Setting range (A)	Ordering type			Contactor	Remarks
	Non-differential		Differential		
	(3P-2 heater)	(3P-3 heater)			
85~125	MT-400/2H107	MT-400/3H107	MT-400/3K107	MC-265a MC-330a MC-400a	-
100~160	MT-400/2H130	MT-400/3H130	MT-400/3K130		
120~185	MT-400/2H153	MT-400/3H153	MT-400/3K153		
160~240	MT-400/2H200	MT-400/3H200	MT-400/3K200		
200~330	MT-400/2H265	MT-400/3H265	MT-400/3K265		
260~400	MT-400/2H350	MT-400/3H350	MT-400/3K350		

MT-800



MT-800/□

Setting range (A)	Ordering type			Contactor	Remarks
	Non-differential		Differential		
	(3P-2 heater)	(3P-3 heater)			
200~330	MT-800/2H265	MT-800/3H265	MT-800/3K265	MC-500a MC-630a MC-800a	-
260~400	MT-800/2H350	MT-800/3H350	MT-800/3K350		
400~630	MT-800/2H515	MT-800/3H515	MT-800/3K515		
520~800	MT-800/2H660	MT-800/3H660	MT-800/3K660		

Trip class 20

Direct mounting type



MT-12/3D□

Setting range (A)	Ordering type	Contactor	Separate mounting unit
	Differential		
1~1.6	MT-12/3D1.3	MC-6a MC-9a MC-12a MC-18a	-
1.6~2.5	MT-12/3D2.1		
2.5~4	MT-12/3D3.3		
4~6	MT-12/3D5		
5~8	MT-12/3D6.5		
6~9	MT-12/3D7.5		
7~10	MT-12/3D8.5		
9~13	MT-12/3D11		
12~18	MT-12/3D15		



MT-32/3D□

Setting range (A)	Ordering type	Contactor	Separate mounting unit
	Differential		
1~1.6	MT-32/3D1.3	MC-9b MC-12b MC-18b MC-22b MC-32a MC-40a	UZ-32
1.6~2.5	MT-32/3D2.1		
2.5~4	MT-32/3D3.3		
4~6	MT-32/3D5		
5~8	MT-32/3D6.5		
6~9	MT-32/3D7.5		
7~10	MT-32/3D8.5		
9~13	MT-32/3D11		
12~18	MT-32/3D15		
16~22	MT-32/3D19		
18~25	MT-32/3D21.5		
22~32	MT-32/3D27		
28~40	MT-32/3D34		

Overload relay ordering types

Trip class 20

Direct mounting type



MT-63/3D□S

Setting range (A)	Ordering type	Contactor	Separate mounting unit
	Differential		
4~6	MT-63/3D5S	MC-50a MC-65a	UZ-63/S
5~8	MT-63/3D6.5S		
6~9	MT-63/3D7.5S		
7~10	MT-63/3D8.5S		
9~13	MT-63/3D11S		
12~18	MT-63/3D15S		
16~22	MT-63/3D19S		
18~25	MT-63/3D21.5S		
24~36	MT-63/3D30S		
28~40	MT-63/3D34S		
34~50	MT-63/3D42S		
45~65	MT-63/3D55S		



MT-95/3D□S

Setting range (A)	Ordering type	Contactor	Separate mounting unit
	Differential		
7~10	MT-95/3D8.5S	MC-75a MC-85a MC-100a	UZ-95/S
9~13	MT-95/3D11S		
12~18	MT-95/3DK15S		
16~22	MT-95/3D19S		
18~25	MT-95/3D21.5S		
24~36	MT-95/3D30S		
28~40	MT-95/3D34S		
34~50	MT-95/3D42S		
45~65	MT-95/3D55S		
54~75	MT-95/3D65S		
63~85	MT-95/3D74S		
70~95	MT-95/3D83S		
80~100	MT-95/3D90S		

Trip class 20



MT-150



MT-150/3D □

Setting range (A)	Ordering type	Contactor	Separate mounting unit
	Differential		
34~50	MT-150/3D42	MC-130a MC-150a	UZ-150/S
45~65	MT-150/3D55		
54~75	MT-150/3D65		
63~85	MT-150/3D74		
80~105	MT-150/3D93		
95~130	MT-150/3D113		
110~150	MT-150/3D130		

MT-225



MT-225/3D □

Setting range (A)	Ordering type	Contactor	Remarks
	Differential		
65~100	MT-225/3D80	MC-185a MC-225a	-
85~125	MT-225/3D107		
100~160	MT-225/3D130		
120~185	MT-225/3D153		
160~240	MT-225/3D200		

MT-400



MT-400/3D □

Setting range (A)	Ordering type	Contactor	Remarks
	Differential		
85~125	MT-400/3D107	MC-265a MC-330a MC-400a	-
100~160	MT-400/3D130		
120~185	MT-400/3D153		
160~240	MT-400/3D200		
200~330	MT-400/3D265		
260~400	MT-400/3D350		

MT-800



MT-800/3D □

Setting range (A)	Ordering type	Contactor	Remarks
	Differential		
200~330	MT-800/3D265	MC-500a MC-630a MC-800a	-
260~400	MT-800/3D350		
400~630	MT-800/3D515		
520~800	MT-800/3D660		

Overload relay trip curves

Class 10A, 18AF

- MT-12/2H
- MT-12/3H
- MT-12/3K

Cold starting

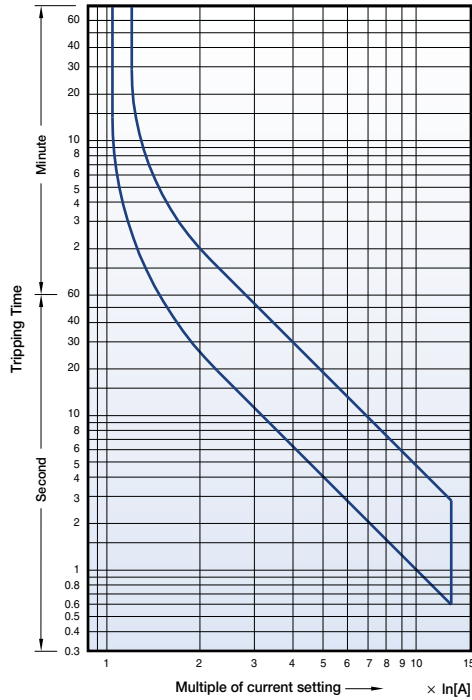

Hot starting

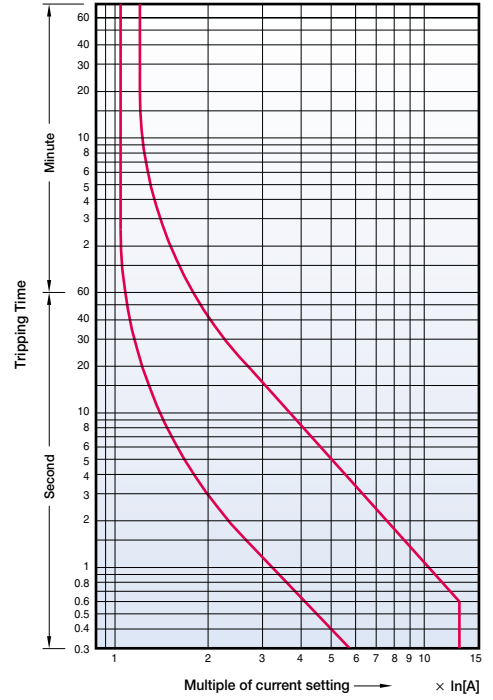

Class 20, 18AF

- MT-12/3D

Cold starting

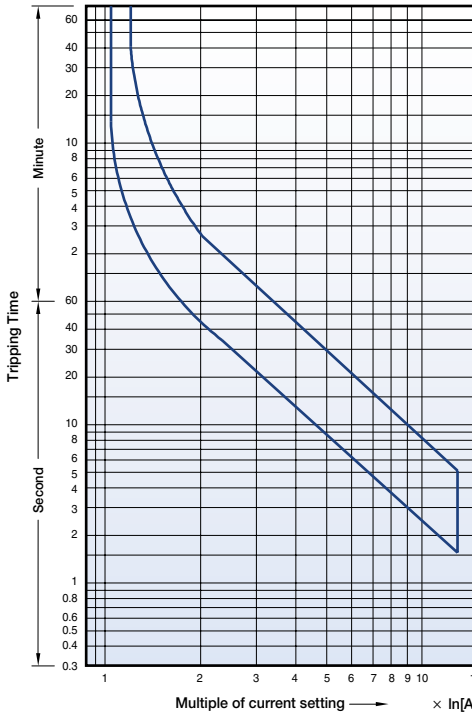

Hot starting

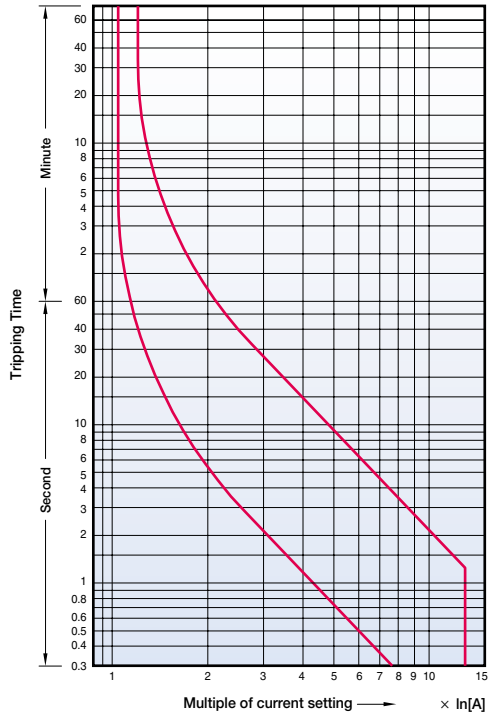

Class 10A, 40AF

- MT-32/2H
- MT-32/3H
- MT-32/3K

Cold starting

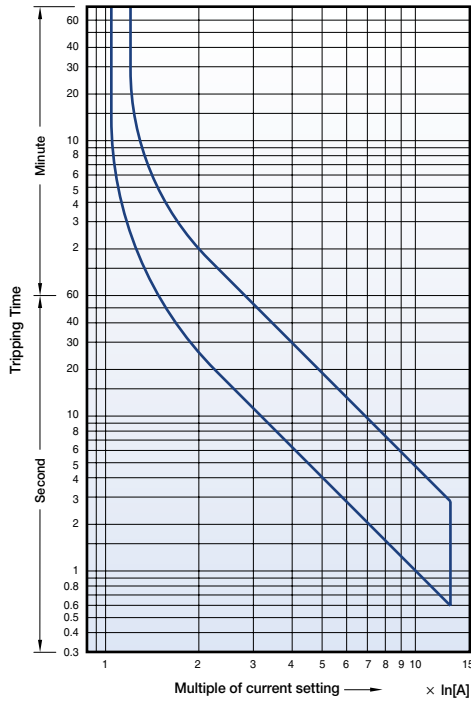

Hot starting

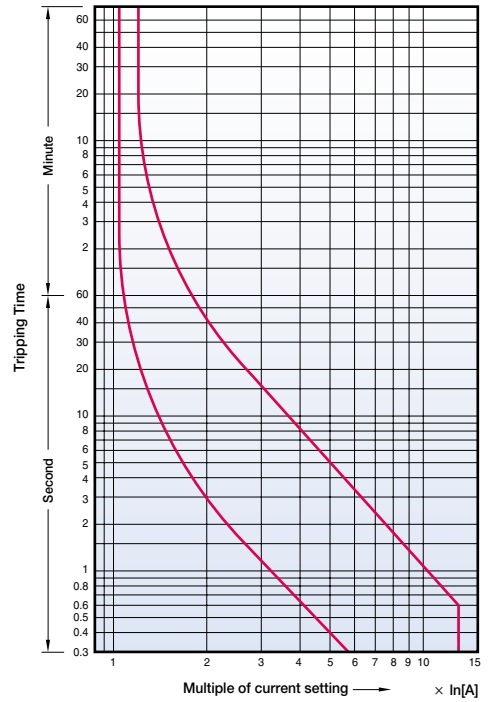

Class 20, 40AF

- MT-32/3D

Cold starting

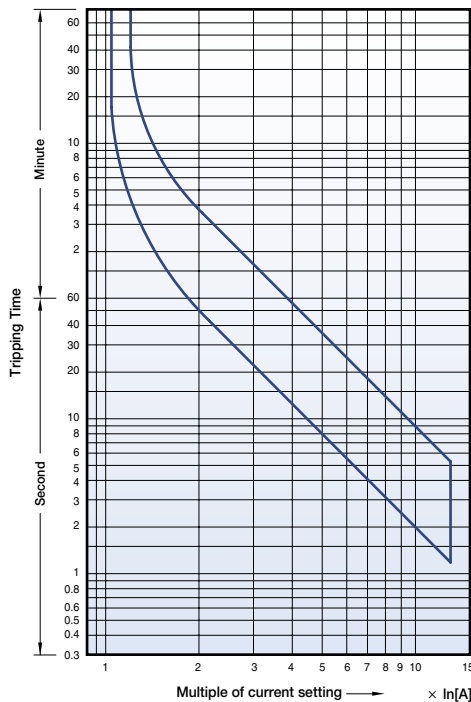

Hot starting

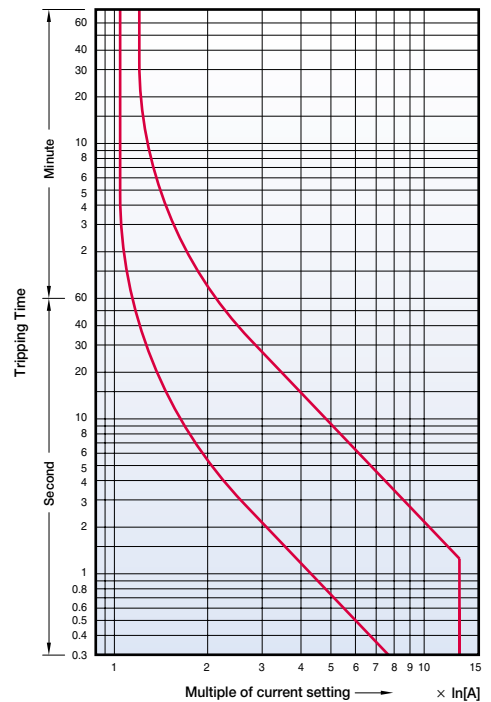

Overload relay trip curves

Class 10A, 65AF

- MT-63/2H
- MT-63/3H
- MT-63/3K

Cold starting

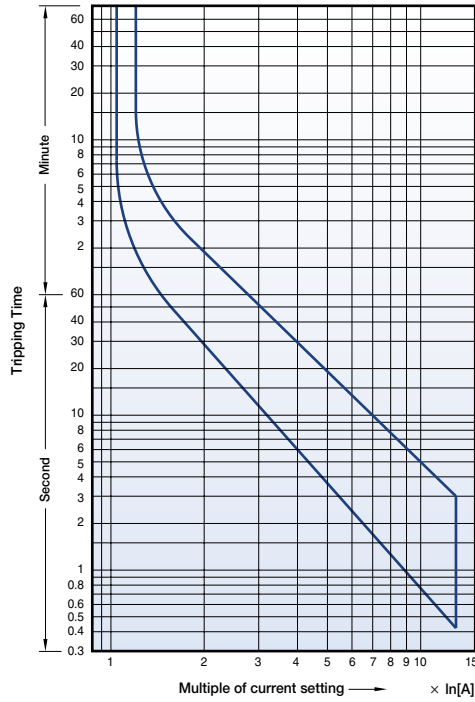

Hot starting

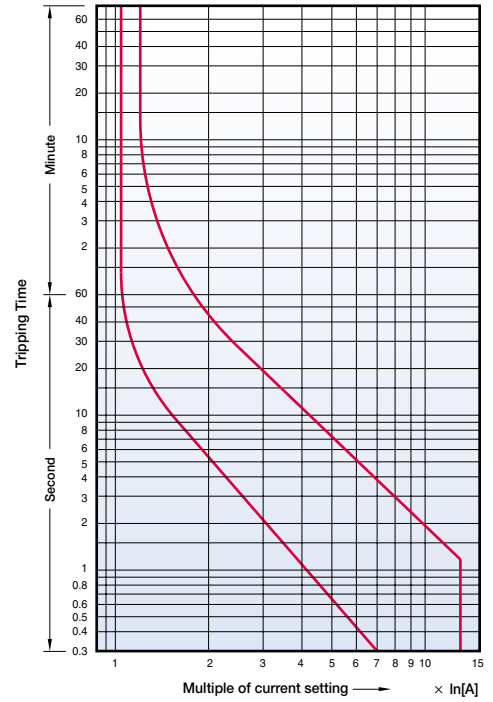

Class 20, 65AF

- MT-63/3D

Cold starting

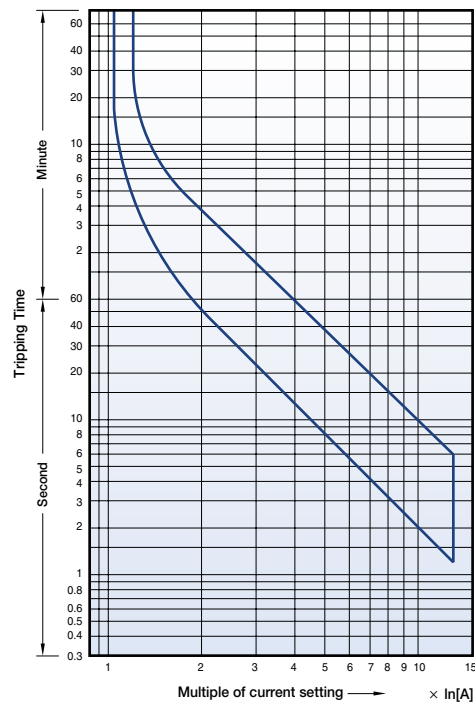

Hot starting

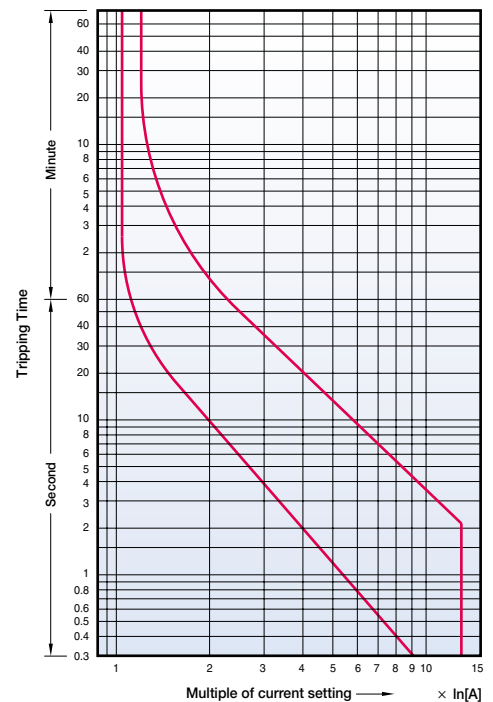

Class 10A, 100AF

- MT-95/2H
- MT-95/3H
- MT-95/3K

Cold starting

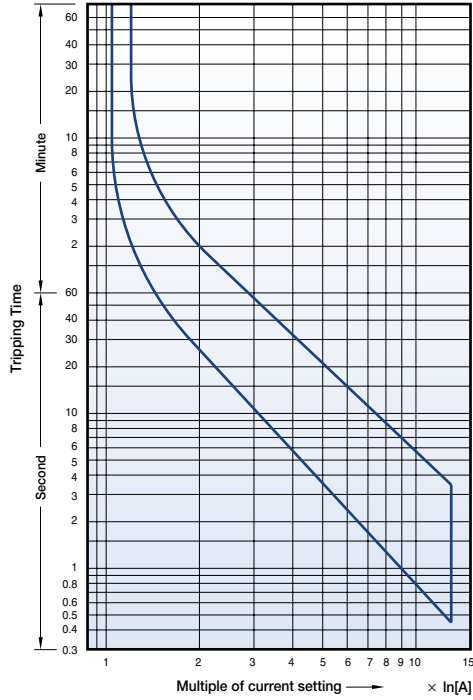

Hot starting

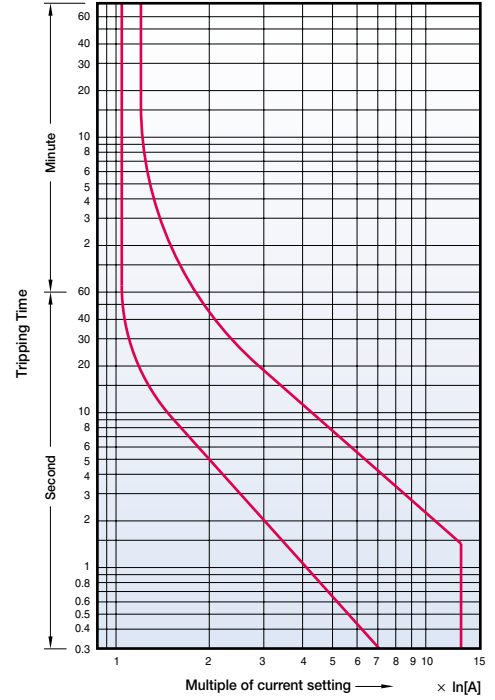

Class 20, 100AF

- MT-95/3D

Cold starting

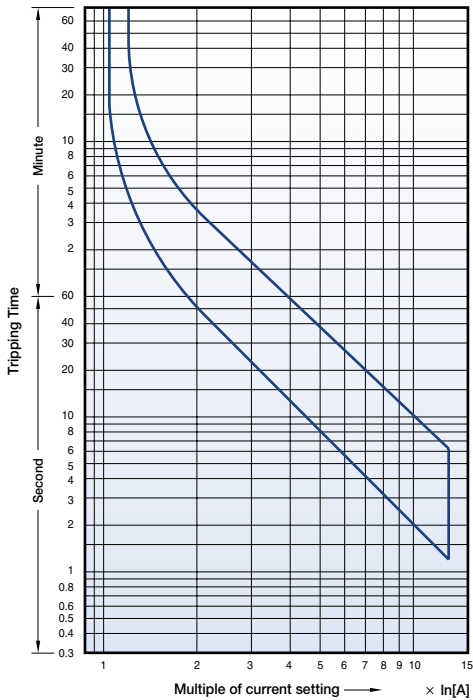

Hot starting

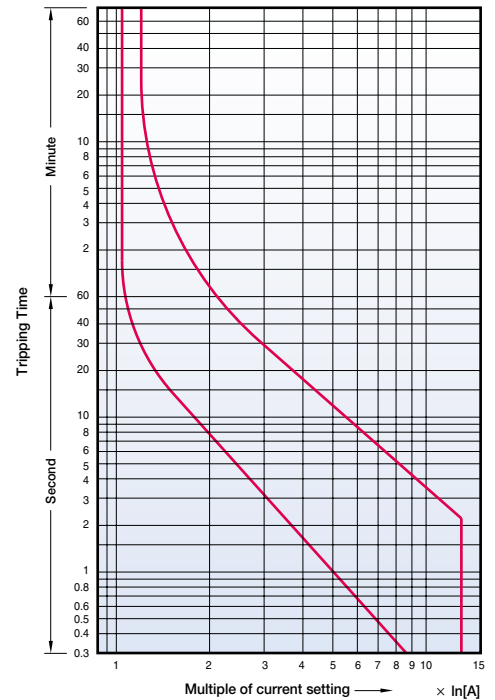

Overload relay trip curves

Class 10A, 150AF

- MT-150/2H
- MT-150/3H
- MT-150/3K

Cold starting

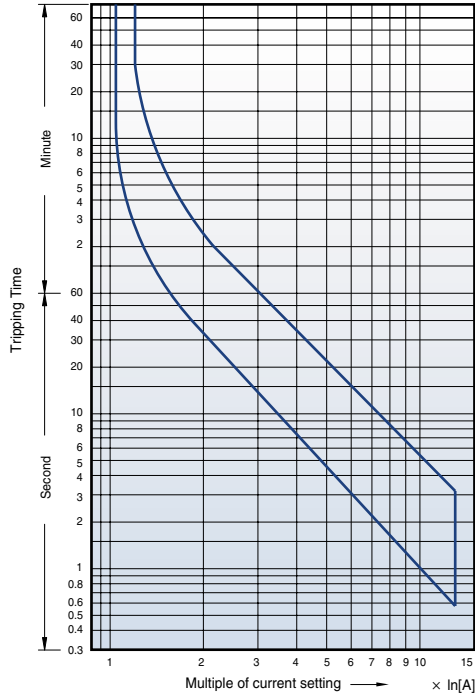

Hot starting

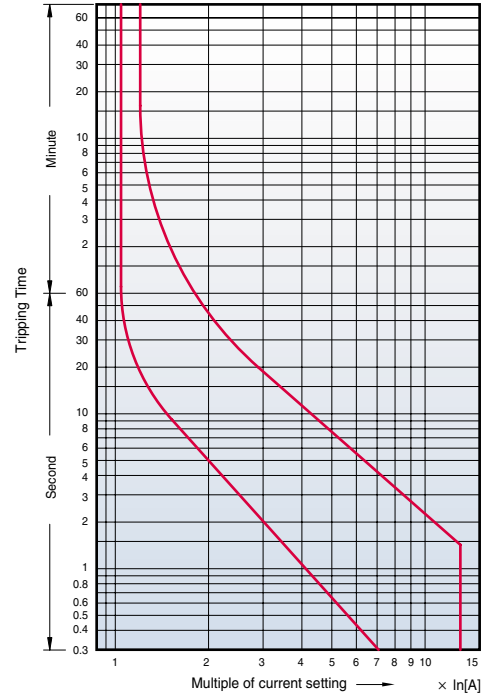

Class 20, 150AF

- MT-150/3D

Cold starting

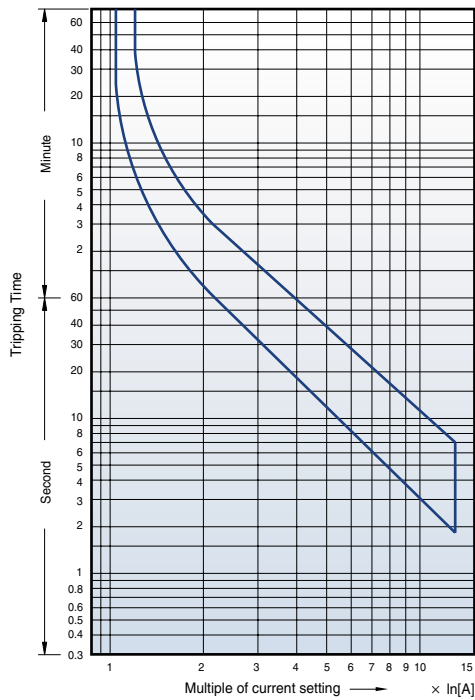

Hot starting

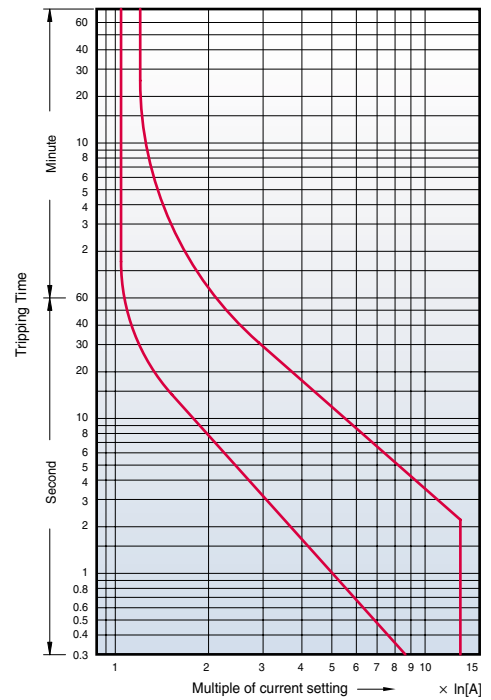

Class 10A, 225AF

- MT-225/2H
- MT-225/3H
- MT-225/3K

Cold starting

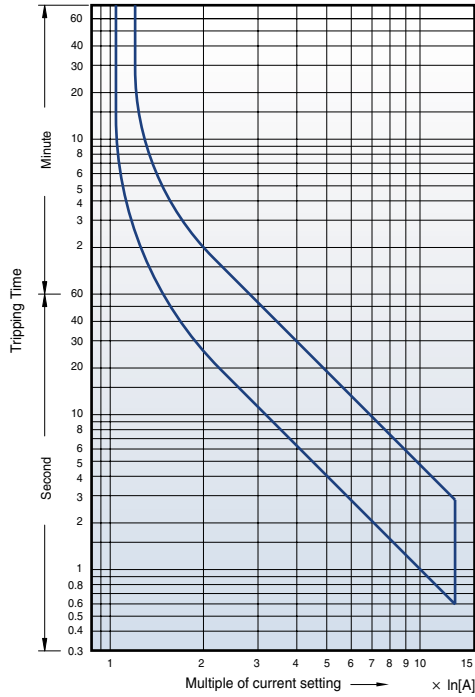

Hot starting

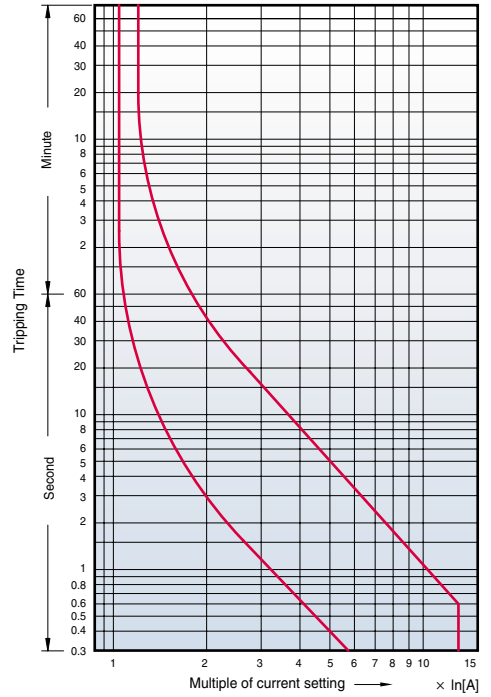

Class 20, 225AF

- MT-225/3D

Cold starting

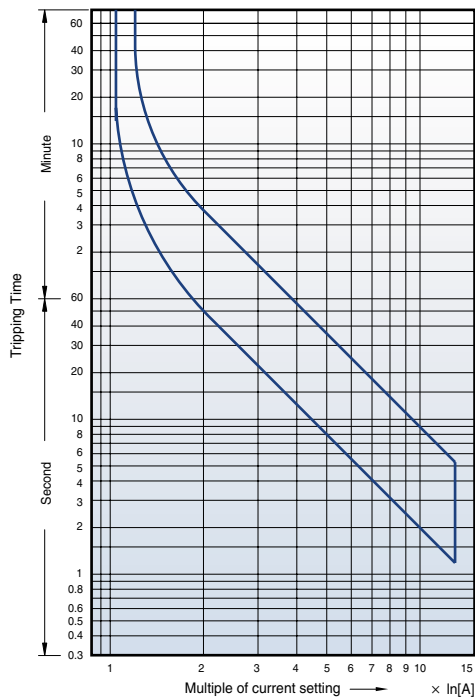

Hot starting

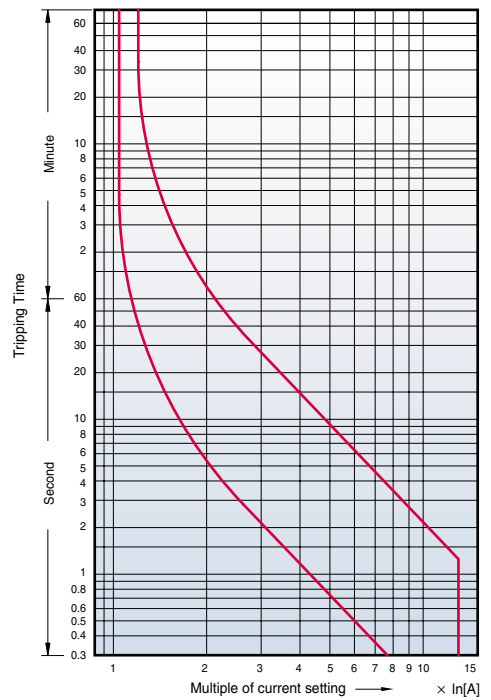

Overload relay trip curves

Class 10A, 400AF

- MT-400/2H
- MT-400/3H
- MT-400/3K

Cold starting

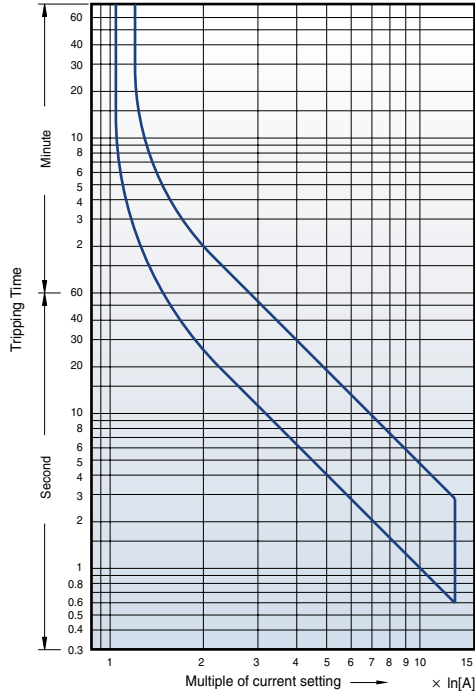

Hot starting

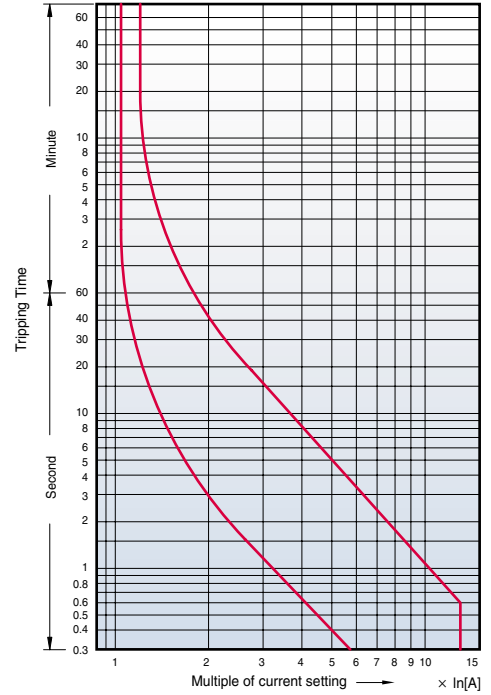

Class 20, 400AF

- MT-400/3D

Cold starting

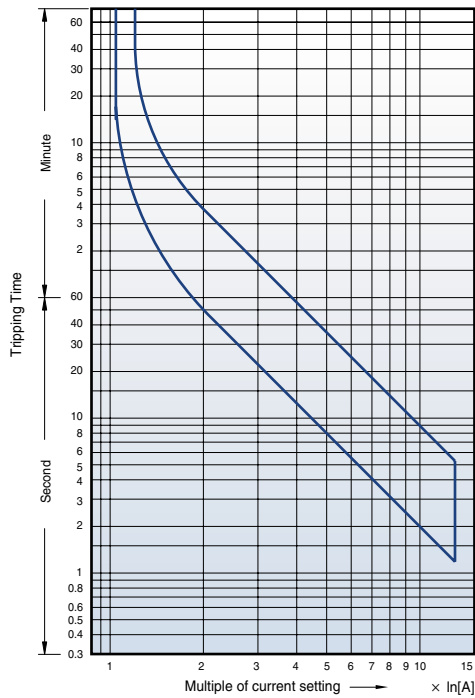

Hot starting

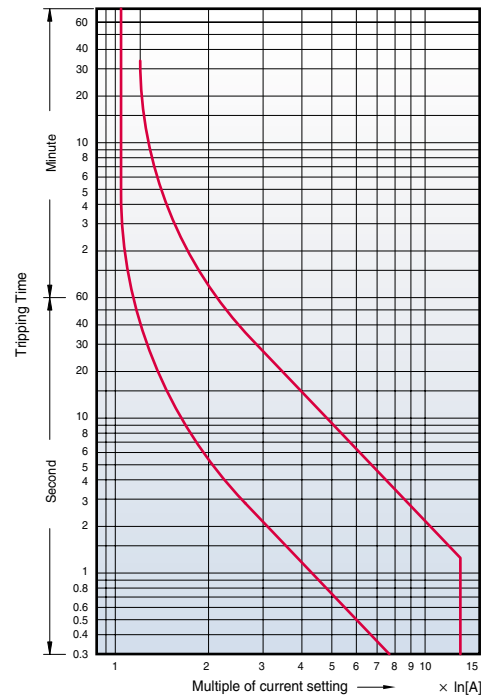

Class 10A, 800AF

- MT-800/2H
- MT-800/3H
- MT-800/3K

Cold starting

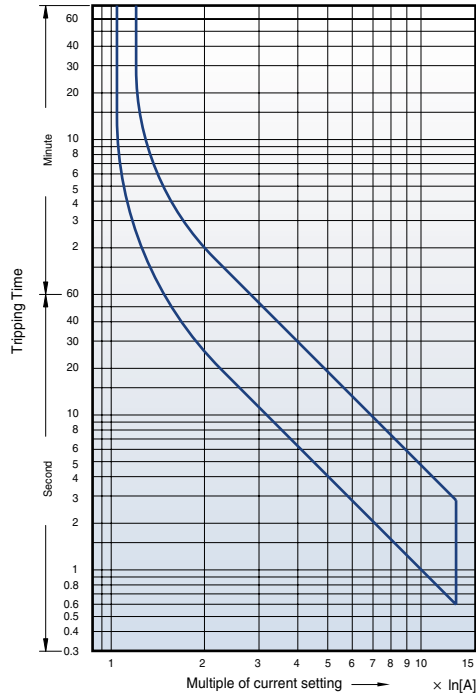

Hot starting

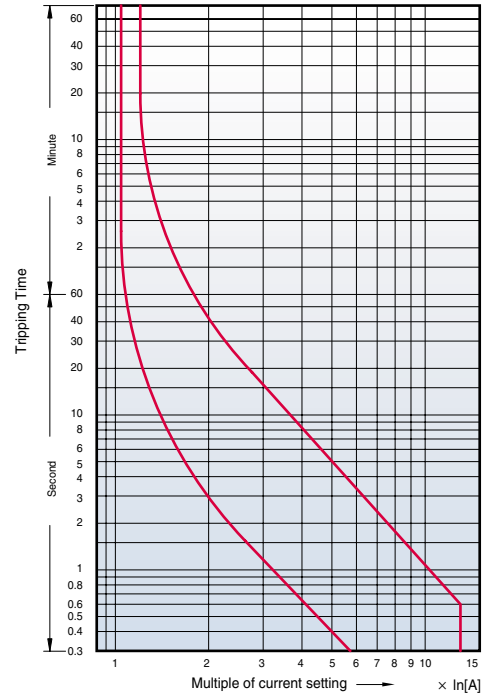

Class 20, 800AF

- MT-800/3D

Cold starting

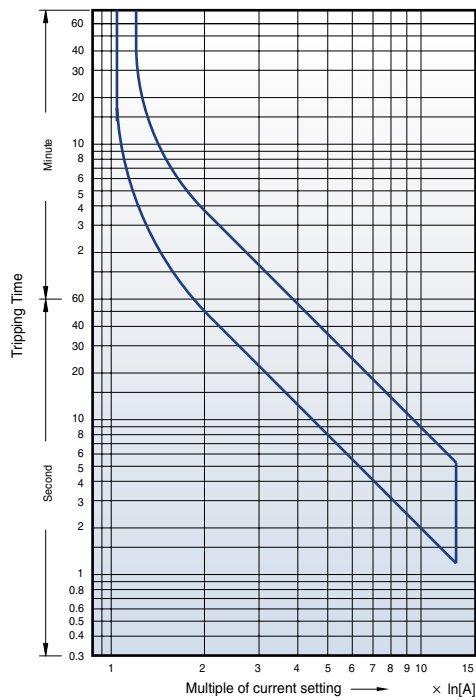

Hot starting

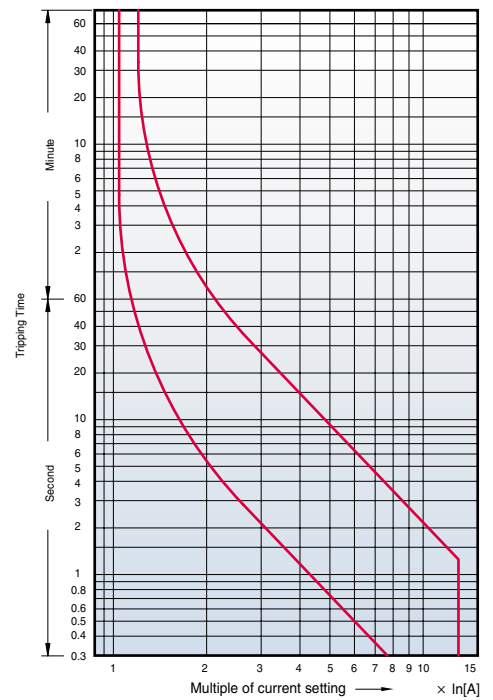

Type 2 Coordination (380/415V)

415V

HI type MMS + Susol MCCB

kW	Rated Operational Power			Circuit Breaker		Contactor	Thermal Overload Relays		Short Circuit Breaking Capacity	
	Current [A]			Type	Rating [A]	Type	Type	Setting Range [A]	Ir [kA]	Iq [kA]
	380V	400V	415V							
0.06	0.21	0.20	0.19	MMS-32HI	0.25	MC-6a	MT-12	0.16~0.25	1	50
0.09	0.32	0.30	0.29	MMS-32HI	0.4	MC-6a	MT-12	0.25~0.4	1	50
0.12	0.46	0.44	0.42	MMS-32HI	0.63	MC-6a	MT-12	0.4~0.63	1	50
0.18	0.63	0.60	0.58	MMS-32HI	0.63	MC-6a	MT-12	0.4~0.63	1	50
0.25	0.89	0.85	0.82	MMS-32HI	1	MC-6a	MT-12	0.63~1	1	50
0.37	1.16	1.10	1.06	MMS-32HI	1.6	MC-12a,12b	MT-12	1~1.6	1	50
0.55	1.6	1.5	1.4	MMS-32HI	1.6	MC-12a,12b	MT-12	1~1.6	1	50
0.75	2.0	1.9	1.8	MMS-32HI	2.5	MC-12a,12b	MT-12	1.6~2.5	1	50
1.1	2.8	2.7	2.6	MMS-32HI	4	MC-22b	MT-32	2.5~4	1	50
1.5	3.8	3.6	3.5	MMS-32HI	4	MC-22b	MT-32	2.5~4	1	50
2.2	5.2	4.9	4.7	MMS-32HI	6	MC-22b	MT-32	4~6	1	50
3.0	6.8	6.5	6.3	MMS-32HI	8	MC-40a	MT-32	5~8	1	50
4.0	8.9	8.5	8.2	MMS-32HI	10	MC-40a	MT-32	6~9	1	50
5.5	12.1	11.5	11.1	MMS-32HI	13	MC-40a	MT-32	9~13	3	50
7.5	16.3	15.5	14.9	MMS-32HI	17	MC-40a	MT-32	12~18	3	50
11.0	23.2	22.0	21.2	TD100	25	MC-50a	MT-63	18~25	3	70
15.0	31	29	28	TD100	32	MC-50a	MT-63	24~36	3	70
18.5	37	35	34	TD100	40	MC-50a	MT-63	28~40	3	70
22	43	41	40	TD100	50	MC-50a	MT-63	34~50	3	70
30	58	55	53	TD100	63	MC-65a	MT-63	45~65	3	70
37	69	66	64	TD100	80	MC-75a	MT-95	54~75	5	70
45	84	80	77	TD100	100	MC-85a	MT-95	63~85	5	70
55	-	-	93	TD100	100	MC-100a	MT-95	70~95	5	70

415V

H type MMS + Susol MCCB

Rated Operational Power				Circuit Breaker		Contactor	Thermal Overload Relays		Short Circuit Breaking Capacity	
kW	Current [A]			Type	Rating [A]	Type	Type	Setting Range [A]	Ir [kA]	Iq [kA]
	380V	400V	415V							
0.06	0.21	0.20	0.19	MMS-32H	0.25	MC-6a			1	50
0.09	0.32	0.30	0.29	MMS-32H	0.4	MC-6a			1	50
0.12	0.46	0.44	0.42	MMS-32H	0.63	MC-6a			1	50
0.18	0.63	0.60	0.58	MMS-32H	0.63	MC-6a			1	50
0.25	0.89	0.85	0.82	MMS-32H	1	MC-6a			1	50
0.37	1.16	1.10	1.06	MMS-32H	1.6	MC-12a,12b			1	50
0.55	1.6	1.5	1.4	MMS-32H	1.6	MC-12a,12b			1	50
0.75	2.0	1.9	1.8	MMS-32H	2.5	MC-12a,12b			1	50
1.1	2.8	2.7	2.6	MMS-32H	4	MC-22b			1	50
1.5	3.8	3.6	3.5	MMS-32H	4	MC-22b			1	50
2.2	5.2	4.9	4.7	MMS-32H	6	MC-22b			1	50
3.0	6.8	6.5	6.3	MMS-32H	8	MC-40a			1	50
4.0	8.9	8.5	8.2	MMS-32H	10	MC-40a			1	50
5.5	12.1	11.5	11.1	MMS-32H	13	MC-40a			3	50
7.5	16.3	15.5	14.9	MMS-32H	17	MC-40a			3	50
11.0	23.2	22.0	21.2	TD100	25	MC-50a	MT-63	18-25	3	70
15.0	31	29	28	TD100	32	MC-50a	MT-63	24-36	3	70
18.5	37	35	34	TD100	40	MC-50a	MT-63	28-40	3	70
22	43	41	40	TD100	50	MC-50a	MT-63	34-50	3	70
30	58	55	53	TD100	63	MC-65a	MT-63	45-65	3	70
37	69	66	64	TD100	80	MC-75a	MT-95	54-75	5	70
45	84	80	77	TD100	100	MC-85a	MT-95	63-85	5	70
55	-	-	93	TD100	100	MC-100a	MT-95	70-95	5	70

Type 2 Coordination (380/415V)

415V

Susol MCCB

kW	Rated Operational Power			Circuit Breaker		Contactor	Thermal Overload Relays		Short Circuit Breaking Capacity	
	Current [A]			Type	Rating [A]	Type	Type	Setting Range [A]	Ir [kA]	Iq [kA]
	380V	400V	415V							
0.06	0.21	0.20	0.19	TS100 (1)	1.6	MC-6a	MT-12	0.16~0.25	1	50
0.09	0.32	0.30	0.29	TS100 (1)	1.6	MC-6a	MT-12	0.25~0.4	1	50
0.12	0.46	0.44	0.42	TS100 (1)	1.6	MC-6a	MT-12	0.4~0.63	1	50
0.18	0.63	0.60	0.58	TS100 (1)	1.6	MC-6a	MT-12	0.4~0.63	1	50
0.25	0.89	0.85	0.82	TS100 (1)	1.6	MC-6a	MT-12	0.63~1	1	50
0.37	1.16	1.10	1.06	TS100 (1)	1.6	MC-12a,12b	MT-12	1~1.6	1	50
0.55	1.6	1.5	1.4	TS100 (1)	1.6	MC-12a,12b	MT-12	1~1.6	1	50
0.75	2.0	1.9	1.8	TS100 (1)	1.6	MC-12a,12b	MT-12	1.6~2.5	1	50
1.1	2.8	2.7	2.6	TS100 (1)	3.2	MC-22b	MT-32	2.5~4	1	50
1.5	3.8	3.6	3.5	TS100 (1)	3.2	MC-22b	MT-32	2.5~4	1	50
2.2	5.2	4.9	4.7	TS100 (1)	3.2	MC-22b	MT-32	4~6	1	50
3.0	6.8	6.5	6.3	TS100 (1)	6.3	MC-40a	MT-32	5~8	1	50
4.0	8.9	8.5	8.2	TS100 (1)	6.3	MC-40a	MT-32	6~9	1	50
5.5	12.1	11.5	11.1	TS100 (1)	12	MC-40a	MT-32	9~13	3	50
7.5	16.3	15.5	14.9	TS100 (1)	12	MC-40a	MT-32	12~18	3	50
11.0	23.2	22.0	21.2	TD100	25	MC-50a	MT-63	18~25	3	70
15.0	31	29	28	TD100	32	MC-50a	MT-63	24~36	3	70
18.5	37	35	34	TD100	40	MC-50a	MT-63	28~40	3	70
22	43	41	40	TD100	50	MC-50a	MT-63	34~50	3	70
30	58	55	53	TD100	63	MC-65a	MT-63	45~65	3	70
37	69	66	64	TD100	80	MC-75a	MT-95	54~75	5	70
45	84	80	77	TD100	100	MC-85a	MT-95	63~85	5	70
55	-	-	93	TD100	100	MC-100a	MT-95	70~95	5	70

Note) (1) This marks admit for motor protection MTU trip unit only.

Rated short circuit breaking capacity of installation

Manual Motor Starter	Adjustment Range (A)	Manual Motor Controller Group Installation			Applied Contactor (Susol MC)	Applied Contactor (Metasol MC)	Applied Contactor (Meta-MEC GMC)
		Short Circuit Rating(KAIC)					
		240V	480Y/277V	600Y/347V			
32AF Rotary operation, standard interruption							
MMS-32H-0.16	0.1~0.16	100	65	25	MC-9	MC-6a/MC-9a/MC-9b	GMC-6M/GMC-9
MMS-32H-0.25	0.16~0.25	100	65	25	MC-9	MC-6a/MC-9a/MC-9b	GMC-6M/GMC-9
MMS-32H-0.4	0.25~0.4	100	65	25	MC-9	MC-6a/MC-9a/MC-9b	GMC-6M/GMC-9
MMS-32H-0.63	0.4~0.63	100	65	25	MC-9	MC-6a/MC-9a/MC-9b	GMC-6M/GMC-9
MMS-32H-1	0.63~1	100	65	25	MC-9	MC-6a/MC-9a/MC-9b	GMC-6M/GMC-9
MMS-32H-1.6	1~1.6	100	65	25	MC-9	MC-6a/MC-9a/MC-9b	GMC-9M/GMC-9
MMS-32H-2.5	1.6~2.5	100	65	25	MC-12	MC-12a/MC-12b	GMC-12M/GMC-12
MMS-32H-4	2.5~4	100	65	25	MC-12	MC-12a/MC-12b	GMC-12M/GMC-12
MMS-32H-6	4~6	100	65	25	MC-18	MC-18a/MC-18b	GMC-18
MMS-32H-8	5~8	100	65	10	MC-18	MC-18a/MC-18b	GMC-18
MMS-32H-10	6~10	100	65	10	MC-18	MC-18a/MC-18b	GMC-18
MMS-32H-13	9~13	100	65	10	MC-25	MC-22b/MC-25a	GMC-22
MMS-32H-17	11~17	100	30	10	MC-25	MC-22b/MC-25a	GMC-22
MMS-32H-22	14~22	100	30	10	MC-25	MC-22b/MC-25a	GMC-32
MMS-32H-26	18~26	100	30	10	MC-32	MC-32a	GMC-32
MMS-32H-32	22~32	100	30	10	MC-32	MC-32a	GMC-32
MMS-32H-40	28~40	100	30	10	-	MC-35a/MC-40a	-
63AF Rotary operation, standard interruption							
MMS-63S-10	6~10	100	50	10	MC-35	MC-50a	GMC-32
MMS-63S-13	9~13	100	50	10	MC-35	MC-50a	GMC-32
MMS-63S-17	11~17	100	40	10	MC-35	MC-50a	GMC-32
MMS-63S-22	14~22	100	40	10	MC-35	MC-50a	GMC-32
MMS-63S-26	18~26	100	40	10	MC-35	MC-50a	GMC-32
MMS-63S-32	22~32	100	40	10	MC-35	MC-50a	GMC-32
MMS-63S-40	28~40	100	40	10	MC-40	MC-50a	GMC-40
MMS-63S-50	34~50	100	40	10	MC-50	MC-50a	GMC-50
MMS-63S-63	45~63	100	40	10	MC-63	MC-65a	GMC-65
MMS-63S-65	47~65	100	40	10	-	MC-65a	-
63AF Rotary operation, High interruption							
MMS-63H-10	6~10	100	65	25	MC-35	MC-50a	GMC-32
MMS-63H-13	9~13	100	65	25	MC-35	MC-50a	GMC-32
MMS-63H-17	11~17	100	50	10	MC-35	MC-50a	GMC-32
MMS-63H-22	14~22	100	50	10	MC-35	MC-50a	GMC-32
MMS-63H-26	18~26	100	50	10	MC-35	MC-50a	GMC-32
MMS-63H-32	22~32	100	50	10	MC-35	MC-50a	GMC-32
MMS-63H-40	28~40	100	50	10	MC-40	MC-50a	GMC-40
MMS-63H-50	34~50	100	50	10	MC-50	MC-50a	GMC-50
MMS-63H-63	45~63	100	50	10	MC-63	MC-65a	GMC-65
MMS-63H-65	47~65	100	40	10	-	MC-65a	-
100AF Rotary operation, Standard interruption							
MMS-100S-17	11~17	100	50	10	MC-65	MC-75a	GMC-50
MMS-100S-22	14~22	100	50	10	MC-65	MC-75a	GMC-50
MMS-100S-26	18~26	100	50	10	MC-65	MC-75a	GMC-50
MMS-100S-32	22~32	100	50	10	MC-65	MC-75a	GMC-50
MMS-100S-40	28~40	100	50	10	MC-65	MC-75a	GMC-50
MMS-100S-50	34~50	100	50	10	MC-65	MC-75a	GMC-50
MMS-100S-63	45~63	100	40	10	MC-65	MC-75a	GMC-65
MMS-100S-75	55~75	100	40	10	MC-75	MC-75a	GMC-75
MMS-100S-90	70~90	100	40	10	MC-85	MC-85a	GMC-85
MMS-100S-100	80~100	100	40	10	MC-95	MC-100a	GMC-85
100AF Rotary operation, High interruption							
MMS-100H-17	11~17	100	65	25	MC-65	MC-75a	GMC-50
MMS-100H-22	14~22	100	65	20	MC-65	MC-75a	GMC-50
MMS-100H-26	18~26	100	65	20	MC-65	MC-75a	GMC-50
MMS-100H-32	22~32	100	65	20	MC-65	MC-75a	GMC-50
MMS-100H-40	28~40	100	65	20	MC-65	MC-75a	GMC-50
MMS-100H-50	34~50	100	65	20	MC-65	MC-75a	GMC-50
MMS-100H-63	45~63	100	50	10	MC-65	MC-75a	GMC-65
MMS-100H-75	55~75	100	50	10	MC-75	MC-75a	GMC-75
MMS-100H-90	70~90	100	50	10	MC-85	MC-85a	GMC-85
MMS-100H-100	80~100	100	50	10	MC-95	MC-100a	GMC-85

Contactors (18AF/22AF)

MC-6a-18a AC

1a or 1b

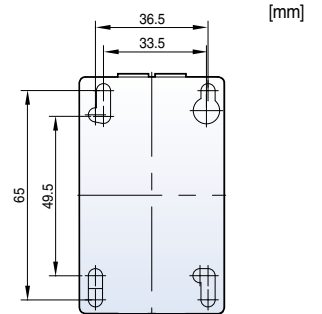
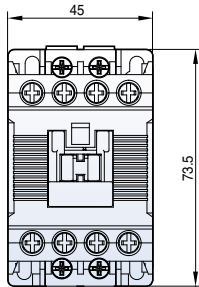

[mm]

0.3kg

MC-6a-18a DC

1a or 1b

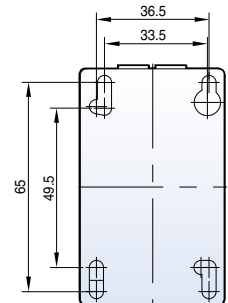
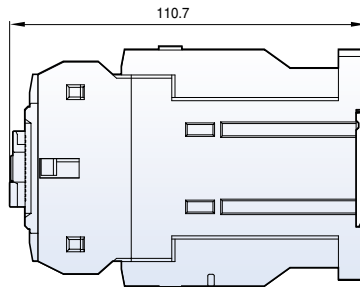
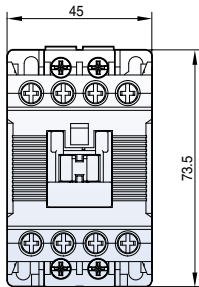

0.5kg

MC-9b-22b AC

1a1b

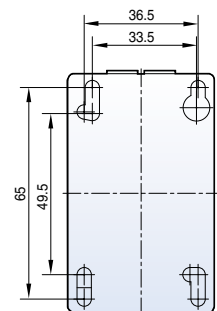
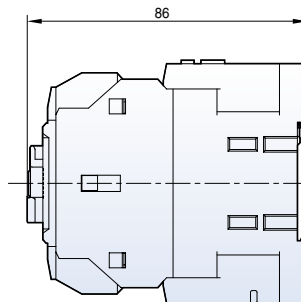
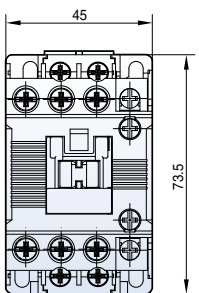

0.3kg

MC-9b-22b DC

1a1b

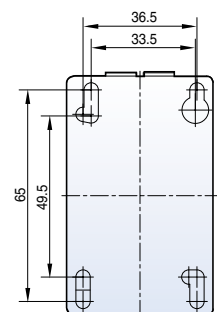
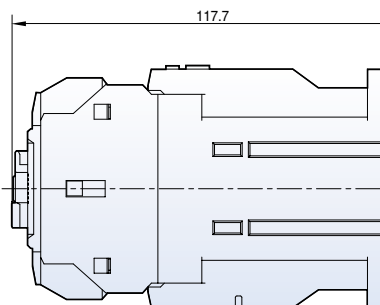
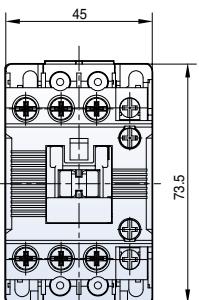

0.5kg

Contactors (40AF)

MC-32a-40a AC

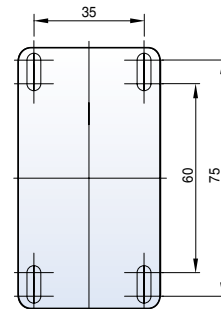
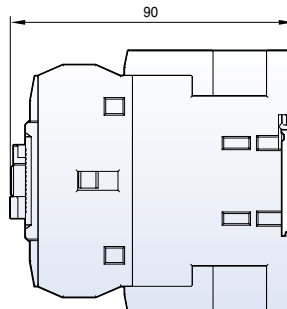
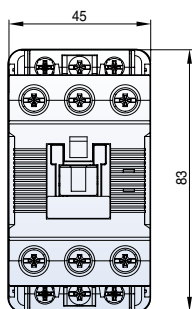

[mm]

0.4kg

MC-32a-40a DC

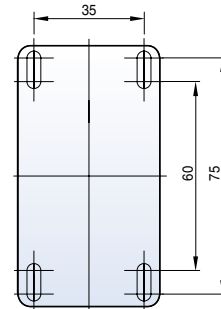
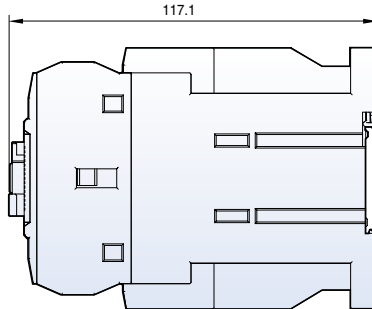
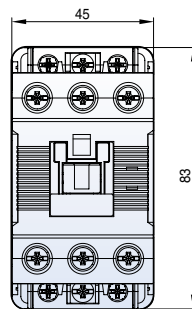

0.6kg

MC-32a-40a AC

2a2b

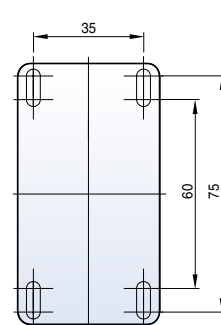
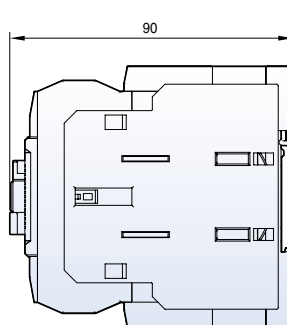
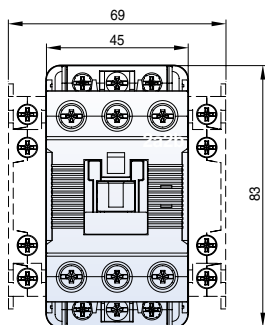

0.5kg

MC-32a-40a DC

2a2b

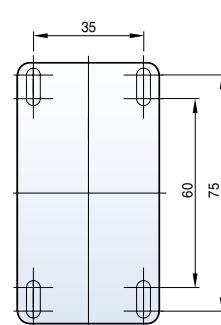
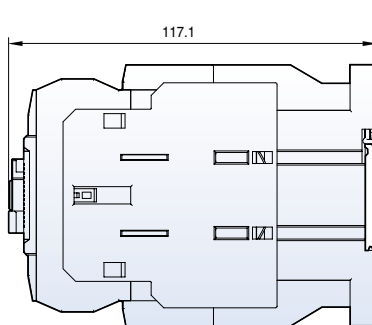
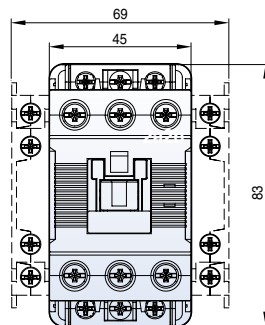

0.8kg

Contactors (65AF)

MC-50a-65a AC

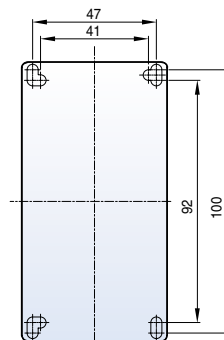
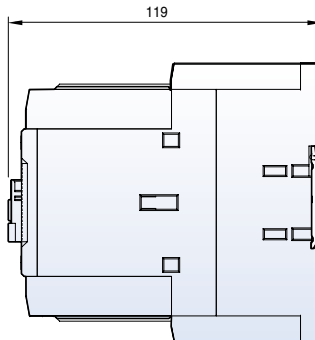
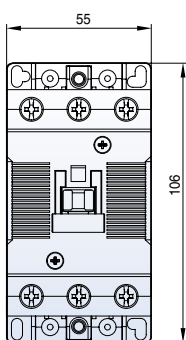

[mm]

0.9kg

MC-50a-65a DC

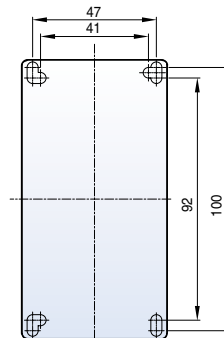
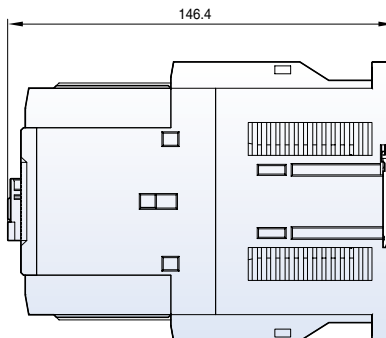
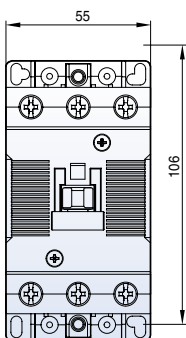

1.2kg

MC-50a-65a AC

2a2b

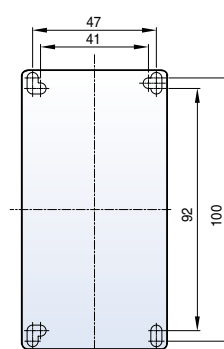
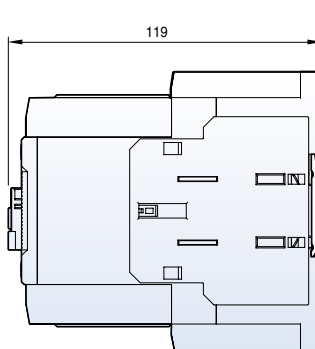
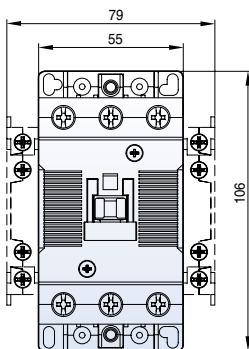

1kg

MC-50a-65a DC

2a2b

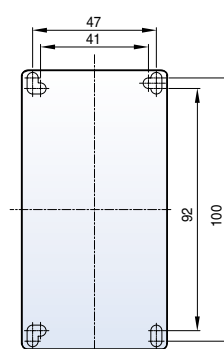
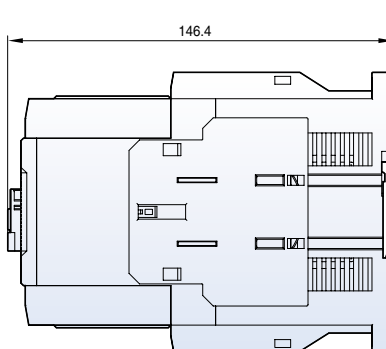
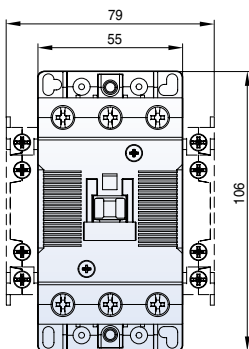

1.3kg

Contactors (100AF)

MC-75a~100a AC

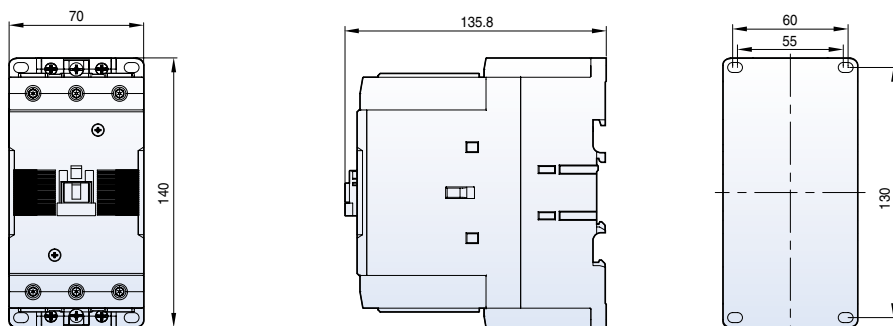

[mm]

1.8kg

MC-75a~100a DC

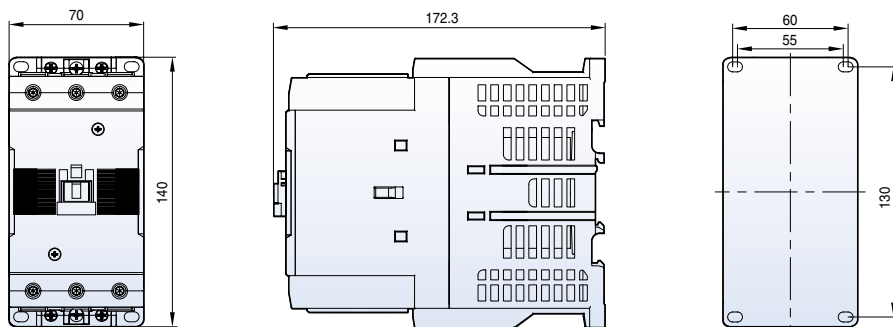

2.7kg

MC-75a~100a AC

2a2b

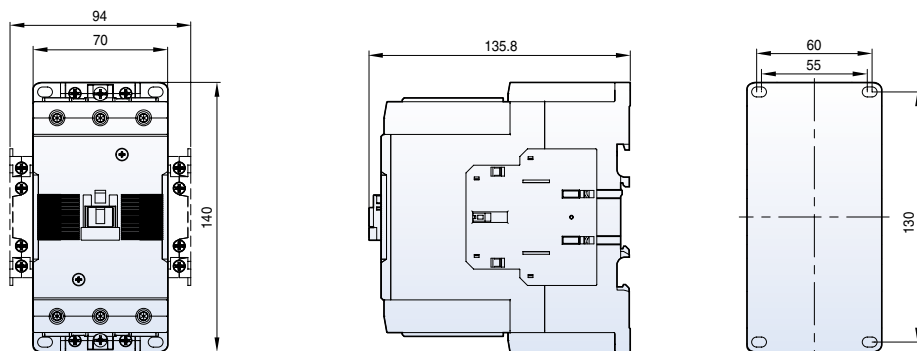

1.9kg

MC-75a~100a DC

2a2b

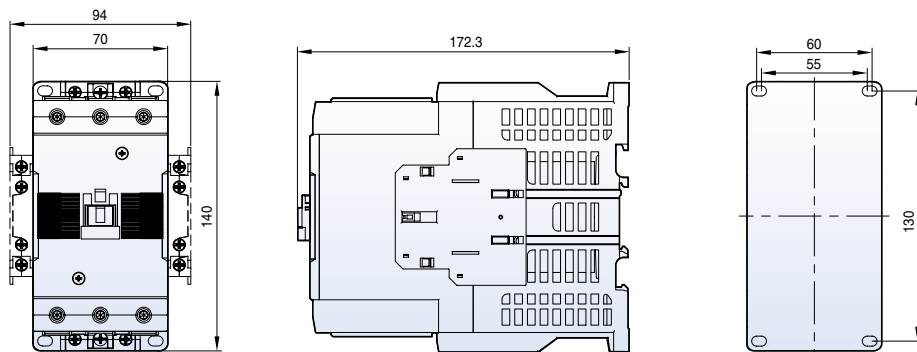

2.8kg

Contactors (150AF~800AF)

MC-130a

MC-150a

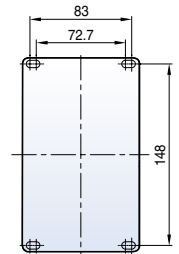
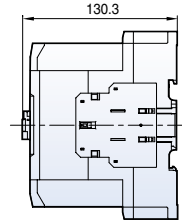
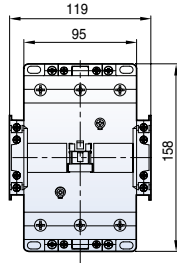

[mm]

2.4kg

MC-185a

MC-225a

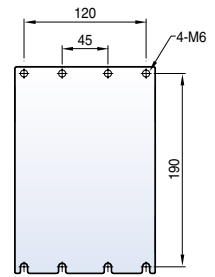
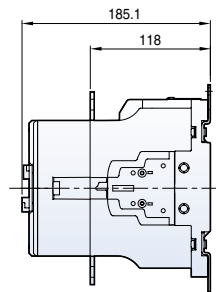
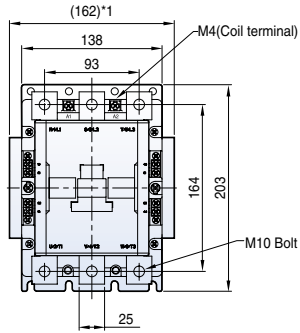

5.4kg

MC-265a

MC-330a

MC-400a

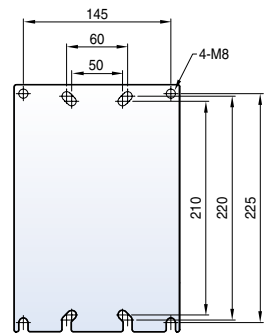
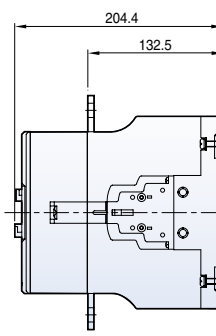
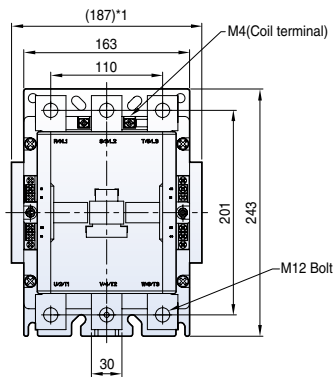

9.2kg

MC-500a

MC-630a

MC-800a

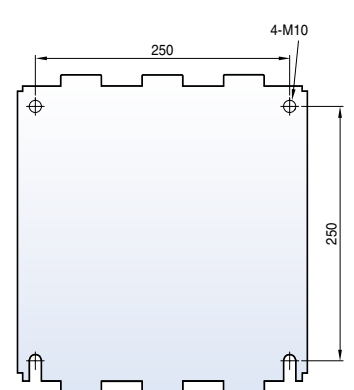
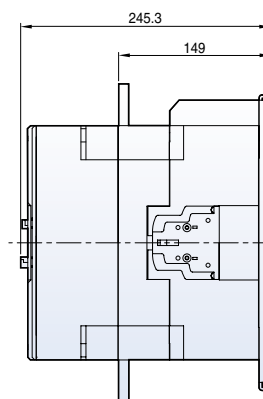
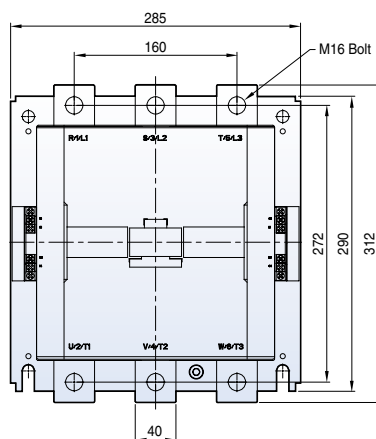

22.4kg

Motor starters (18AF~40AF)

MS-6a~18a

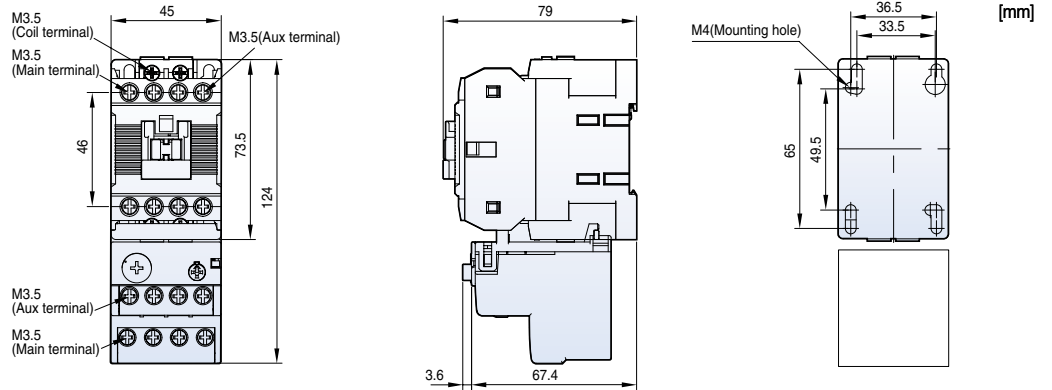

[mm]

0.5kg

MS-9b~22b

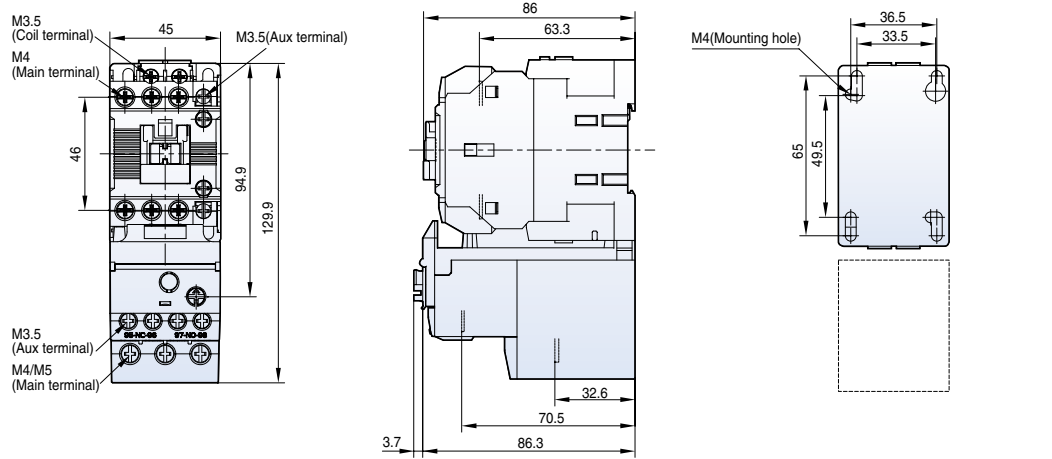

0.5kg

MS-32a~40a

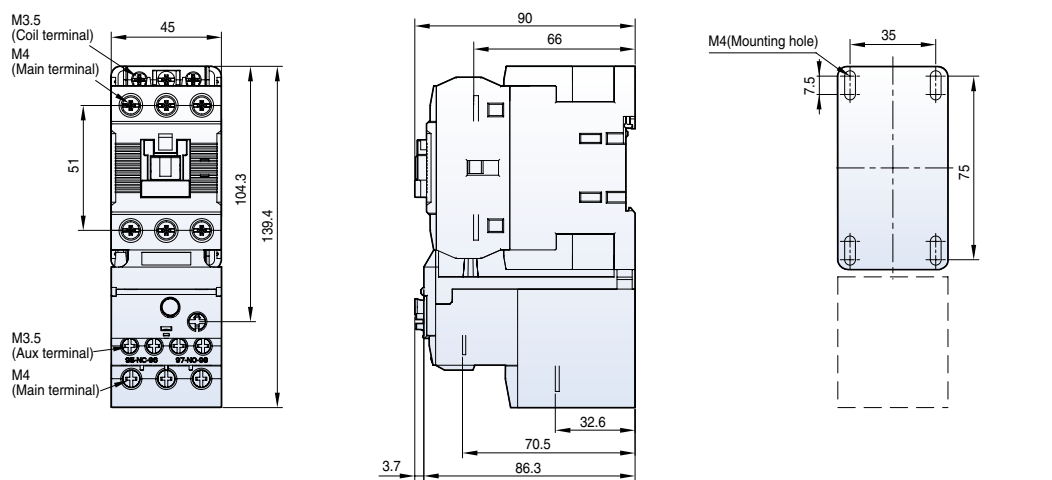

0.6kg

Motor starters (65AF~150AF)

MS-50a~65a

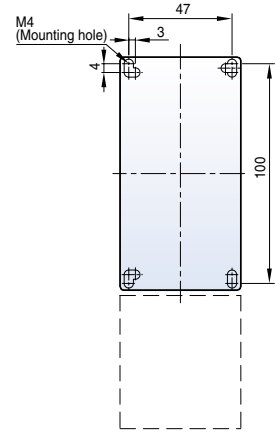
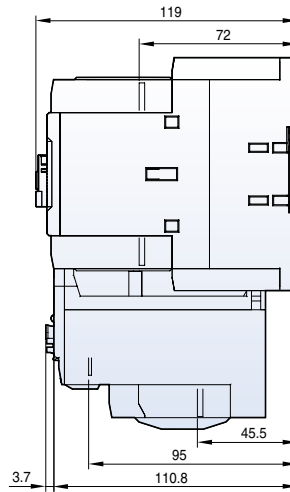
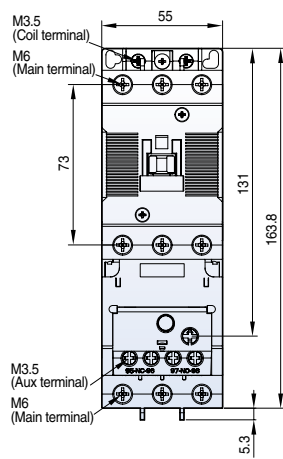

[mm]

1.3kg

MS-75a~100a

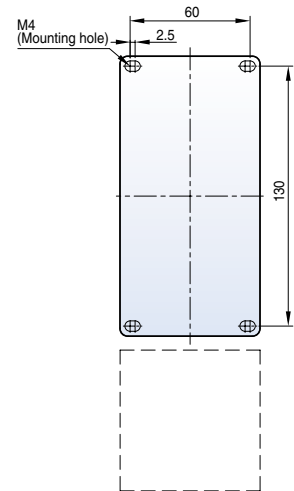
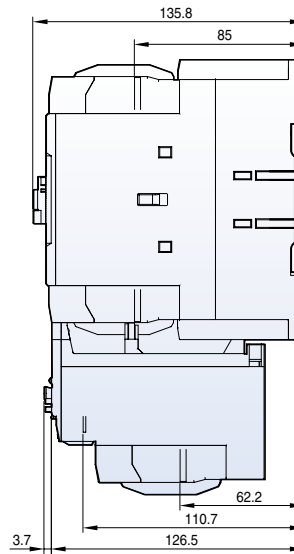
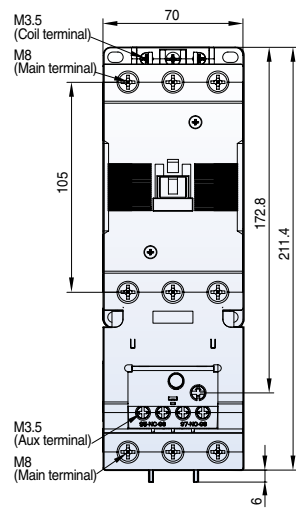

2.3kg

MS-130a

MS-150a

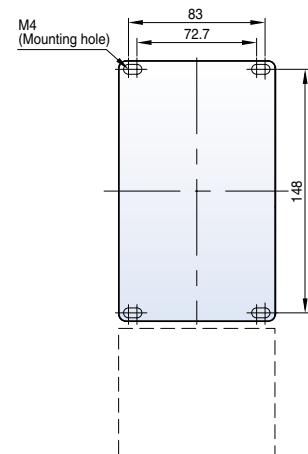
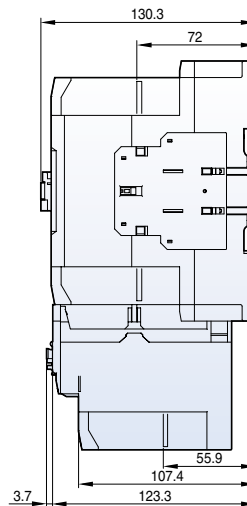
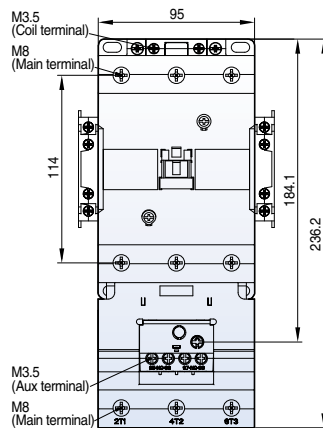

2.9kg

Motor starters (185AF~800AF)

- MS-185a
- MS-225a

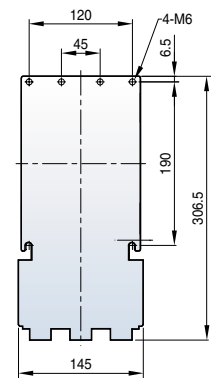
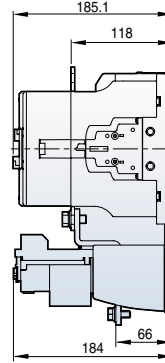
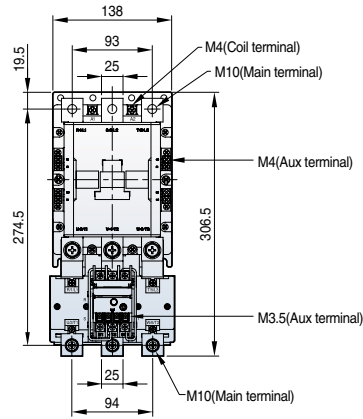

[mm]

7.9kg

- MS-265a
- MS-330a
- MS-400a

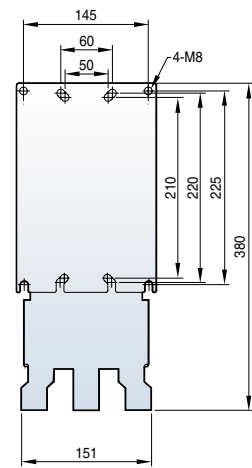
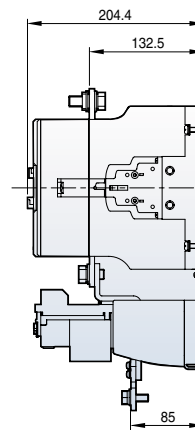
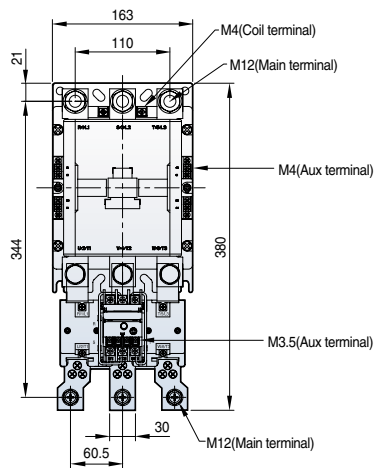

11.8kg

- MS-500a
- MS-630a
- MS-800a

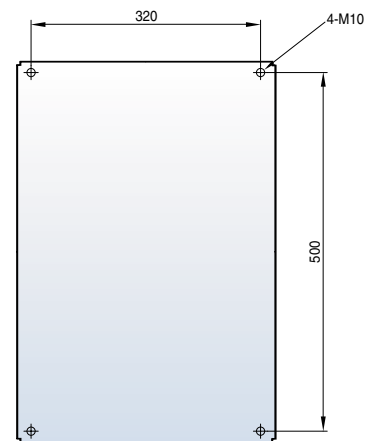
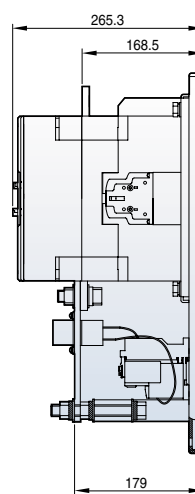
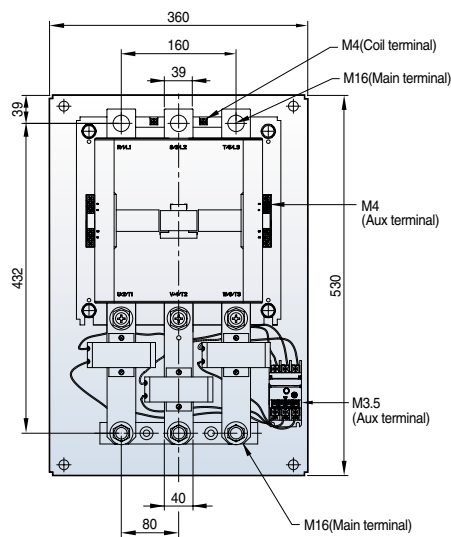

28kg

Reversing contactors and starters (18AF)

[mm]

MC-6aR-18aR AC

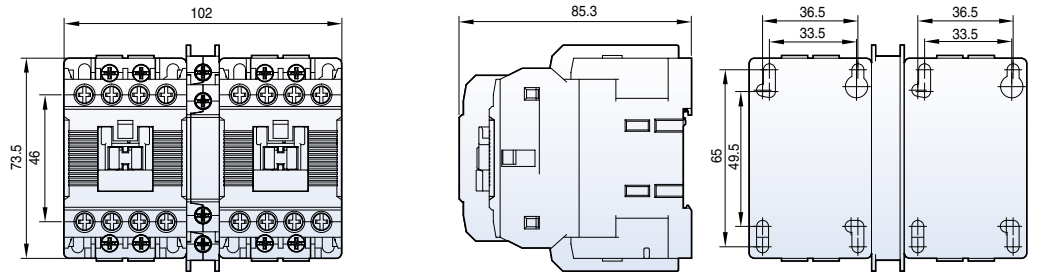

0.7kg

MC-6aR-18aR DC

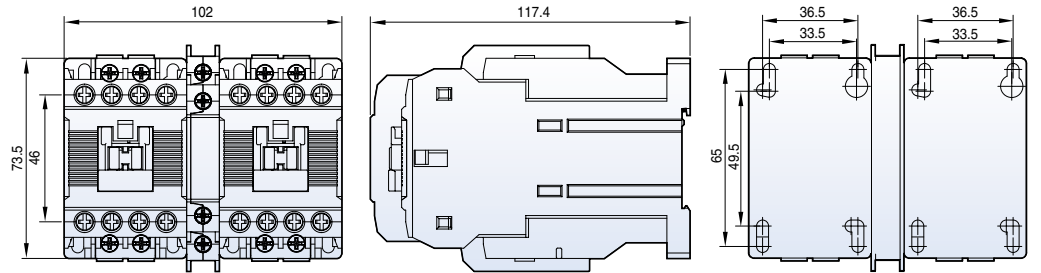

1kg

MS-6aR-18aR AC

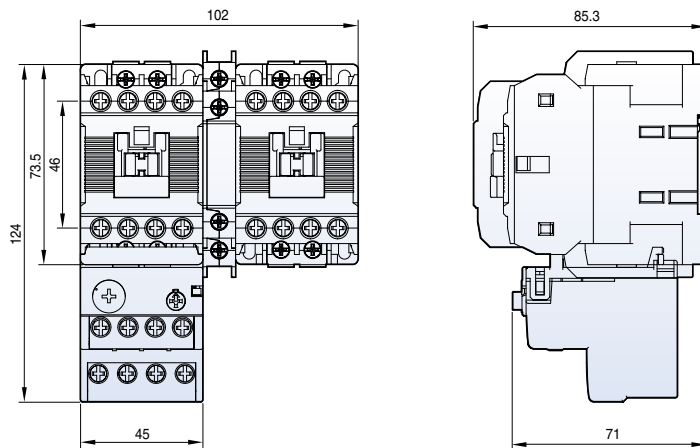

0.9kg

Reversing contactors and starters (22AF)

MC-9bR-22bR AC

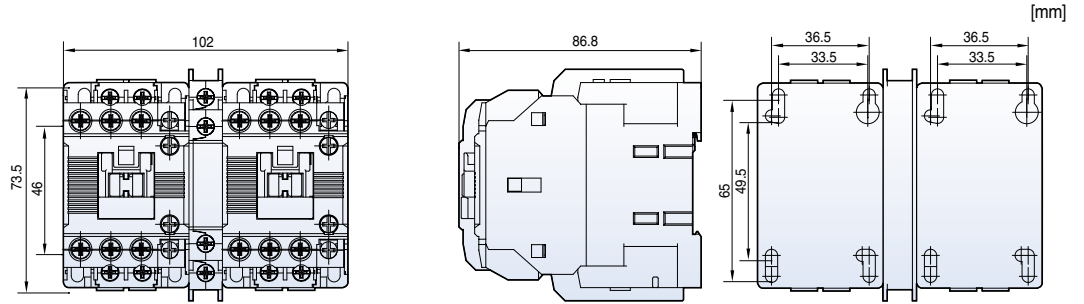

0.7kg

MC-9bR-22bR DC

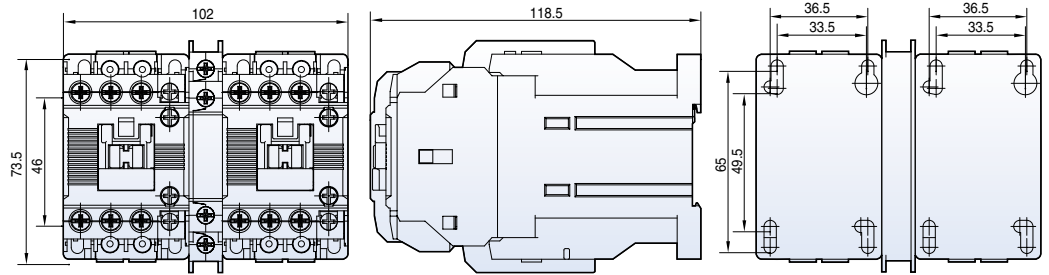

1.1kg

MS-9bR-22bR AC

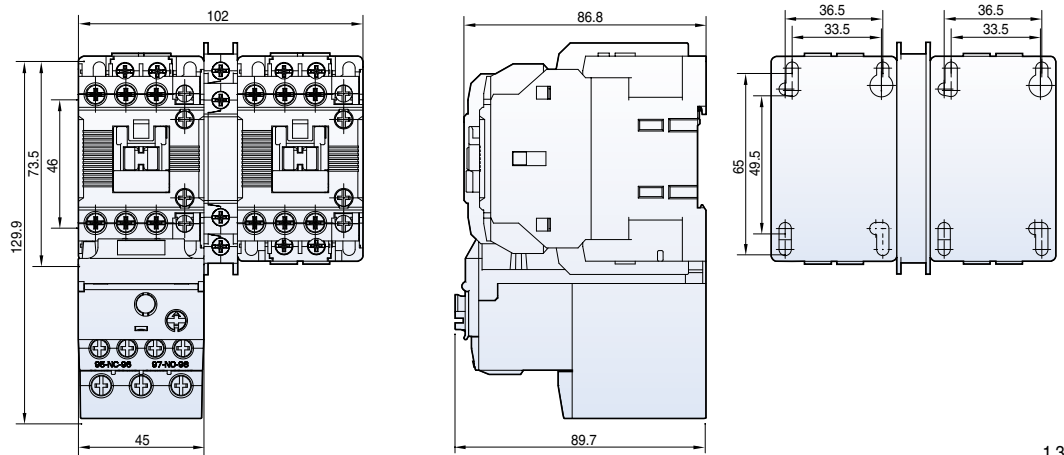

1.3kg

Reversing contactors and starters (40AF)

MC-32aR~40aR AC

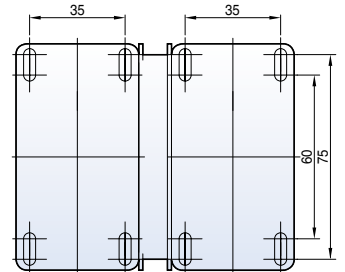
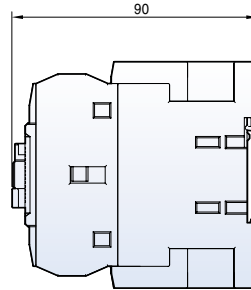
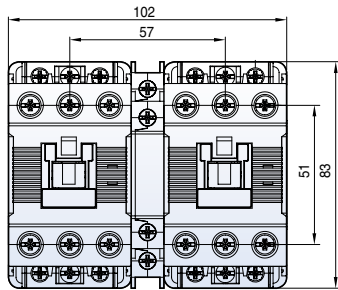

[mm]

0.9kg

MC-32aR~40aR DC

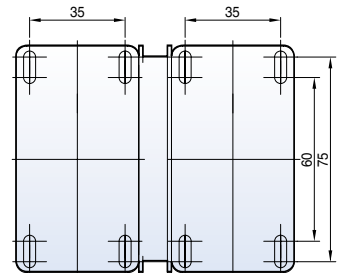
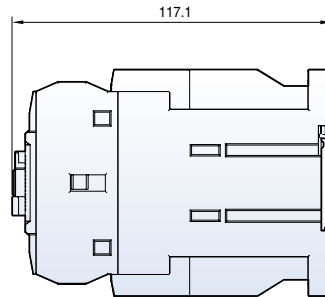
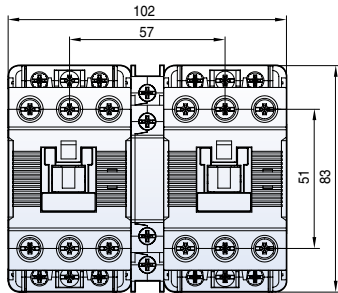

1.4kg

MS-32aR~40aR AC

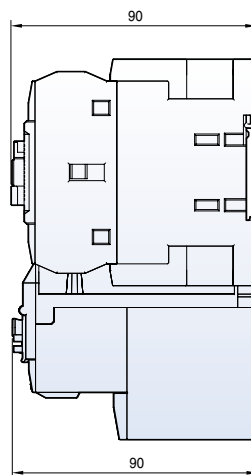
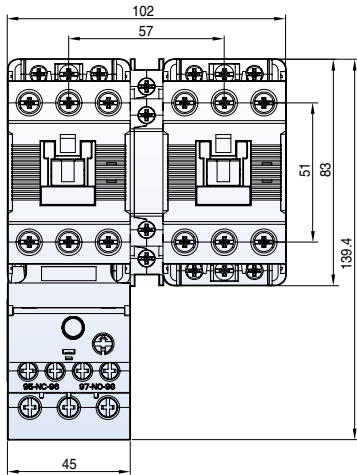

1.1kg

Reversing contactors and starters (65AF)

MC-50aR-65aR AC

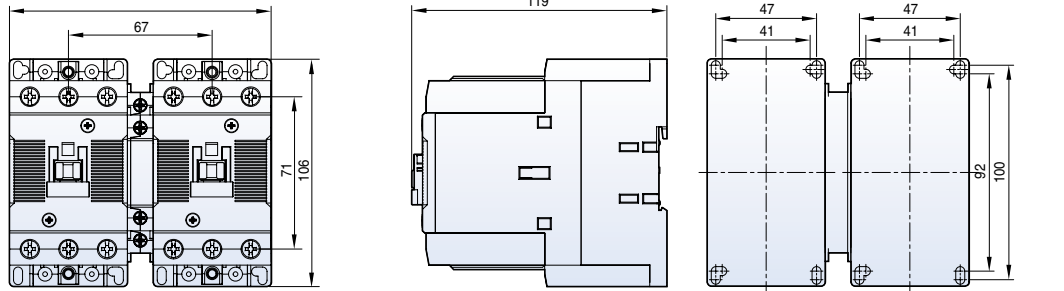

1.8kg

MC-50aR-65aR DC

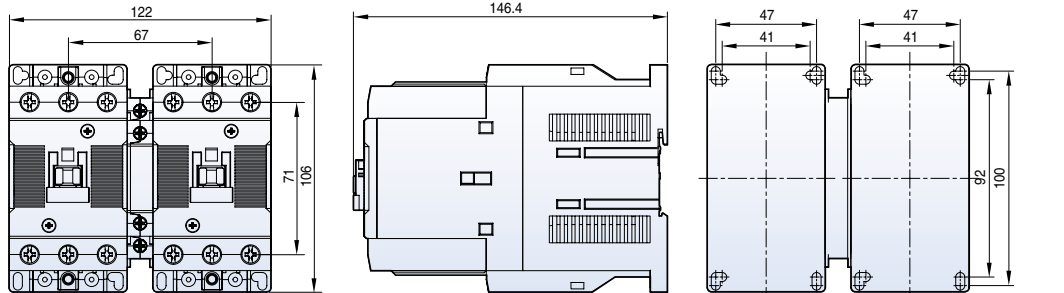

2.4kg

MS-50aR-65aR AC

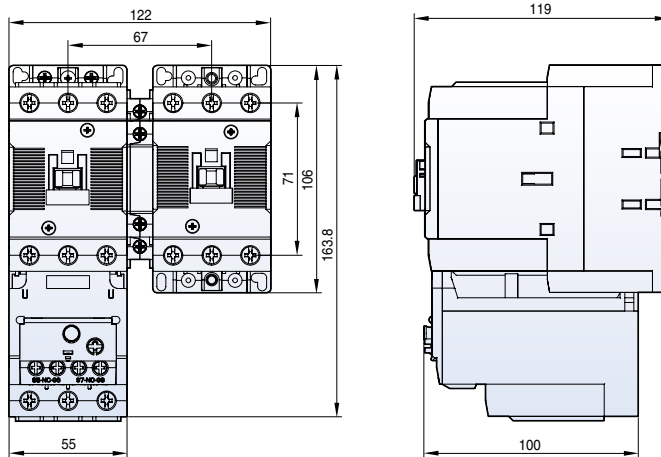

1.9kg

Reversing contactors and starters (100AF)

MC-75aR-100aR AC

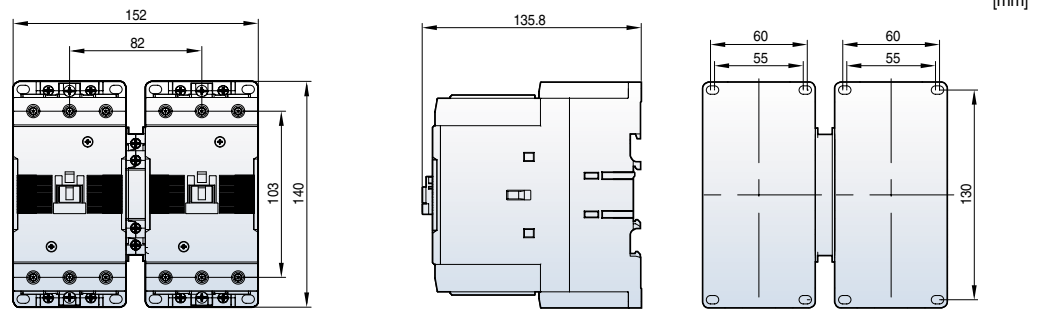

[mm]

3.3kg

MC-75aR-100aR DC

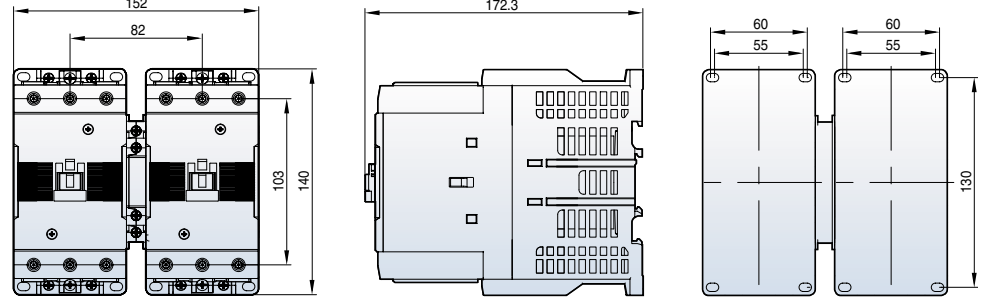

5.2kg

MS-75aR-100aR AC

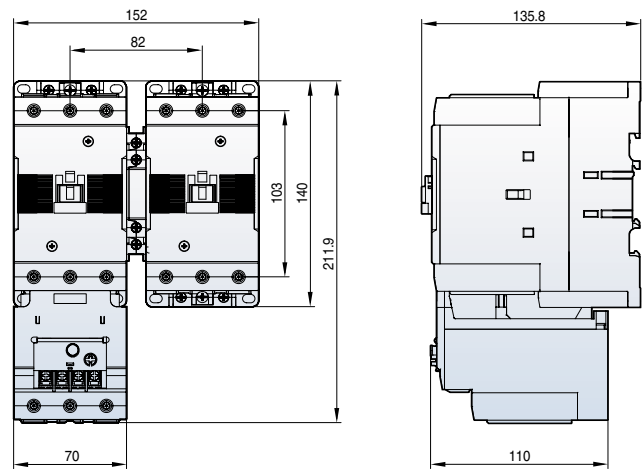

3.8kg

Reversing contactors and starters (150~800AF)

MC-130aR
MC-150aR

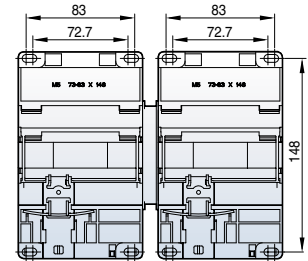
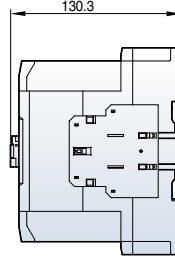
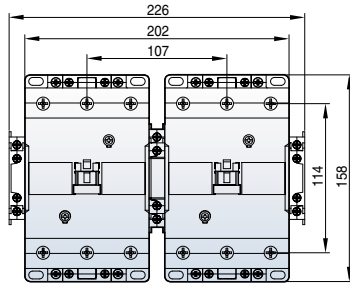

[mm]

4.3kg

MC-185aR
MC-225aR

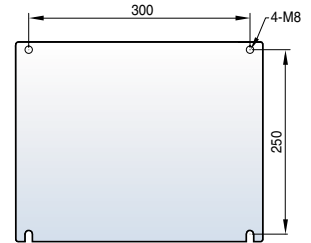
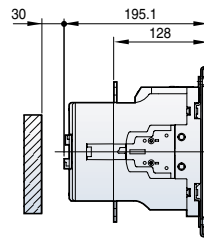
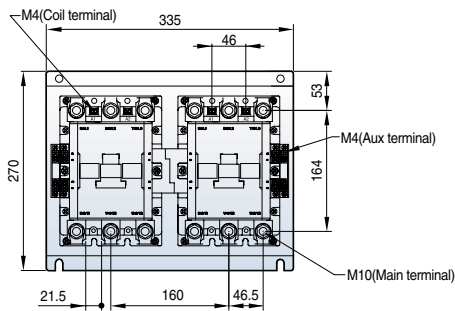

12.9kg

MC-265aR
MC-330aR
MC-400aR

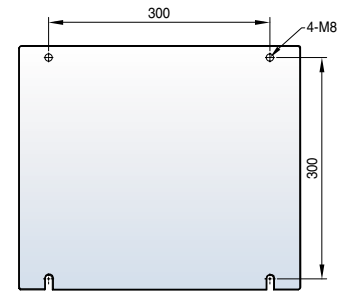
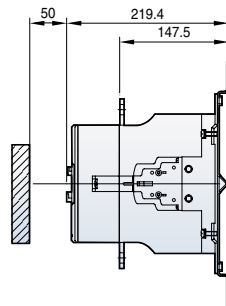
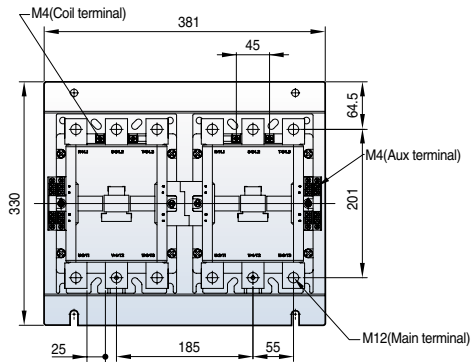

21.4kg

MC-500aR
MC-630aR
MC-800aR

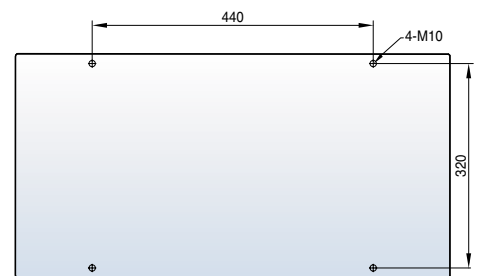
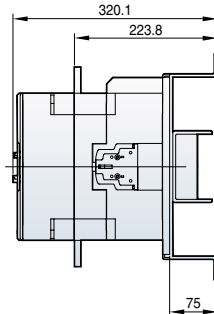
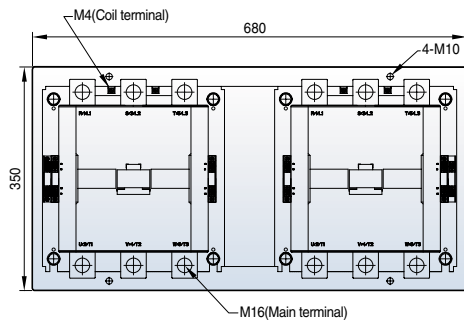

60kg

Reversing contactors and starters (150~400AF)

Metasol

[mm]

- MS-130aR AC
- MS-150aR AC

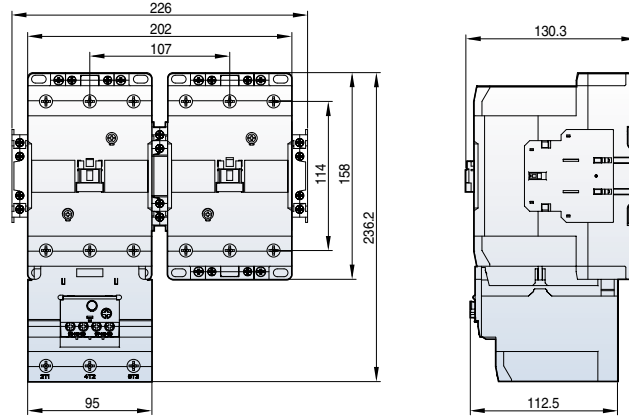

5kg

- MS-185aR AC
- MS-225aR AC

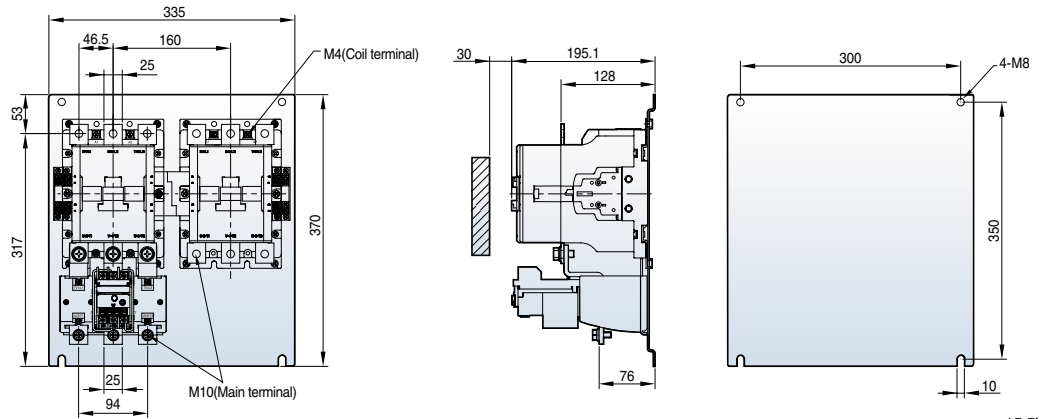

15.5kg

- MS-265aR DC
- MS-330aR DC
- MS-400aR DC

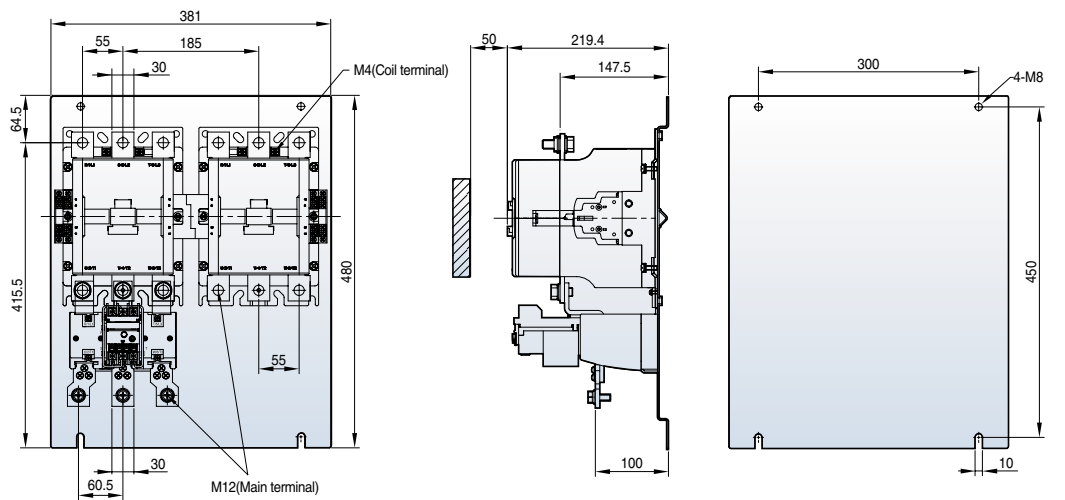

23kg

Overload relays

MT-12

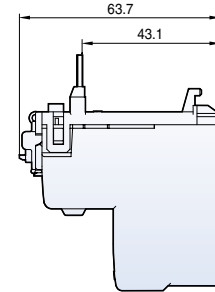
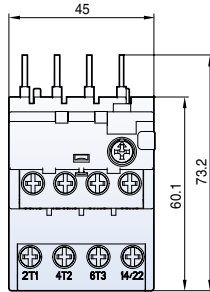

[mm]

100g

MT-32

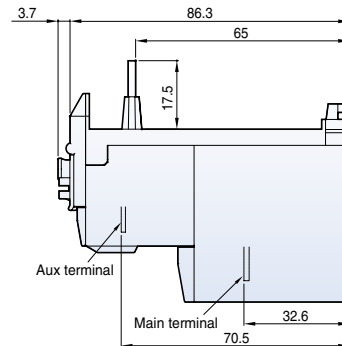
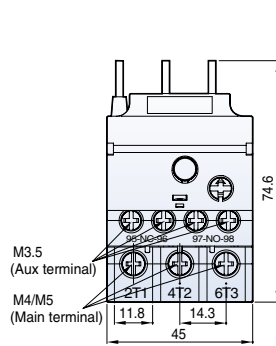

167g

MT-63

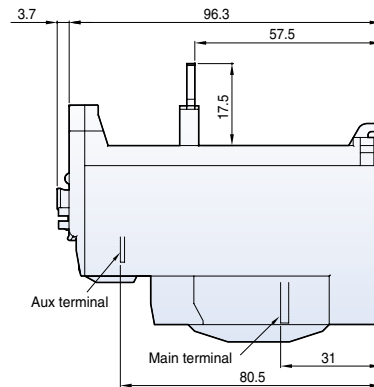
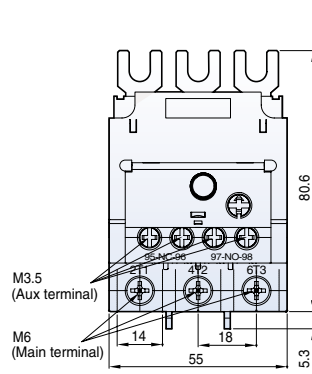

303g

MT-95

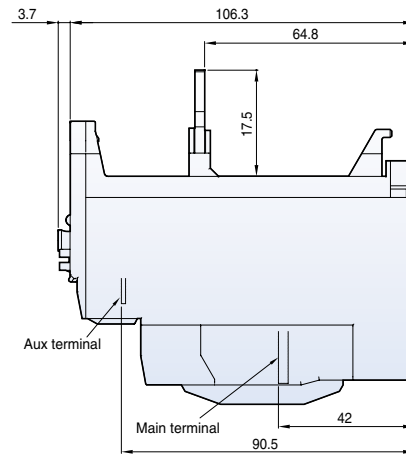
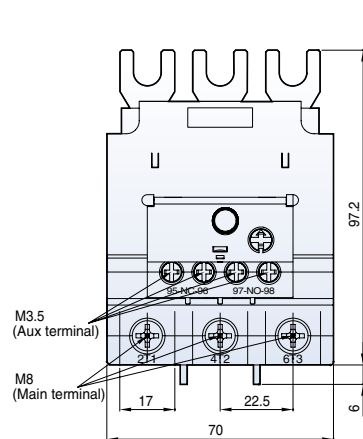

474g

Overload relays

Metasol

MT-150

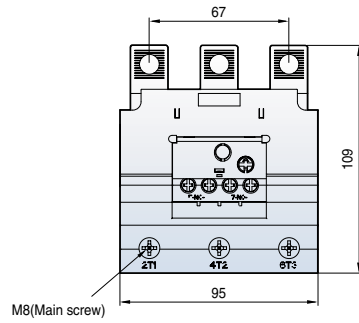

[mm]

0.7kg

MT-225

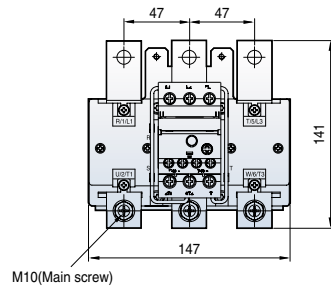

2.5kg

MT-400

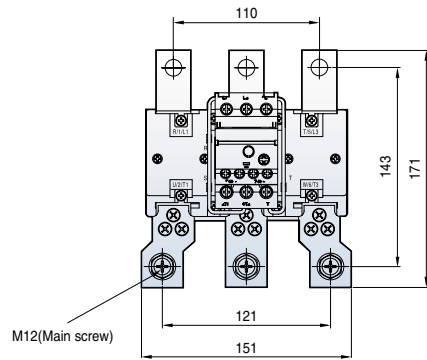

2.6kg

MT-800

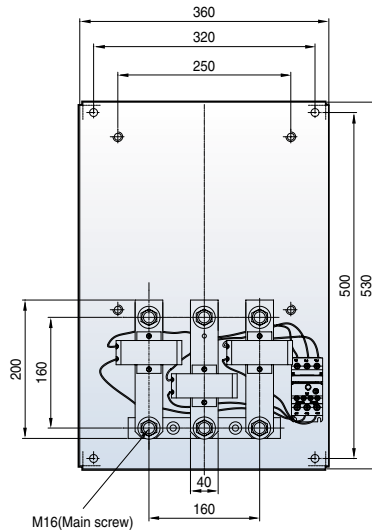

11.5kg

Overload relays (Separate mount)

UZ-32

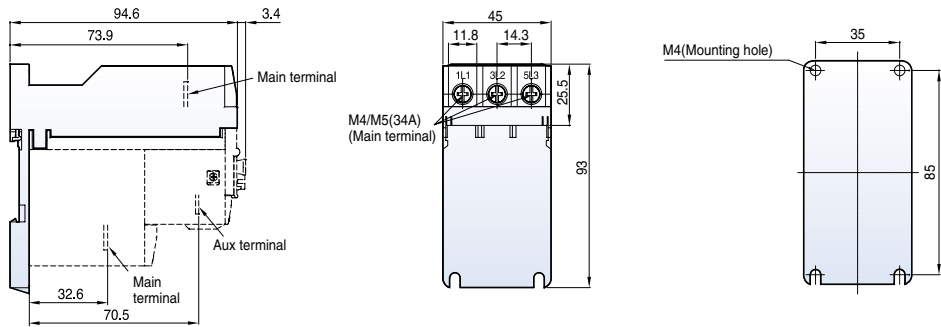

[mm]

68g

UZ-63

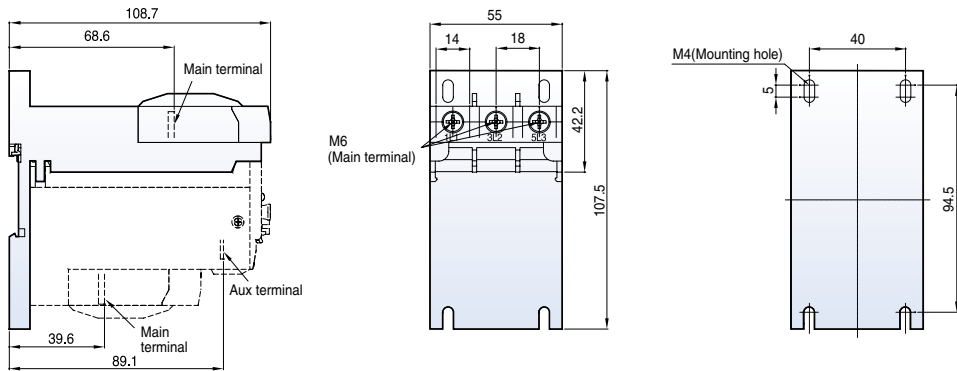

134g

UZ-95

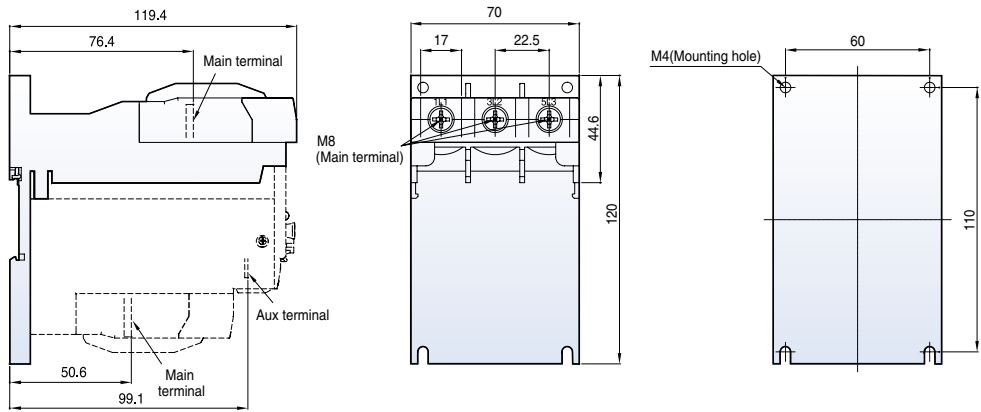

230g

UZ-150

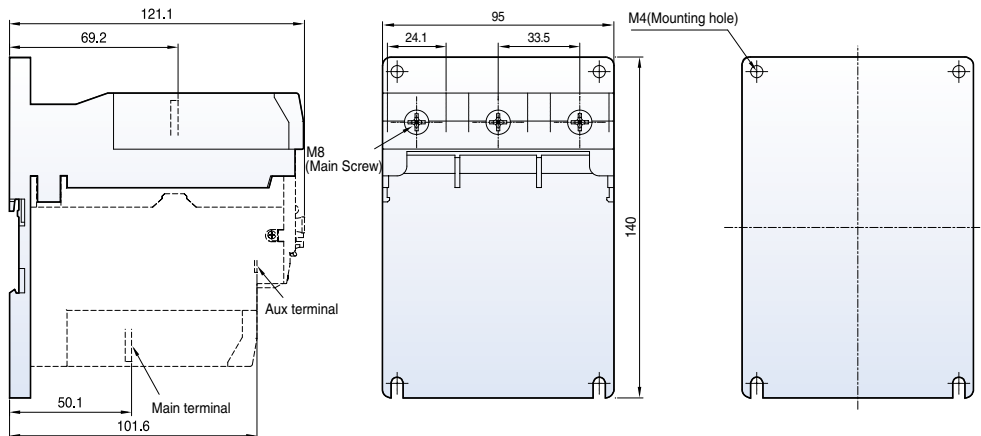

284g

Contact arrangement

Contactors

MC-6a~18a

1a

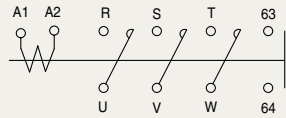

1b

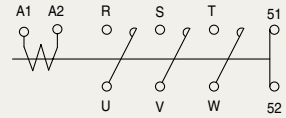

MC-9b~22b

1a1b

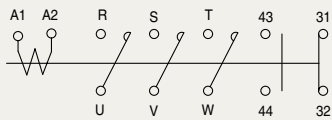

MC-32a~150a

2a2b

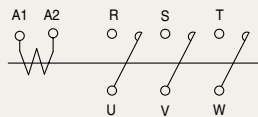
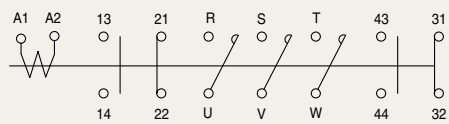

Motor starters

MS-6a~150a

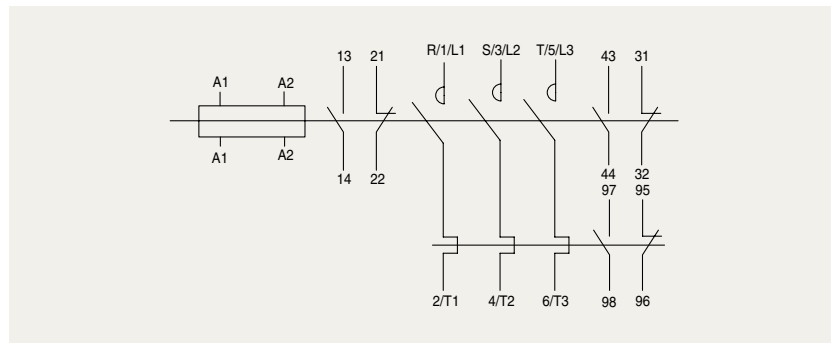
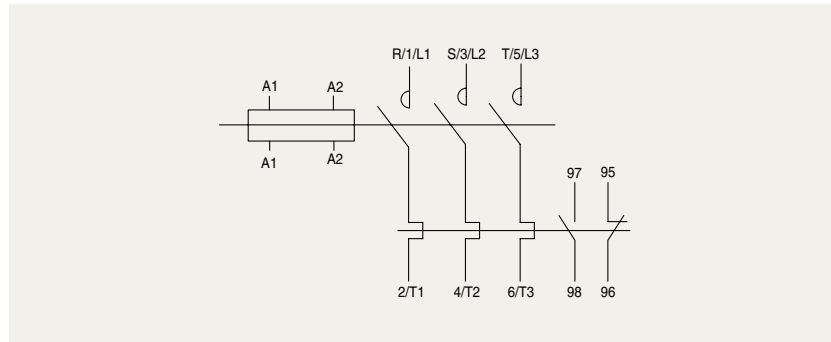

MS-185a~800a

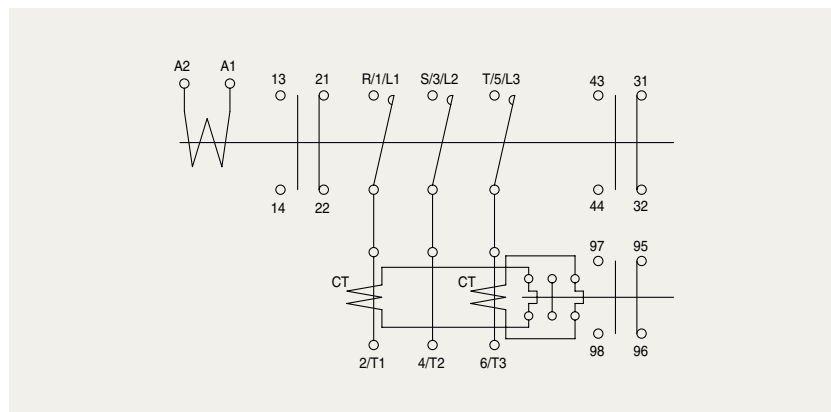

Reversing contactors

MC-6aR~150aR

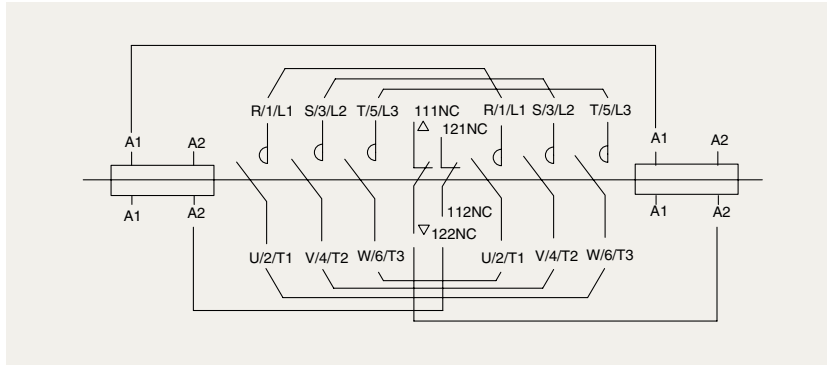

MS-6aR~150aR

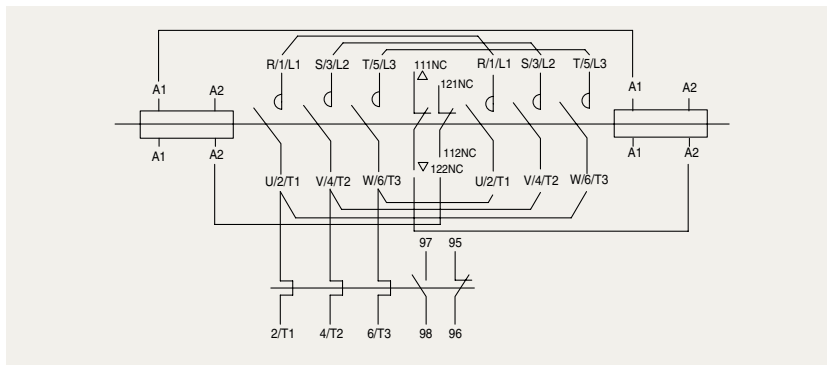

MC-185aR~800aR

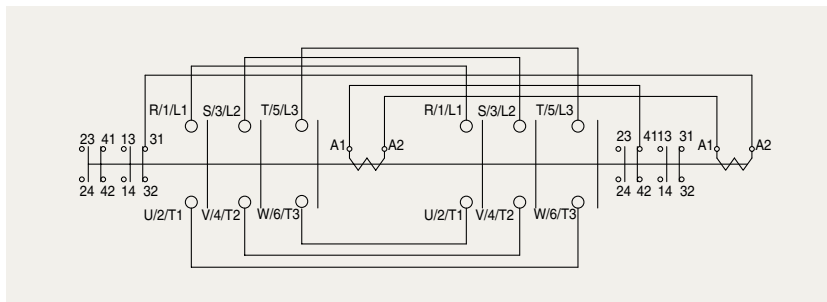

MS-185aR~400aR

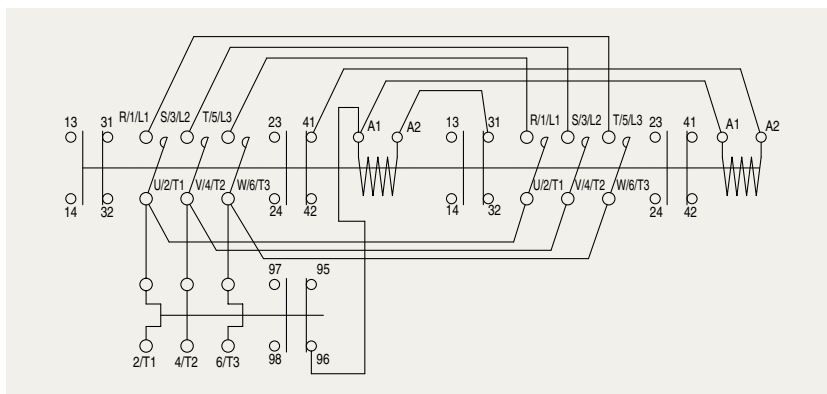



Metasol MC 4pole



Contents :

Contactor

Overview	108
Table of specifications	110
Dimension	114



Metasol Series completion

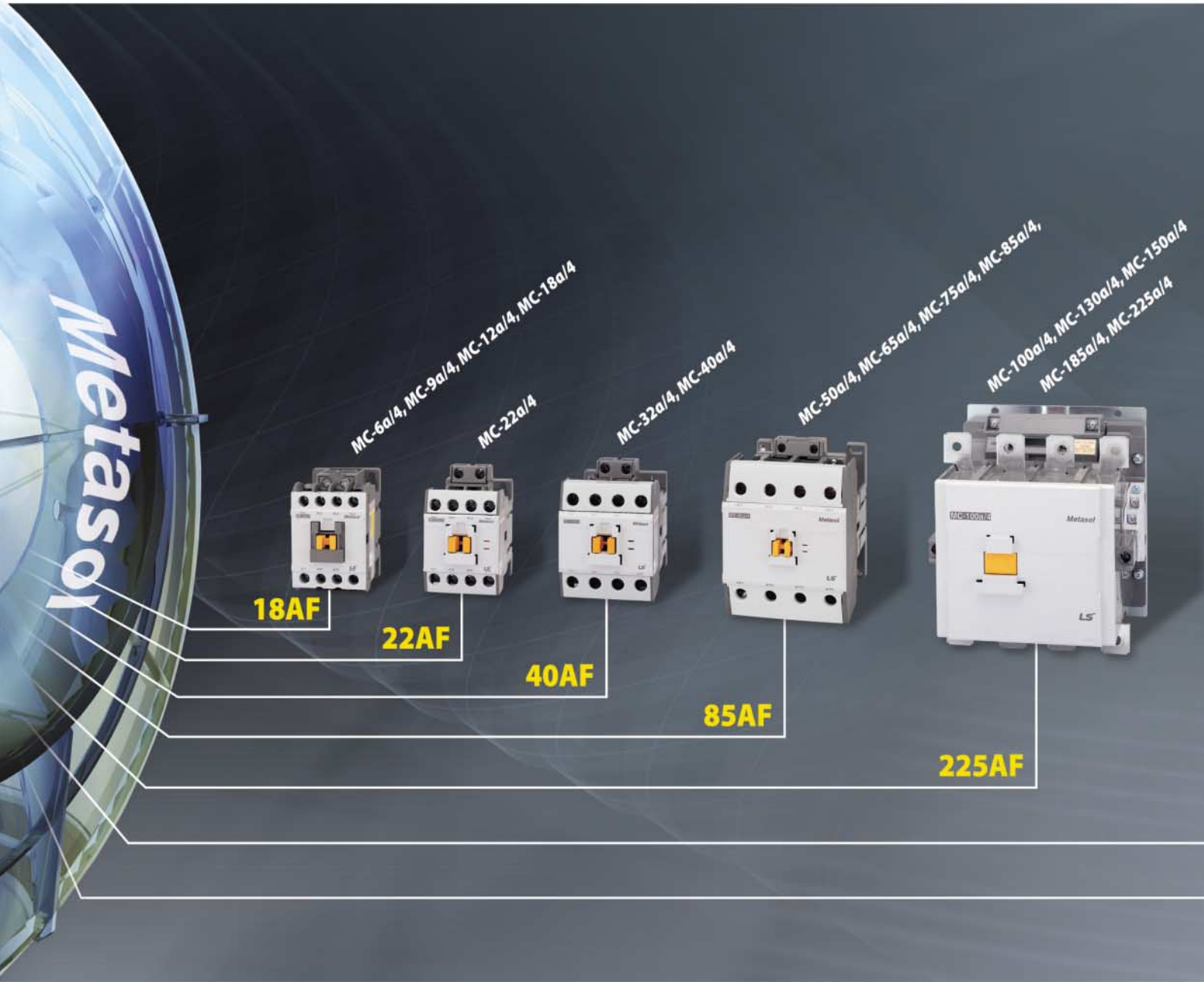

More Safe,
More Valuable



Contactors & Overload Relays



400AF

MC-265a/4, MC-330a/4, MC-400a/4



800AF

MC-500a/4, MC-630a/4, MC-800a/4

- *Advanced technology & Expert solution*
- *Offering economical solution with compact size & easy connection*
- *Perfect system with peripheral devices.*
- *Environment friendly product: complies with International environment standard RoHS.*

Table of specifications

MC type Magnetic Contactors



Frame size			
Type	Screw clamp terminal		
Number of poles	4pole		
Rated operational voltage (Ue)	690V		
Rated insulation voltage (Ui)	690V		
Rated frequency	50/60Hz		
Rated impulse withstand voltage, Uimp	6kV		
Maximum operating rate in operating cycles per hour(AC1)	1800 operations per hour		
Durability	Mechanical		
	15 mil. Operations		
Current and Power	AC-1	Thermal current	A
		200/240V	kW
		380/400V	kW
			A
	500/550V	kW	
			A
		690V	kW
		A	
UL rating (50/60Hz)	Continuous current		A
	Single Phase	110~120V	HP
		220~240V	HP
	200~208V	HP	
		220~240V	HP
		440~480V	HP
	550~600V	HP	
		HP	
Size and weight	NEMA Size		
	AC	Weight	kg
	Control	Size(W × H × D)	mm
	DC	Weight	kg
	Control	Size(W × H × D)	mm
Auxiliary(standard)			
Auxiliary	Side Mount		
	Front Mount		



18AF				
MC-6a/4	MC-9a/4	MC-12a/4	MC-18a/4	
●				
4pole				
690V				
690V				
50/60Hz				
6kV				
1800 operations per hour				
15 mil. Operations				
0.5 mil. Operations		0.8 mil. Operations		
25	25	25	40	
9	9	9	15	
25	25	25	40	
17	17	17	27	
25	25	25	40	
21	21	21	35	
25	25	25	40	
27	27	27	44	
25	25	25	40	
25	25	25	32	
0.5	0.5	0.75	1	
1.5	1.5	2	3	
2	2	3	5	
3	3	5	7.5	
5	5	7.5	10	
7.5	7.5	10	15	
00	00	0	0	
0.33				
45 × 73.5 × 79				
0.5				
45 × 73.5 × 110.7				
-				
UA-1				
AU-2, AU-4				



22AF	
MC-22a/4	
●	
4pole	
690V	
690V	
50/60Hz	
6kV	
1800 operations	
15 mil. Operations	
1 mil. Operations	
40	
15	
40	
27	
40	
35	
40	
44	
40	
32	
2	
3	
7.5	
7.5	
10	
15	
1	
0.4	
47.2 × 80 × 86.8	
0.5	
47.2 × 80 × 113.2	
-	
AU-1	
AU-2, AU-4	

40AF	
MC-32a/4	MC-40a/4
●	
4pole	
690V	
690V	
50/60Hz	
6kV	
1800 operations per hour	
15 mil. Operations	
1 mil. Operations	
50	60
18	22
50	60
35	42
50	60
43	52
50	60
55	66
50	60
45	50
2	3
5	5
7.5	10
10	10
20	25
20	25
1	1
0.59	
59 × 83.5 × 94.5	
0.7	
59 × 83.5 × 121	
-	
AU-1	

85AF			
MC-50a/4	MC-65a/4	MC-75a/4	MC-85a/4
●			
4pole			
690V			
1000V			
50/60Hz			
8kV			
1800 operations per hour			
12 mil. Operations			
1 mil. Operations			
80	100	110	135
30	37	41	51
80	100	110	135
56	70	76	95
80	100	110	135
70	88	97	120
80	100	110	135
88	110	120	150
80	100	110	135
70	80	90	100
3	5	5	7.5
7.5	10	15	15
10	15	20	25
15	20	25	30
30	40	50	50
30	40	50	50
2	2	2	3
1.2			
91 × 123.5 × 117.8			
1.29			
91 × 123.5 × 117.8			
-			
AU-1			
AU-2, AU-4			

Table of specifications

MC type Magnetic Contactors



Frame size			
Type	Screw clamp terminal		
Number of poles	4pole		
Rated operational voltage (Ue)	690V		
Rated insulation voltage (Ui)	1000V		
Rated frequency	50/60Hz		
Rated impulse withstand voltage, Uimp	8kV		
Maximum operating rate in operating cycles per hour(AC1)	1200 operations per hour		
Durability	Mechanical		
	15 mil. Operations		
Current and Power	Electrical		
Current and Power	AC-1	Thermal current	A
		200/240V	kW
		380/400V	kW
			A
		500/550V	kW
			A
	690V	kW	
		A	
UL rating (50/60Hz)	Continuous current		A
	Single Phase	110~120V	HP
		220~240V	HP
		200~208V	HP
	Three Phase	220~240V	HP
		440~480V	HP
		550~600V	HP
NEMA Size			
Size and weight	AC Control	Weight	kg
		Size(W × H × D)	mm
	DC Control	Weight	kg
		Size(W × H × D)	mm



225AF				
MC-100a/4	MC-130a/4	MC-150a/4	MC-185a/4	MC-225a/4
●				
4pole				
690V				
1000V				
50/60Hz				
8kV				
1200 operations per hour				
15 mil. Operations				
0.8 mil. Operations				
160	165	250	300	330
57	60	76	87	100
150	155	200	230	260
106	110	142	165	185
150	155	200	230	260
132	137	180	205	230
150	155	200	230	260
165	170	225	255	290
150	155	200	230	260
160	160	210	230	275
7.5	10	15	15	15
15	20	25	30	40
30	40	40	60	60
30	40	50	60	75
60	75	100	125	150
60	75	100	125	150
3	3	4	4	4
5.6				
175 × 203 × 185				
2a2b				
AU-100				
-				

* - FLA = 722 A, LRA = 5618 A
 ** - FLA = 566 A, LRA = 4495 A



400AF

MC-265a/4	MC-330a/4	MC-400a/4
●		
4pole		
690V		
1000V		
50/60Hz		
8kV		
1200 operations per hour		
15 mil. Operations		
0.5 mil. Operations		
360	420	500
115	135	160
300	350	420
215	250	300
300	350	420
265	315	375
300	350	420
335	390	470
300	350	420
300	350	450
-	-	-
-	-	-
75	100	125
100	100	150
200	200	300
200	200	300
5	5	5

9.9
206 × 243 × 205

2a2b

AU-100
-

800AF

MC-500a/4	MC-630a/4	MC-800a/4
●		
4pole		
690V		
1000V		
50/60Hz		
8kV		
1200 operations per hour		
12 mil. Operations		
0.5 mil. Operations		
630	750	900
245	255	310
630	660	800
450	470	570
630	660	800
560	590	710
630	660	800
710	740	900
630	660	800
580	660	900
-	-	-
-	-	-
150	200	200
200	250	300
400	500	600 *
400	500	600 **
6	6	7

26.3
346 × 310 × 244

2a2b

AU-100
-

Contactors (MC-6a/4~22a/4)

MC-6a/4-18a/4 AC

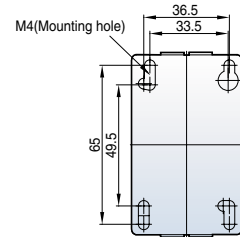
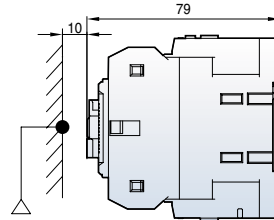
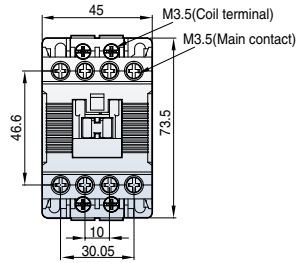

[mm]

0.3kg

MC-6a/4-18a/4 DC

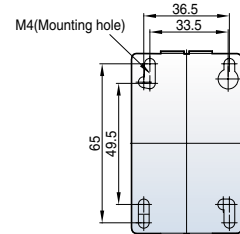
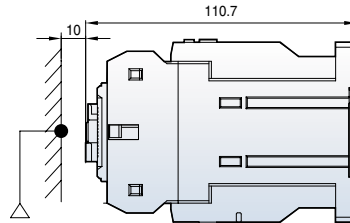
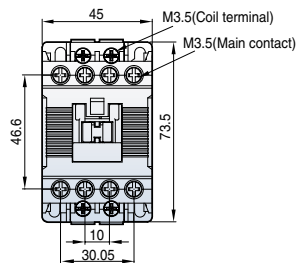

0.45kg

MC-22a/4 AC

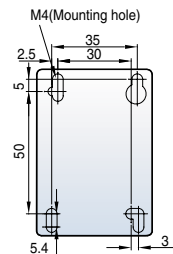
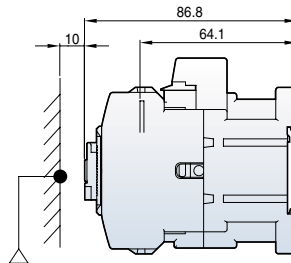
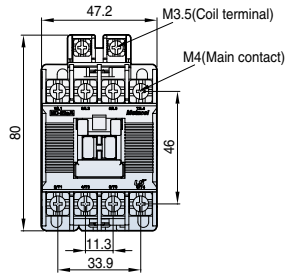

0.4kg

MC-22a/4 DC

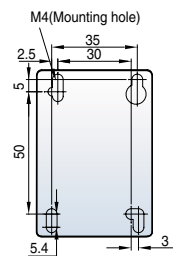
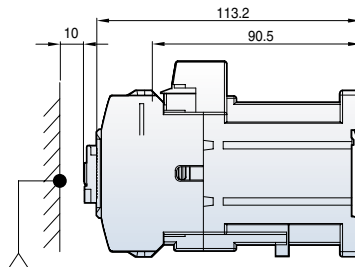
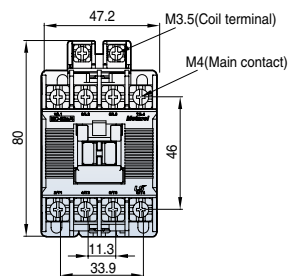

0.5kg

Contactors (MC-32a/4~85a/4)

MC-32a/4~40a/4 AC

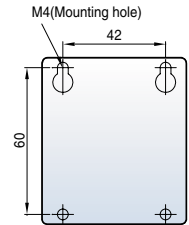
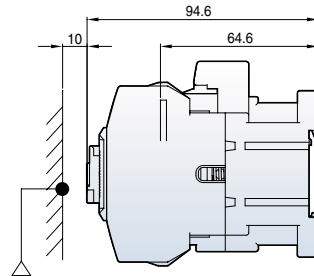
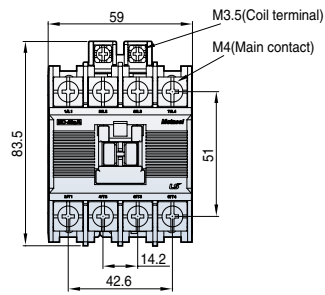

[mm]

0.59kg

MC-32a/4~40a/4 DC

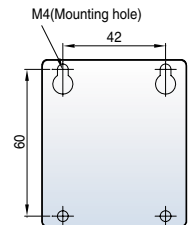
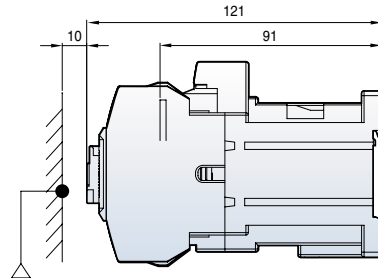
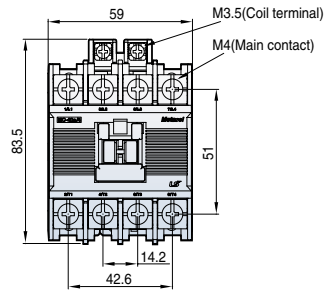

0.7kg

MC-50a/4~85a/4 AC

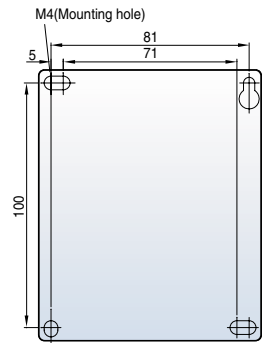
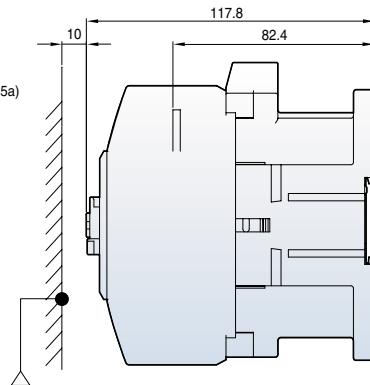
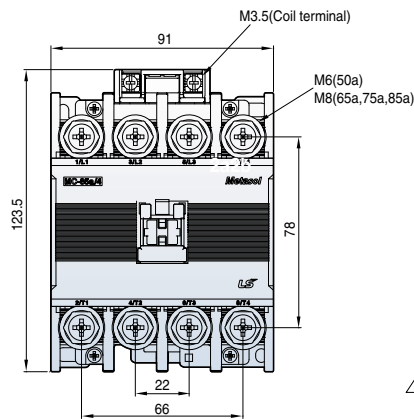

1.2kg

MC-50a/4~85a/4 DC

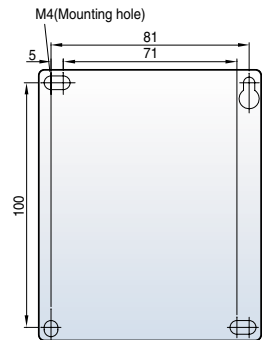
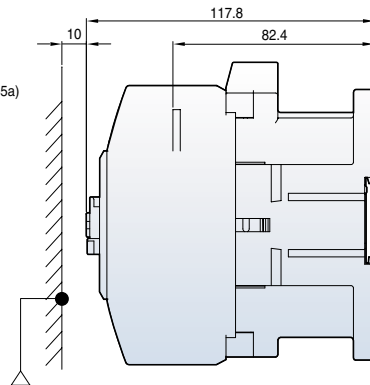
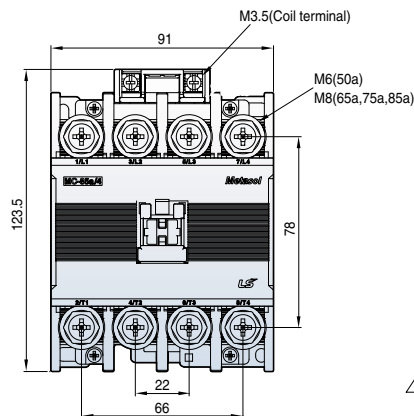

1.29kg

Contactors (MC-100a/4~800a/4)

[mm]

- MC-100a/4
- MC-130a/4
- MC-150a/4
- MC-185a/4
- MC-225a/4

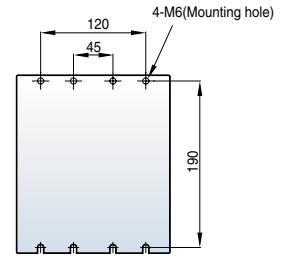
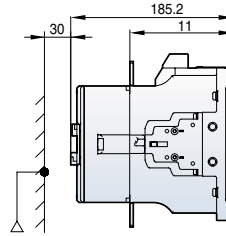
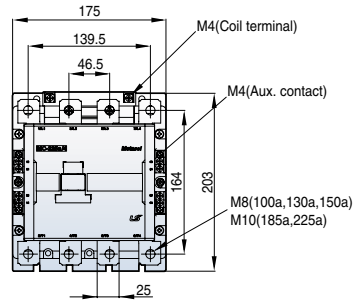

5.6kg

- MC-265a/4
- MC-330a/4
- MC-400a/4

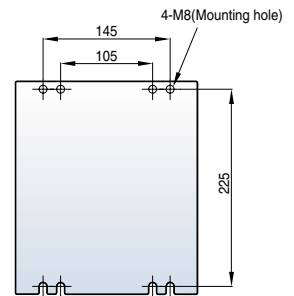
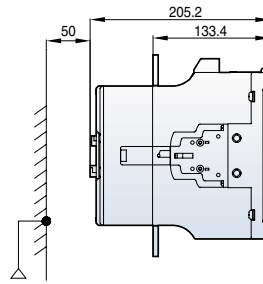
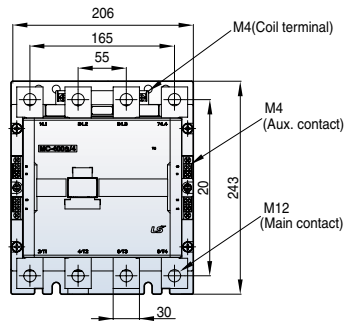

9.9kg

- MC-500a/4
- MC-630a/4
- MC-800a/4

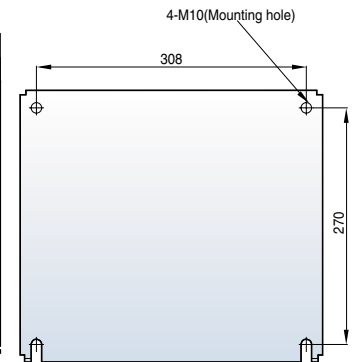
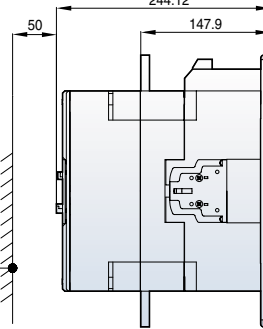
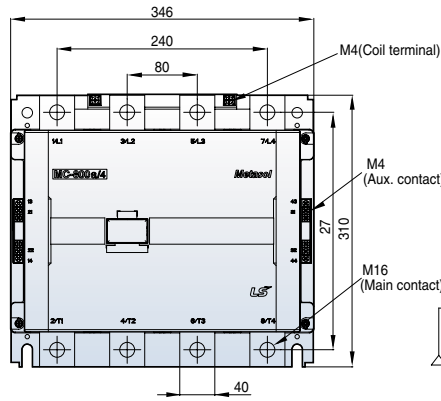

26.3kg

Memo

Memo

Metasol

Leading Innovation, Creating Tomorrow 



Safety Instructions

- For your safety, please read user's manual thoroughly before operating.
- Contact the nearest authorized service facility for examination, repair, or adjustment.
- Please contact a qualified service technician when you need maintenance. Do not disassemble or repair by yourself!
- Any maintenance and inspection shall be performed by the personnel having expertise concerned.

LS Industrial Systems Co., Ltd.

© 2008.10 LS Industrial Systems Co.,Ltd. All rights reserved.

www.lsis.biz

■ HEAD OFFICE

LS Tower 1026-6, Hogue-dong, Dongan-gu,
Anyang-si, Gyeonggi-do 431-848, Korea
Tel. (82-2)2034-4887, 4873, 4918, 4148
Fax. (82-2)2034-4648

■ CHEONG-JU PLANT

Cheong-Ju Plant #1, Song Jung Dong, Hung Duk Ku,
Cheong Ju, 361-720, Korea

■ Global Network

- **LS Industrial Systems (Middle East) FZE >> Dubai, U.A.E.**
Address: LOB 19 JAFZA VIEW TOWER Rm 205, Jebel Ali Freezone P.O. Box 114216, Dubai, U.A.E
Tel: 971-4-886 5360 Fax: 971-4-886-5361 e-mail: jungyongl@lsis.biz
- **Dalian LS Industrial Systems Co., Ltd. >> Dalian, China**
Address: No.15, Liaohexi 3-Road, Economic and Technical Development zone, Dalian 116600, China
Tel: 86-411-8273-7777 Fax: 86-411-8730-7560 e-mail: lixk@lsis.com.cn
- **LS Industrial Systems (Wuxi) Co., Ltd. >> Wuxi, China**
Address: 102-A, National High & New Tech Industrial Development Area, Wuxi, Jiangsu, 214028, P.R.China
Tel: 86-510-8534-6666 Fax: 86-510-522-4078 e-mail: xuhg@lsis.com.cn
- **LS-VINA Industrial Systems Co., Ltd. >> Hanoi, Vietnam**
Address: Nguyen Khe - Dong Anh - Ha Noi - Viet Nam
Tel: 84-4-882-0222 Fax: 84-4-882-0220 e-mail: srjo@lsisvina.com
- **LS-VINA Industrial Systems Co., Ltd. >> Hochiminh, Vietnam**
Address: 41 Nguyen Thi Minh Khai Str. Yoco Bldg 4th Floor, Hochiminh City, Vietnam
Tel: 84-8-3822-7941 Fax: 84-8-3822-7942 e-mail: sbpark@lsisvina.com
- **LS Industrial Systems Tokyo Office >> Tokyo, Japan**
Address: 16FL, Higashi-Kan, Akasaka Twin Tower 17-22, 2-chome, Akasaka, Minato-ku Tokyo 107-8470, Japan
Tel: 81-3-3582-9128 Fax: 81-3-3582-2667 e-mail: jschuna@lsis.biz
- **LS Industrial Systems Shanghai Office >> Shanghai, China**
Address: Room E-G, 12th Floor Huamin Empire Plaza, No.726, West Yan'an Road Shanghai 200050, P.R. China
Tel: 86-21-5237-9977 (609) Fax: 89-21-5237-7191 e-mail: jinhk@lsis.com.cn
- **LS Industrial Systems Beijing Office >> Beijing, China**
Address: B-Tower 17FL, Beijing Global Trade Center B/D. No.36, BeiSanHuanDong-Lu, DongCheng-District, Beijing 100013, P.R. China
Tel: 86-10-5825-6025,7 Fax: 86-10-5825-6026 e-mail: cuixiaorong@lsis.com.cn
- **LS Industrial Systems Guangzhou Office >> Guangzhou, China**
Address: Room 1403,14F,New Poly Tower,2 Zhongshan Liu Road,Guangzhou, P.R. China
Tel: 86-20-8326-6764 Fax: 86-20-8326-6287 e-mail: linsz@lsis.biz
- **LS Industrial Systems Chengdu Office >> Chengdu, China**
Address: Room 1701 17Floor, huanminhanjun international Building, No1 Fuxing Road Chengdu, 610041, P.R. China
Tel: 86-28-8670-3101 Fax: 86-28-8670-3203 e-mail: yangcf@lsis.com.cn
- **LS Industrial Systems Qingdao Office >> Qingdao, China**
Address: 7B40,Haixin Guangchang Shenye Building B, No.9, Shandong Road Qingdao 26600, P.R. China
Tel: 86-532-8501-6568 Fax: 86-532-583-3793 e-mail: lirj@lsis.com.cn

Specifications in this catalog are subject to change without notice due to continuous product development and improvement.