Feature:

- Mounts easy on round & square shaft (with option –8).
- External clutch for manual adjustments.
- Maintenance free.
- Position indicator.
- Fail safe by *Enerdrive System*¹ (on model 60S, 65S & 80S).
- Auxiliary switches (on model 20S & 80S).
- Reliable control for air damper applications up to 12.5 ft² [1.2 m²] (seal-less damper blades; air friction-dependent).

BT100S
BT105S
BT120S
BT160S
BT165S
BT180S
BT200S
BT205S
BT220S
BT260S
BT265S
BT280S

Technical Data	BT100S	BT105S	BT120S	BT200S	BT205S	BT220S	BT160S	BT165S	BT180S	BT260S	BT265S	BT280S
Auxiliary switches	No	No	Yes (2)	No	No	Yes (2)	No	No	Yes (2)	No	No	Yes (2)
Feedback	No	Yes	No	No	Yes	No	No	Yes	No	No	Yes	No
Power supply	110 to 130 VAC 50/60Hz			220 to 250 VAC 50/60Hz			110 to 130 VAC 50/60Hz			220 to 250 VAC 50/60Hz		
Fail safe - Enerdrive	No						Yes					
Power consumption	6 VA						20VA Peak, 6VA					
Control signal	3 wire / 2 position, 4 wire / 3 point floating						2 wire / 2 position, 4 wire / 3 point floating					
Ingress protection	IP22 equivalent to Nema type 2, IP54 equivalent to Nema type 3R if water tight inlet bushings (not supplied NEP617) are installed						IP22 equivalent to Nema type 2					
Running time through 90°	90 - 110 sec, (Fail-safe 20-35 sec)											
Torque	50 in.lb. [5.6 Nm] at rated voltage											
Electrical connection	18 AWG [0.8 mm ²] minimum											
Inlet bushing	2 inlet bushing of 13/16 in [20.6 mm]											
Angle of rotation	0 to 90 degrees, mechanically adjustable (factory set with 90° stroke)											
Direction of rotation	Reversible, Clockwise (CW) or Counterclockwise (CCW) (factory set with CW direction)											
Ambient temperature	-22°F to 122°F [-30°C to 50°C]											
Storage temperature	-22°F to 122°F [-30°C to 50°C]											
Relative Humidity	5 to 95 % non condensing.											
Weight	3 lbs. [1.4 kg]											

Warning: Do not press the clutch when actuator is powered

Dimensions

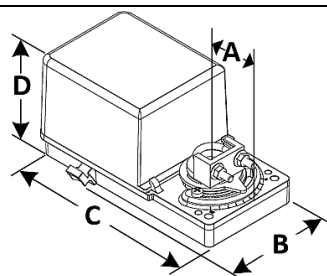

Dimension	Inches	Metric (mm)
A	1.50	38.1
B	3.64	92.5
C	6.60	167.5
D	model 00S, 05S & 20S	3.02 / 76.8
	model 60S, 65S & 80S	3.81 / 96.8

Caution

We strongly recommend that all Neptronic[®] products be wired to a separate transformer and that transformer shall service only Neptronic[®] products. This precaution will prevent interference with, and/or possible damage to incompatible equipment.
 When multiple actuators are wired on a single transformer, polarity must be observed. Long wiring runs create voltage drop which may affect the actuator performance.

¹ Enerdrive System U.S.A. Patent #5,278,454

Mechanical Installation

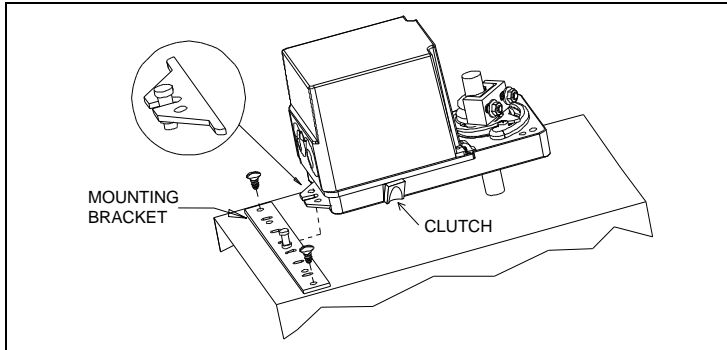

1. Manually close the damper blades and positioned the actuator at 0° or 90°.
2. Slide the actuator onto the shaft.
3. Tighten the nuts on the “U” bolt to the shaft with a 8mm wrench to a torque of 60 in.lb. [6,7 Nm].
4. Slide the mounting bracket under the actuator. Ensure free movement of the slot at the base of the actuator. The bracket pin must be placed in the mid distance of the slot.
5. Fix the bracket to the ductwork with #8 self-tapping screws.

Wiring Diagrams

Caution: Risk of electric shock. Remove power prior to connect.

Models BT100S, 105S, 120S, 200S, 205S & 220S

Models BT160S, 165S, 180S, 260S, 265S & 280S

3 wire / 2 position (ON-OFF)

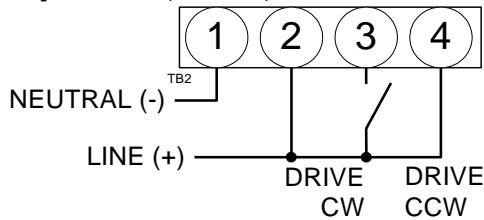

2 wire / 2 position (ON-OFF)

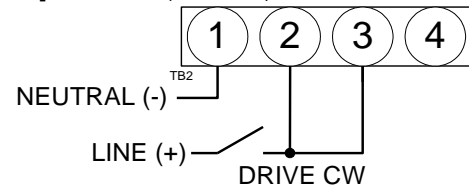

4 wire / 3 point floating

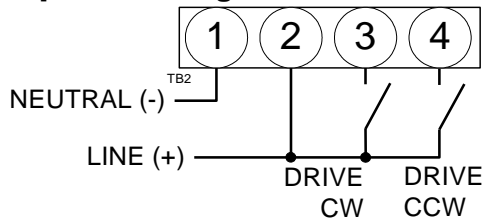

4 wire / 3 point floating

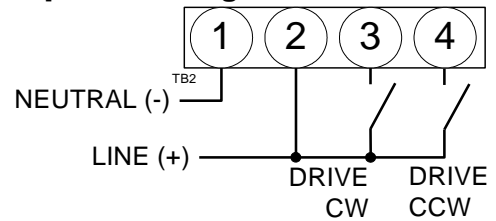

PC Board

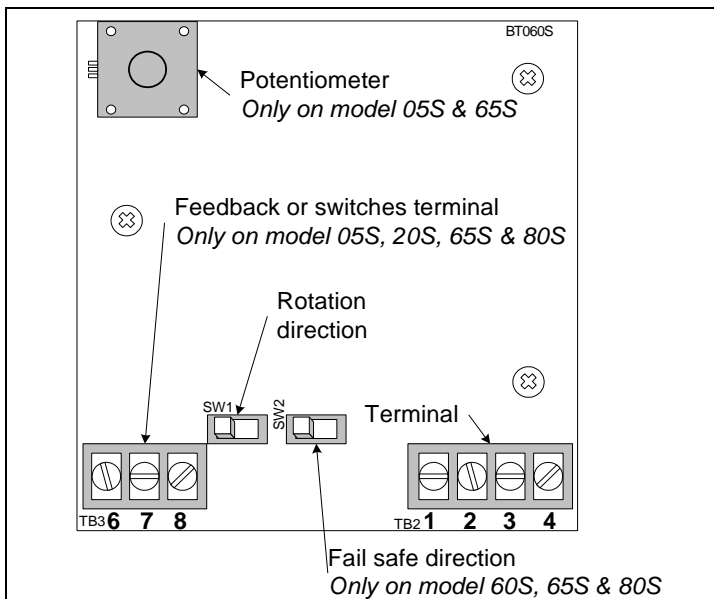

Dip switch settings

Rotation direction (SW1)



Fail safe direction (SW2)



Stroke Adjustment

To adjust the stroke, move the adjustment screws at the desired position.