

Model	Description	Control	Torque	Powe supply
MDB24	Actuator for dampers and shoe valves	On/Off or floating	8 Nm	80...265 Vac/Vdc
MDB44				24 Vac
MDB54		Proportional 2-10 Vdc		
MDB24M	Actuator for dampers and shoe valves with auxiliary microswitches	On/Off or floating		80...265 Vac/Vdc
MDB44M				24 Vac



APPLICATION AND USE

MDB24/44/54 are actuators for dampers and shoe valves for operating air control dampers in ventilation and air-conditioning systems in building services installations for air control dampers up to approx. 2 m².

TECHNICAL CHARACTERISTICS

Control	On/Off + floating (MDB24/44) Proportional (MDB54)
Power supply	
MDB24	80...265 Vac/Vdc (50–60 Hz)
MDB44/54	24 Vac/Vdc ±20%, 50–60 Hz
Consumption	
MDB24	1.5 W / 2.5 VA
MDB44	2.0 W / 3.0 VA
MDB54	2.5 W / 4.5 VA
Connection cable	900 mm / 0.75 mm ²
Rotation angle	Changeable from outside
Torque	8 Nm with nominal voltage
Running time	60...120 s @ 90°
Aux. microswitch	n° 1, changeable from outside
Power supply	
aux. microswitches	250Vac / 5 A (res) 2.5A (ind)
Protection degree	IP54 (downwards cable)
Room temperature	-20T 50°C
Maintenance	free
Weight	about 0.5 Kg

MDB54 only

Control signal Y	2..10 Vdc
	4...20 mA @ 500 Ohm
Feedback signal U	2..10 Vdc

Directive compliance:
EMC 89/336
LVD safety (MDB24) EN 60335-1.

ACCESSORIES

AM 72 Linkage with M3-M4 valves

WIRING DIAGRAMS

MDB24/44

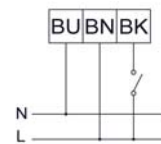

On/Off

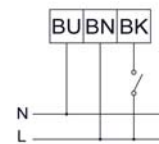

Floating

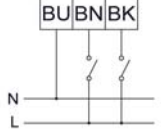

MDB24M/44M

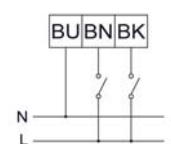

Aux. microswitch

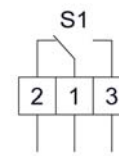

MDB54

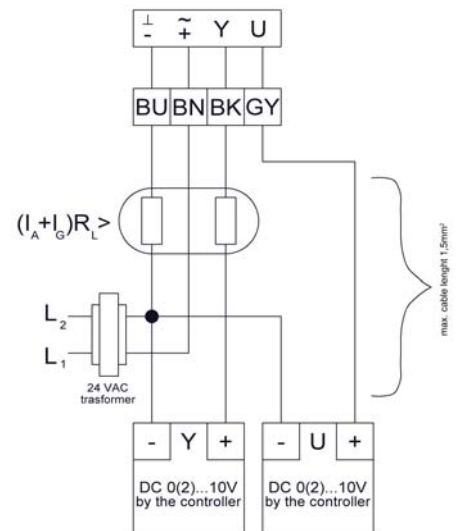

Legend

Code	Colour	Num.
BU	Blue	cabl 1
BN	Brown	cabl 2
BK	Black	cabl 3
GY	Grey	cabl 4

OPERATION

Adjustment of the rotation angle (Fig. 1)

Both end stops are adjusted to 0 (0°) and 1 (90°). For smaller rotation angles, loosen the screws at the metal end stop, adjust the end stops as requested, and fasten the screws again.

Damper shaft locking (Fig. 1)

By the locking clamp to the damper shaft:

Ø 8...12 mm

Ø 8...16 mm

Rotation direction setting (Fig.2)

The actuator is adjusted to clockwise direction by the factory to "R". For changing the direction of rotation, turn the adjusting knob to "L".

Aux. microswitch setting (Fig. 2)

The scale at the adjusting knob corresponds to a percentage graduation, related to 0°...90°.

End stop is set to "0": Switch off the motor and choose the requested switching position by turning the knob to the right, i.e. ".2" = 20%.

End stop is set to "1": Switch off the motor and choose the requested switching position by turning the knob to the left, i.e. ".8" = 20%.

MDB54 setting (Fig.3)

Rotation angle

The actuator is adjusted to clockwise direction by the factory to "R". For changing the direction of rotation, turn the adjusting knob to "L".

Control range

The actuator is designed to modulate its 0°...90° position on a 2 ... 10 Vdc control signal. It is possible to modulate the actuator on lower angular stroke by a stroke learning calibration. It is activated by applying a 15 Vdc voltage to Y and powering the actuator. The actuator will start the stroke learning stage and after it is possible to remove 15 Vdc on Y terminal (see figure).

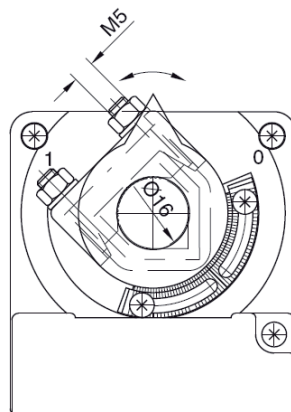

Fig. 1

MDB24-44

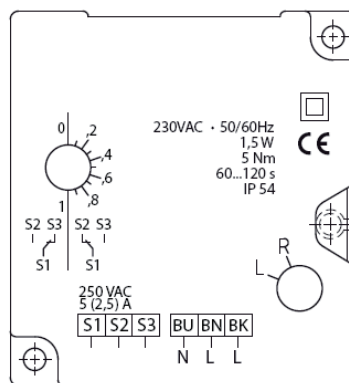

Fig. 2

MDB54

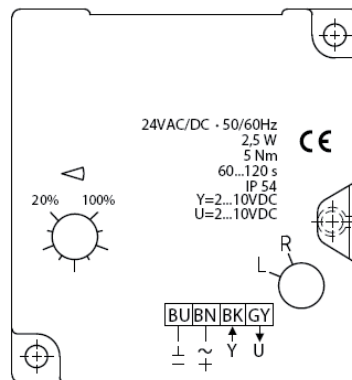
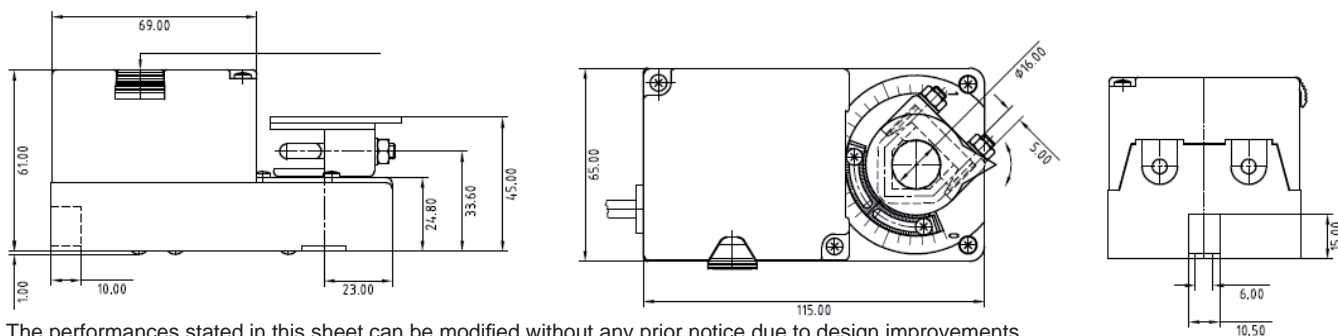

Fig. 3

DIMENSIONS (mm)



The performances stated in this sheet can be modified without any prior notice due to design improvements