

1/8 & 1/16 DIN Controller and Indicator

Product Manual



Manual Part Number: 51-52-25-122

This manual supplements the Concise Product manual supplied with each instrument at the time of shipment. Information in this installation, wiring and operation manual is subject to change without notice.

Copyright © March 2005, Honeywell Inc, all rights reserved. No part of this publication may be reproduced, transmitted, transcribed or stored in a retrieval system, or translated into any language in any form by any means without the written permission of Honeywell Inc.

Copies of this manual are available in electronic format on the Honeywell web site (www.honeywell.com) Printed versions are available from Honeywell or its agents at the price published on the front cover.

Note:

It is strongly recommended that applications incorporate a high or low limit protective device, which will shut down the equipment at a preset process condition in order to prevent possible damage to property or products.



WARNING:

THE INTERNATIONAL HAZARD SYMBOL IS INSCRIBED ADJACENT TO THE REAR CONNECTION TERMINALS. IT IS IMPORTANT TO READ THIS MANUAL BEFORE INSTALLING OR COMMISSIONING THE UNIT.

Products covered by this manual are suitable for Indoor use, Installation Category II, Pollution category 2 environments.

The products covered by this issue of the manual:

DC1200 & DC1700 Process Controllers
DC120L Limit Controller
DI1700 Indicator

Future editions will include other models as they are released:

Warranty and Returns Statement

These products are sold by Honeywell Inc under the warranties set forth in the following paragraphs. Such warranties are extended only with respect to a purchase of these products, as new merchandise, directly from Honeywell Inc or from a Honeywell distributor, representative or reseller and are extended only to the first buyer thereof who purchases them other than for the purpose of resale.

Warranty

These products are warranted to be free from functional defects in material and workmanship at the time the products leave the factory and to conform at that time to the specifications set forth in the relevant Honeywell instruction manuals sheet or sheets, for such products for a period of 18 months.

THERE ARE NO EXPRESSED OR IMPLIED WARRANTIES, WHICH EXTEND BEYOND THE WARRANTIES HEREIN AND ABOVE SET FORTH. HONEYWELL MAKES NO WARRANTY OF MERCHANTABILITY OR FITNESS FOR A PARTICULAR PURPOSE WITH RESPECT TO THE PRODUCTS.

Limitations

Honeywell shall not be liable for any incidental damages, consequential damages, special damages, or any other damages, costs or expenses excepting only the cost or expense of repair or replacement as described above. Products must be installed and maintained in accordance with these instructions. There is no warranty against damage to the product resulting from corrosion. Users are responsible for the suitability of the products to their application.

For a valid warranty claim, the product must be returned carriage paid to the supplier within the warranty period. The product must be properly packaged to avoid damage from Electrostatic Discharge or other forms of harm during transit.

Contents

Warranty and Returns Statement	iv
Contents	v
How to use this manual.....	1
1 Introduction	2
2 Installation	3
Unpacking	3
Installation	3
Panel Cut-outs.....	4
Panel-Mounting	4
3 Plug-in Options.....	6
Options Modules and Functions	6
Auto Detection of Option Modules.....	6
Preparing to Install or Remove Options Modules	8
Removing/Replacing Option Modules	8
Replacing the Instrument in its Housing	11
4 Wiring Instructions.....	12
Installation Considerations	12
AC Power Wiring - Neutral (for 100 to 240V AC versions)	12
Wire Isolation.....	12
Use of Shielded Cable.....	13
Noise Suppression at Source	13
Sensor Placement (Thermocouple or RTD)	14
Thermocouple Wire Identification Chart	14
Connections and Wiring	15
Power Connections - Mains Powered Instruments	17
Power Connections - 24/48V AC/DC Powered Instruments	17
Universal Input Connections - Thermocouple (T/C).....	18
Universal Input Connections - RTD input.....	18
Universal Input Connections - Linear Volt, mV or mA input	19
Option Slot 1 - Relay Module	20
Option Slot 1 - SSR Driver Module	20
Option Slot 1 - Triac Module	20
Option Slot 1 - Linear Voltage or mADC module.....	21

	Option Slot 2 - Relay Module	22
	Option Slot 2 - SSR Driver Module.....	22
	Option Slot 2 - Triac Module.....	22
	Option Slot 2 - Dual Relay Module	23
	Option Slot 2 - Linear Voltage or mADC module.....	23
	Option Slot 3 - Relay Module	24
	Option Slot 3 - SSR Driver Module.....	24
	Option Slot 3 - Linear Voltage or mADC module.....	24
	Option Slot 3 - Dual Relay Module	25
	Option Slot 3 - Transmitter Power Supply Module	25
	Option Slot A Connections - RS485 Serial Communications Module.....	26
	Option Slot A Connections - Digital Input Module	26
	Option Slot A Connections – Basic RSP	26
	Option Slot B Connections – Digital Input 2	27
	Option Slot B Connections – 1/8 DIN Full RSP	27
5	Powering Up.....	28
	Powering Up Procedure.....	28
	Overview Of Front Panel	28
	Displays	29
	LED Functions	29
	Keypad	29
6	Messages and Error Indications	30
7	Instrument Operation Modes.....	31
	Select Mode.....	31
	Entry into the Select Mode	31
	Navigating in Select Mode	31
	Unlock Codes	32
	Automatic Tune Mode	32
	Navigating in Automatic Tune Mode	32
	Product Information Mode	33
	Navigating in the Product Information Mode	33
	Lock Code View.....	35
	Entry and Navigating in Lock Code View Mode	35
8	DC1200 & DC1700 Controllers – Model Group.....	36

DC1200 & DC1700 Controllers - Configuration Mode	36
Entry into the Configuration Mode.....	36
Scrolling through Parameters and Values.....	36
Changing Parameter Values	37
DC1200 & DC1700 Controllers – Setup Mode	43
Entry into the Setup Mode	43
Scrolling through Parameters & Values	43
Changing Parameter Values	43
DC1200 & DC1700 Controllers - Operator Mode	47
DC1200 & DC1700 Controllers – Extended Operator Mode.....	47
Navigating in Operator Mode	47
Adjusting the Local Setpoint(s).....	49
Adjusting the Setpoint Ramp Rate	49
Manual Control Mode	49
Selecting/deselecting Manual Control Mode.....	49
DC1200 & DC1700 Controllers – Serial Communications Parameters	50
Bit Parameters	50
Word Parameters.....	50
9 DC120L Limit Controller	55
DC120L Limit Controller - Configuration Mode.....	55
Entry into the Configuration Mode.....	55
Scrolling through Parameters and Values.....	55
Changing Parameter Values	56
DC120L Limit Controller – Setup Mode.....	61
Entry into the Setup Mode	61
Scrolling through Parameters & Values	61
Changing Parameter Values	61
DC120L Limit Controller - Operator Mode.....	63
Navigating in Operator Mode	63
Limit Setpoint Adjustment.....	63
Exceed Condition	64
Limit Output Function	64
Limit Annunciator Outputs	64
Resetting Limit Outputs & Annunciators	64

	Using The Reset Key To Reset Limit Outputs & Annunciators	64
	Resetting Limit Hold and Exceed Time.....	64
	To reset the stored Limit Hold and Exceed Time values	64
	DC120L Limit Controller – Serial Communications Parameters	65
	Bit Parameters	65
	Word Parameters	65
10	DI1700 Indicator	69
	DI1700 Indicator - Configuration Mode.....	69
	Entry into the Configuration Mode.....	69
	Scrolling through Parameters and Values.....	70
	Changing Parameter Values	70
	DI1700 Indicator - Setup Mode.....	77
	Entry into the Setup Mode.....	77
	Scrolling through Parameters and Values.....	77
	Changing Parameter Values	77
	DI1700 Indicator - Operator Mode	81
	Entry into Operator Mode.....	81
	Scrolling through Parameters and Values.....	81
	Changing Parameter Values	81
	DI17100 Indicator Units Display	83
	Alarm Indications	83
	*Resetting Latched Alarm Outputs	83
	Resetting Alarm 1 Active Time, Minimum PV or Maximum PV.....	83
	Multi-Point Scaling.....	84
	Tare Feature.....	84
	DI1700 Indicator – Serial Communications Parameters.....	85
	Bit Parameters	85
	Word Parameters	86
11	Manual Tuning of Controllers.....	89
	Controllers Fitted With Primary Output Only.....	89
	Controllers Fitted With Primary and Secondary Outputs	90
	Manual Fine Tuning.....	90
12	Modbus Serial Communications	92
	Physical Layer	92

Link Layer.....	93
Device Addressing	94
Supported Modbus Functions.....	94
Function Descriptions.....	94
Read Coil/Input Status (Function 01 / 02)	95
Read Holding/Input Registers (Function 03 / 04)	95
Force Single Coil (Function 05).....	96
Pre-Set Single Register (Function 06)	96
Loopback Diagnostic Test (Function 08).....	96
Pre-Set Multiple Registers (Function 10 Hex).....	97
Exception Responses	97
13 ASCII Communications.....	98
Physical Layer	98
Device Addressing	98
Session Layer.....	98
Type 1 Message	99
Type 2 Message	100
Type 3 Message	100
Type 4 Message	101
Error Response	101
14 Calibration Mode	102
Equipment Required For Checking or Calibrating the Universal Input	102
Calibration Check	102
Recalibration Procedure	103
15 Appendix 1 – Glossary.....	104
Active Setpoint Type: <i>Controller Definition</i>	104
Actual Setpoint Type: <i>Controller Definition</i>	104
Alarm Hysteresis Type: <i>General Parameter</i>	105
Alarm Operation Type: <i>General Definition</i>	106
Alarm Inhibit Type: <i>General Parameter</i>	107
Annunciator Type: <i>Limit Controller Definition</i>	107
Automatic Reset (Integral) Type: <i>Controller Tuning Parameter</i>	107
Auto Pre-Tune Type: <i>Controller Tuning Parameter</i>	107
Band Alarm 1 Value Type: <i>General Parameter</i>	107

Band Alarm 2 Value	Type: <i>General Parameter</i>	107
Bias (Manual Reset)	Type: <i>Controller Tuning Parameter</i>	108
Bumpless Transfer	Type: <i>Controller Definition</i>	108
Cascade Control	Type: <i>Controller Definition</i>	108
Communications Write Enable	Type: <i>General Definition</i>	109
Controller	Type: <i>Controller Definition</i>	109
CPU	Type: <i>General Definition</i>	109
Current Proportioning Control	Type: <i>Controller Definition</i>	109
Cycle Time	Type: <i>Controller Definition</i>	109
Deadband	Type: <i>Controller Parameter</i>	109
Derivative	Type: <i>Controller Parameter</i>	109
Deviation Alarm 1 Value	Type: <i>General Parameter</i>	109
Deviation Alarm 2 Value	Type: <i>General Parameter</i>	110
Differential (On-Off Hysteresis)	Type: <i>Controller Parameter</i>	110
Direct/Reverse Operation of Control Outputs	Type: <i>Controller Definition</i>	110
Display Strategy	Type: <i>General Parameter</i>	110
Elapsed Time	Type: <i>Indicator Definition</i>	110
Exceed Condition	Type: <i>Limit Controller Definition</i>	110
Exceed Time	Type: <i>Limit Controller Definition</i>	111
Indicator	Type: <i>Indicator Definition</i>	111
Input Filter Time Constant	Type: <i>General Parameter</i>	111
Input Range	Type: <i>General Definition</i>	111
Input Span	Type: <i>General Definition</i>	111
Integral	Type: <i>Controller Tuning Parameter</i>	111
Latching Relay	Type: <i>General Definition</i>	111
LED	Type: <i>General Definition</i>	111
Limit Controller	Type: <i>Limit Controller Definition</i>	112
Limit Hysteresis	Type: <i>Limit Controller Definition</i>	112
Limit Setpoint	Type: <i>Limit Controller Definition</i>	112
Lock Codes	Type: <i>General Parameter</i>	112
Logical Combination of Alarms	Type: <i>General Definition</i>	113
Loop Alarm Enable	Type: <i>Controller Parameter</i>	113
Loop Alarm Time	Type: <i>Controller Parameter</i>	114
mADC	Type: <i>General Definition</i>	114

Manual Mode Enable	Type: <i>Controller Parameter</i>	114
Master & Slave	Type: <i>Controller Definition</i>	114
Multi-Point Scaling Enable	Type: <i>Indicator Parameter</i>	114
Multi-Point Scaling Set Up	Type: <i>Indicator Parameter</i>	115
Offset	Type: <i>Controller Parameter</i>	115
On-Off Control	Type: <i>Controller Definition</i>	115
On-Off Differential (Hysteresis)	Type: <i>Controller Parameter</i>	115
Overlap/Deadband	Type: <i>Controller Parameter</i>	116
PID	Type: <i>Controller Definition</i>	117
PLC	Type: <i>General Definition</i>	117
Pre-Tune	Type: <i>Controller Definition</i>	117
Primary Output Power Limit	Type: <i>Controller Parameter</i>	118
Primary Proportional Band	Type: <i>Controller Tuning Parameter</i>	118
Process High Alarm 1 Value	Type: <i>General Parameter</i>	118
Process High Alarm 2 Value	Type: <i>General Parameter</i>	119
Process Low Alarm 1 Value	Type: <i>General Parameter</i>	119
Process Low Alarm 2 Value	Type: <i>General Parameter</i>	119
Process Variable (PV)	Type: <i>General Definition</i>	119
Process Variable Offset	Type: <i>General Parameter</i>	119
Rate (Derivative)	Type: <i>Controller Tuning Parameter</i>	119
Remote Setpoint (RSP)	Type: <i>Controller Definition</i>	120
Remote Setpoint Input Range	Type: <i>Controller Parameter</i>	120
Remote Setpoint Lower Limit	Type: <i>Controller Parameter</i>	120
Remote Setpoint Upper Limit	Type: <i>Controller Parameter</i>	120
Remote Setpoint Offset	Type: <i>Controller Parameter</i>	120
Retransmit Output	Type: <i>General Definition</i>	120
Retransmit Output 1 Scale Maximum	Type: <i>General Parameter</i>	121
Retransmit Output 1 Scale Minimum	Type: <i>General Parameter</i>	121
Retransmit Output 2 Scale Maximum	Type: <i>General Parameter</i>	121
Retransmit Output 2 Scale Minimum	Type: <i>General Parameter</i>	121
Retransmit Output 3 Scale Maximum	Type: <i>General Parameter</i>	121
Retransmit Output 3 Scale Minimum	Type: <i>General Parameter</i>	122
Reset	Type: <i>Controller Tuning Parameter</i>	122
Scale Range Upper Limit	Type: <i>General Parameter</i>	122

Scale Range Lower Limit	Type: <i>General Parameter</i>	122
Secondary Proportional Band	Type: <i>Controller Tuning Parameter</i>	122
Self-Tune	Type: <i>Controller Tuning Definition</i>	123
Serial Communications Option	Type: <i>General Definition</i>	123
Setpoint	Type: <i>Controller Definition</i>	123
Setpoint Upper Limit	Type: <i>Controller Parameter</i>	124
Setpoint Lower Limit	Type: <i>Controller Parameter</i>	124
Setpoint Ramping Enable	Type: <i>Controller Parameter</i>	124
Setpoint Ramp Rate	Type: <i>Controller Parameter</i>	124
Setpoint Select	Type: <i>Controller Parameter</i>	125
Setpoint Select Enable	Type: <i>Controller Parameter</i>	125
Solid State Relay (SSR)	Type: <i>General Definition</i>	125
Tare	Type: <i>Indicator Parameter</i>	125
Time Proportioning Control	Type: <i>Controller Definition</i>	126
Tuning	Type: <i>Controller Definition</i>	126
Triac	Type: <i>General Definition</i>	126
16 Appendix 2 - Specification		127
Universal Input.....		127
General Input Specifications		127
Thermocouple		127
Thermocouple Ranges Available		127
Thermocouple Performance.....		128
Resistance Temperature Detector (RTD).....		128
RTD Ranges Available.....		128
RTD Performance		129
DC Linear		129
DC Linear Ranges Available		129
DC Linear Performance		129
Remote Setpoint Input.....		130
Digital Inputs.....		130
Output Specifications.....		131
Output Module Types.....		131
Specifications of Output Types.....		131
Control Specifications		132

Process Alarms	133
Digital Communications.....	133
Reference Conditions	133
Operating Conditions.....	133
Standards	134
Physical Specifications	134
17 Appendix 3 - Product Coding	135

List of Figures

Page Number:

Figure 1.	Main dimensions	3
Figure 2.	Panel cut-out sizes.....	4
Figure 3.	Panel-Mounting the instrument	4
Figure 4.	Typical rear view (uncased) & main board positions	6
Figure 5.	Location of Option Modules - 1/16 DIN Instruments.....	8
Figure 6.	Location of Option Modules - 1/8 DIN Instruments.....	9
Figure 7.	Option Module Connectors - 1/16 DIN Instruments.....	9
Figure 8.	Option Module Connectors - 1/8 DIN Instruments.....	10
Figure 9.	Transient suppression with inductive coils	13
Figure 10.	Contact noise suppression.....	13
Figure 11.	Rear terminals (1/16-DIN Instruments)	15
Figure 12.	Rear terminals (1/8-DIN Instruments).....	16
Figure 13.	Mains Power Connections.....	17
Figure 14.	24/48V AC/DC Power Connections.....	17
Figure 15.	Thermocouple Input Connections	18
Figure 16.	RTD Input Connections.....	18
Figure 17.	DC Volt, mV & mA Input Connections.....	19
Figure 18.	Option Slot 1 – Relay Module.....	20
Figure 19.	Option Slot 1 - SSR Driver Module.....	20
Figure 20.	Option Slot 1 - Triac Module.....	20
Figure 21.	Option Slot 1 - Linear Voltage & mADC Module.....	21
Figure 22.	Option Slot 2 - Relay Module	22
Figure 23.	Option Slot 2 - SSR Driver Module.....	22
Figure 24.	Option Slot 2 - Triac Module.....	22
Figure 25.	Option Slot 2 - Dual Relay Module	23
Figure 26.	Option Slot 2 - Linear Voltage & mADC module.....	23
Figure 27.	Option Slot 3 - Relay Module	24
Figure 28.	Option Slot 3 - SSR Driver Module.....	24
Figure 29.	Option Slot 3 - Linear Voltage & mADC module.....	24
Figure 30.	Option Slot 3 - Dual Relay Module	25
Figure 31.	Option Slot 3 - Transmitter Power Supply Module	25
Figure 32.	Option Slot A – RS485 Serial Communications Module.....	26
Figure 33.	Option Slot A – Digital Input Module	26

Figure 34.	Option Slot A – Basic RSP Input Module	26
Figure 35.	26	
Figure 36.	Option Slot B – Digital Input 2 Connections	27
Figure 37.	Option Slot B – Full Remote Setpoint Input Connections.....	27
Figure 38.	Typical front panel and keys	28
Figure 39.	Manual Tuning	89
Figure 40.	Modbus Link Layer.....	93
Figure 41.	Alarm Hysteresis Operation	105
Figure 42.	Alarm Operation.....	106
Figure 43.	Overlap and Deadband.....	116
Figure 44.	Pre-Tune Operation	118
Figure 45.	Self-Tune Operation.....	123

List of Tables

Page Number:

Table 1.	Option Module vs. Model Matrix.....	7
Table 2.	Thermocouple Extension Wire Colours.....	14
Table 3.	Typical LED functions	29
Table 4.	Error/Faults conditions	30
Table 5.	Model Groups.....	31
Table 6.	Select Mode Menus	31
Table 7.	Lock Code – Entry and Default Values	32
Table 8.	Automatic Tune Mode Parameters.....	33
Table 9.	Product Information Mode Parameters	33
Table 10.	Lock Code View Menu	35
Table 11.	DC1200 & DC1700 Configuration Mode Parameters.....	37
Table 12.	DC1200 & DC1700 Set Up Mode Parameters	44
Table 13.	DC1200 & DC1700 Operator Mode Displays	47
Table 14.	DC1200 & DC1700 Communications - Bit Parameters	50
Table 15.	DC1200 & DC1700 Communications - Word Parameters.....	50
Table 16.	DC120L Configuration Mode Parameters	56
Table 17.	DC120L Set Up Mode Parameters.....	62
Table 18.	DC120L Operator Mode Displays	63
Table 19.	DC120L Communications - Bit Parameters.....	65
Table 20.	DC120L Communications - Word Parameters	65
Table 21.	DI1700 Configuration Mode Parameters	70
Table 22.	DI1700 Set Up Mode Parameters	78
Table 23.	DI1700 Operator Mode Displays	82
Table 24.	DI1700 Communications - Bit Parameters	85
Table 25.	DI1700 Communications - Word Parameters.....	86
Table 26.	Supported Modbus Functions	94
Table 27.	Read Coil/Input Status (Modbus Function 01/02).....	95
Table 28.	Read Holding/Input Registers (Modbus Function 03/04).....	95
Table 29.	Force Single Coil (Modbus Function 05)	96
Table 30.	Pre-Set Single Register (Modbus Function 06)	96
Table 31.	Loopback Diagnostic Test (Modbus Function 08)	96
Table 32.	Pre-Set Multiple Registers (Modbus Function 10 Hex)	97
Table 33.	Modbus Exception Responses.....	97

Table 34.	ASCII Parameter Key.....	99
Table 35.	ASCII Data Element – Sign/Decimal Point Position.....	99
Table 36.	Input Calibration phases	103
Table 37.	Logical Alarm Outputs.....	113

How to use this manual

This manual is structured to give easy access to the information required for all aspects of the installation and use and of the products:

- Section 1: **Introduction** - A brief description of the product range.
- Section 2: **Installation** - Unpacking, installing and panel mounting instructions.
- Section 3: **Plug-in Options** - Installation of the plug-in option modules.
- Section 4: **Wiring Guidelines** - Guidance on good wiring practice, noise avoidance, wiring diagrams and input/output connections.
- Section 5: **Powering Up** - Powering up procedure and brief description of the displays and switches.
- Section 6: **Messages & Error Indications** - Display Messages and fault indications.
- Section 7: **Operation Modes** - Descriptions of the operation modes common across the range. These include Select Mode for gaining access to the Setup and Configuration menus, Automatic tuning on controllers and the Product information menu.
- Section 8: **DC1200 & DC1700 Model Group** - Describes the menus and features unique to the process controllers in this model group. These include Configuration Mode, Setup Mode & Operator Mode menus, and the serial communications parameters. Also detailed is Setpoint adjustment, use of Manual Control Mode and automatic PID tuning.
- Section 9: **Model DC120L** - Describes the menus and features unique to the limit controllers in this model group. These include Configuration Mode, Setup Mode & Operator Mode menus, and the serial communications parameters. Also detailed is adjustment of the Limit Setpoint and resetting the Limit Output.
- Section 10: **Model DI1700** - Describes the menus and features unique to the indicators in this model group. These include Configuration Mode, Setup Mode & Operator Mode menus, and the serial communications parameters. Also detailed the Tare and Multi-Point Scaling Functions.
- Section 11: **Manually Tuning Controllers** - Advice on manually adjusting the PID controller tuning parameters.
- Section 12: **Modbus Serial Communications** - Details the physical layer and message formats used for the Modbus communications protocol common to all products in the range.
- Section 13: **ASCII Serial Communications** - Details the physical layer and message formats used for the ASCII serial communications protocol available on some products.
- Section 14: **Calibration Mode** - Step-by-step instructions to calibrate the instrument. This section is intended for use by suitably qualified personnel.
- Appendix 1: **Glossary** - Explanations of the terms used and product features.
- Appendix 2: **Specification** - Technical specifications for all products in the range.
- Appendix 3: **Product Coding** - Product model/ordering codes.

1 Introduction

These instruments are microprocessor based process controllers, indicators, and limit controllers. They can measure, display or control process variables such as temperature, pressure, flow and level from a variety of inputs.

The operating voltage is either 100-240V at 50/60 Hz or 24V-48V AC/DC depending on the model purchased. EEPROM technology protects against data or configuration loss during power outages.

Inputs are user configurable for connection to thermocouple and RTD probes, as well as linear process signal types such as mVDC, VDC or mADC. Output options include relays, SSR drivers, triacs or linear mV/voltage modules. These can be used for process control, alarms, or retransmission of the process variable or setpoint to external devices such as data recorders and PLC's. A Transmitter Power Supply option module can provide an unregulated 24V DC (22mA) auxiliary output voltage for external signal transmitters.

Alarm indication is standard on all instruments; up to five alarms are possible on the indicators. Alarms may be set as process high or low, deviation (active above or below controller setpoint), band (active both above and below setpoint), or control loop types. These alarms can be linked to any suitable output. Alarm status is indicated by LED's or the alarm status screen.

Controllers can be programmed for on-off, time proportioning, or current proportioning control implementations, depending on the output modules fitted, and feature manual or automatic tuning of the PID parameters. A secondary control output is available when additional output modules are fitted. Three Position Step Control (Valve Motor Drive) is also possible on some models. Controllers with analogue Remote Setpoint inputs are also included in the range. Control functions, alarm settings and other parameters are easily adjusted from the front keypad or via PC based configuration software.

Limit Controllers shut down a process in order to prevent possible damage to equipment or products. They have latching relay, which cannot be reset until the process is in a safe condition. Limit controllers work independently of the normal process controller and have approvals for safety critical applications.

Indicator models can display a process value and provide multiple stage alarm outputs. Additional features include Multipoint scaling to compensate for non-linear signals and a Tare function to auto-zero the current reading.

2 Installation

Unpacking

1. Remove the product from its packing. Retain the packing for future use, in case it is necessary to transport the instrument to a different site or to return it to the supplier for repair/testing.
2. The instrument is supplied with a panel gasket and push fit fixing strap. A single sheet concise manual is also supplied in one or more languages. Examine the delivered items for damage or defects. If any are found, contact your supplier immediately.

Installation

CAUTION:

Installation and configuration should be performed only by personnel who are technically competent and authorised to do so. Local regulations regarding electrical installation and safety must be observed.

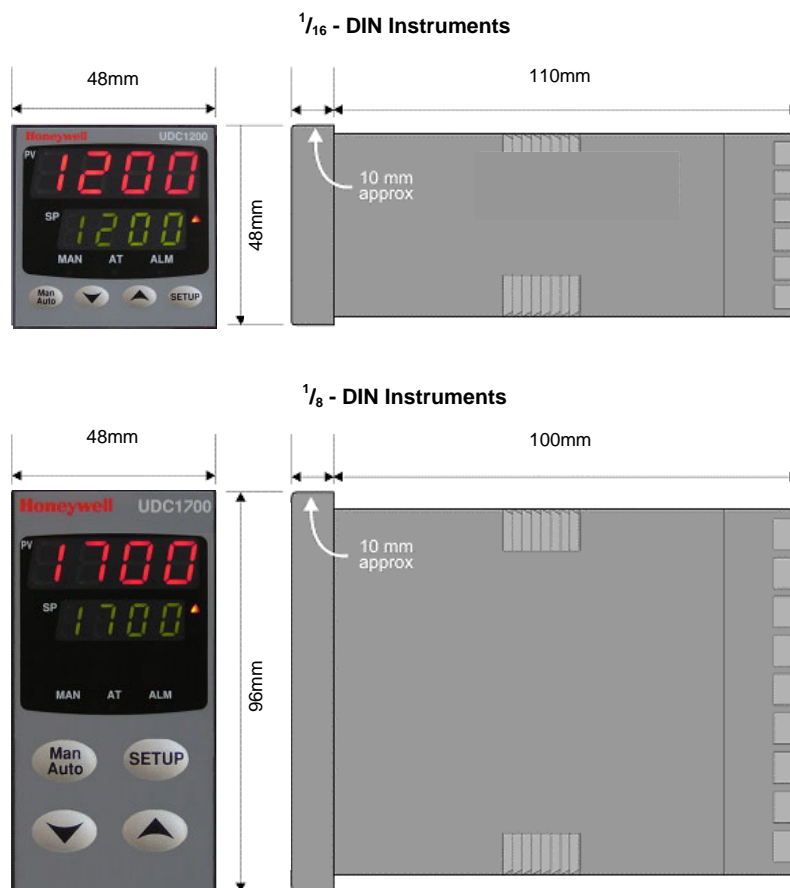

Figure 1. Main dimensions

Panel Cut-outs

The mounting panel must be rigid and may be up to 6.0mm (0.25 inches) thick. The cut-outs required for the instruments are shown below.

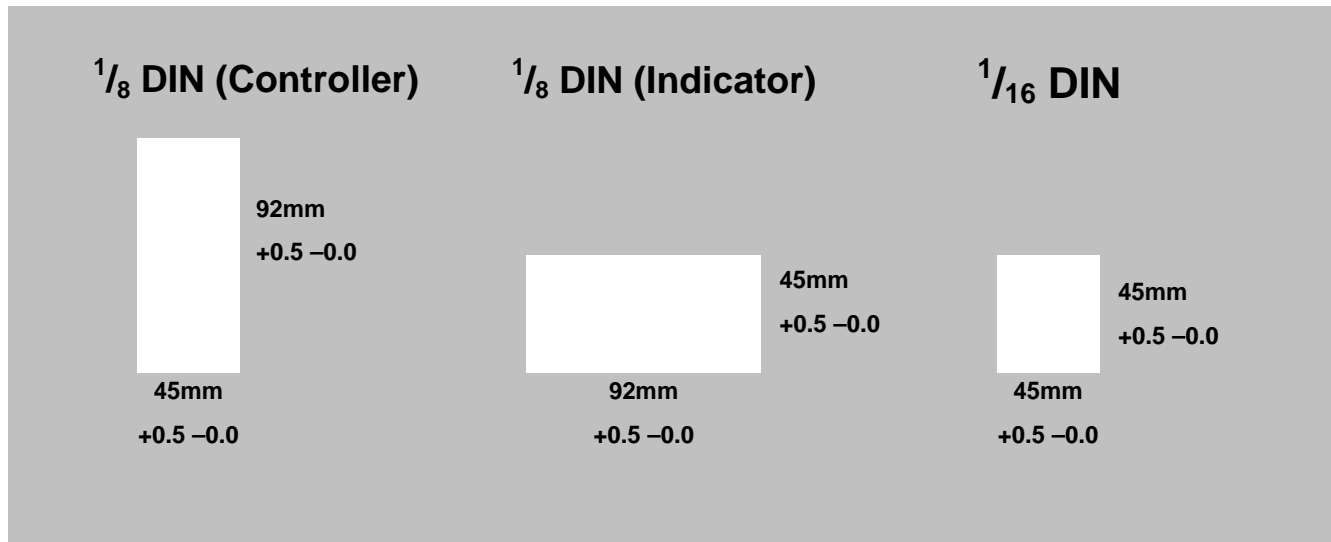

Figure 2. Panel cut-out sizes

Panel-Mounting

CAUTION:

Ensure the inside of the panel is with the instruments operating temperature and that there is adequate air flow to prevent overheating.

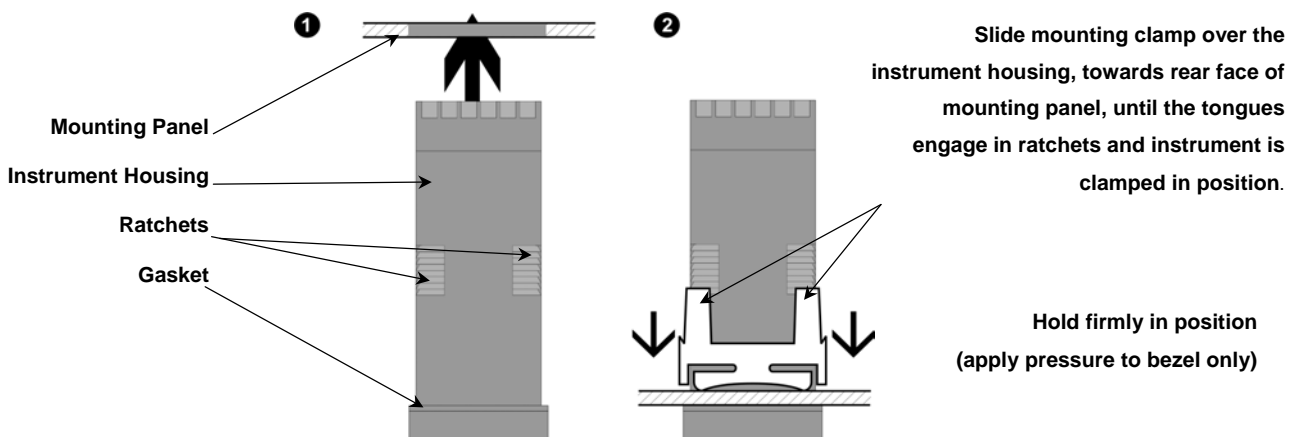

Figure 3. Panel-Mounting the instrument

CAUTION:

Do not remove the panel gasket, as this may result in inadequate clamping and sealing of the instrument to the panel.

Once the instrument is installed in its mounting panel, it may be subsequently removed from its housing, if necessary, as described in the Fitting and Removing Option Modules section.

Instruments may be mounted side-by-side in a multiple installation, but instrument to panel moisture and dust sealing will be compromised. Cut-out width (for n instruments) is:

$\frac{1}{8}$ - & $\frac{1}{16}$ - **DIN Controllers:** (48n - 4) mm or (1.89n - 0.16) inches

$\frac{1}{8}$ - **DIN Indicators:** (96n - 4) mm or (3.78n - 0.16) inches

If panel sealing must be maintained, mount each instrument into an individual cut-out with 6mm or more clearance between the edges of the holes.

Note:

The mounting clamp tongues may engage the ratchets either on the sides or the top/bottom faces of the Instrument housing. When installing several Instruments side-by-side in one cut-out, use the ratchets on the top/bottom faces.

3 Plug-in Options

Options Modules and Functions

A range of plug-in option modules is available to add additional input, output and communication functions to the instruments in the range. These modules can be either pre-installed at the time of manufacture, or retrofitted in the field.

The modules are installed between the instruments main circuit boards into the four option slots. These are designated as Slots 1, 2, 3, A & B. Installation is detailed below.

Note:

Slot 1 modules cannot be fitted into Slot 2 or 3. Slot 2 & 3 modules cannot be fitted into Slot 1. Some Slot 2 & 3 modules should only be fitted into one of the two slots. This is detailed in the - Option Module vs. Model Matrix below.

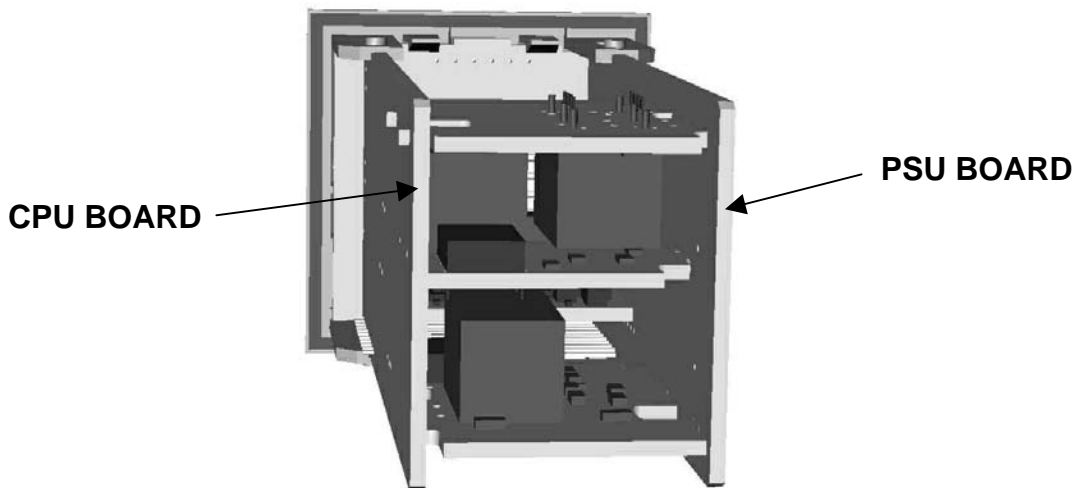

Figure 4. Typical rear view (uncased) & main board positions

Auto Detection of Option Modules

The instrument automatically detects which option modules have been fitted into each slot. In Configuration Mode, the menus will change to reflect the options compatible with the hardware fitted. The modules fitted can be viewed in the Product Information Mode.

Table 1. Option Module vs. Model Matrix

MODULE PART NUMBER & Function	MODEL NUMBER					
	UDC1200	UDC120L	UDC120T	UDC1700	UDC170T	UDI1700
OPTION SLOT 1						
51453391-501 Relay	Green	Green	Green	Green	Green	Green
51453391-502 SSR Driver	Green	Red	Red	Green	Red	Green
51453391-503 Triac	Green	Red	Red	Green	Red	Green
51453391-504 Linear mA/V DC	Green	Red	Red	Green	Red	Green
OPTION SLOT 2						
51453391-506 Relay	Green	Green	Green	Green	Green	Green
51453391-507 SSR Driver	Green	Green	Red	Green	Red	Green
51453391-508 Triac	Green	Green	Red	Green	Red	Green
51453391-509 Linear mA/V DC	Green	Green	Red	Green	Red	Green
51453391-510 Dual Relay	Red	Red	Red	Red	Red	Green
OPTION SLOT 3						
51453391-506 Relay	Green	Green	Green	Green	Green	Green
51453391-507 SSR Driver	Green	Green	Green	Green	Green	Green
51453391-509 Linear mA/V DC	Green	Green	Green	Green	Green	Green
51453391-510 Dual Relay	Red	Red	Red	Red	Red	Green
51453391-111 Transmitter PSU	Green	Green	Green	Green	Green	Green
OPTION SLOT A						
51453391-512 RS485 Comms	Green	Green	Green	Green	Green	Green
51453391-513 Digital Input	Green	Green	Green	Green	Green	Green
51453391-515 Basic RSP Input	Green	Red	Red	Green	Red	Red
OPTION SLOT B						
51453391-516 Full RSP Input	Red	Red	Red	Green	Red	Red
SOFTWARE & ACCESSORIES						
51453391-514 Config Software	Green	Green	Green	Green	Green	Green
KEY	Option Possible	Green	Option Not Possible			Red

Preparing to Install or Remove Options Modules

CAUTION:

Before removing the instrument from it's housing, ensure that all power has been removed from the rear terminals.

1. Remove the instrument from its housing by gripping the side edges of the front panel (there is a finger grip on each edge) and pull the instrument forwards. This will release the instrument from the rear connectors in the housing and will give access to the PCBs.
2. Take note of the orientation of the instrument for subsequent replacement into the housing. The positions of the main and option PCBs in the instrument are shown below.

Removing/Replacing Option Modules

With the instrument removed from its housing:

1. To remove or replace modules into Option Slots 1,A or B, it is necessary to gently separate the CPU and PSU PCBs. This is achieved by detaching the main boards (PSU and CPU) from the front moulding by lifting first the upper and then lower mounting struts as shown. This frees the boards from the front. If only Option slots 2 or 3 are to be changed, this stage is not required as these slots are accessible without separating the main boards from the front.

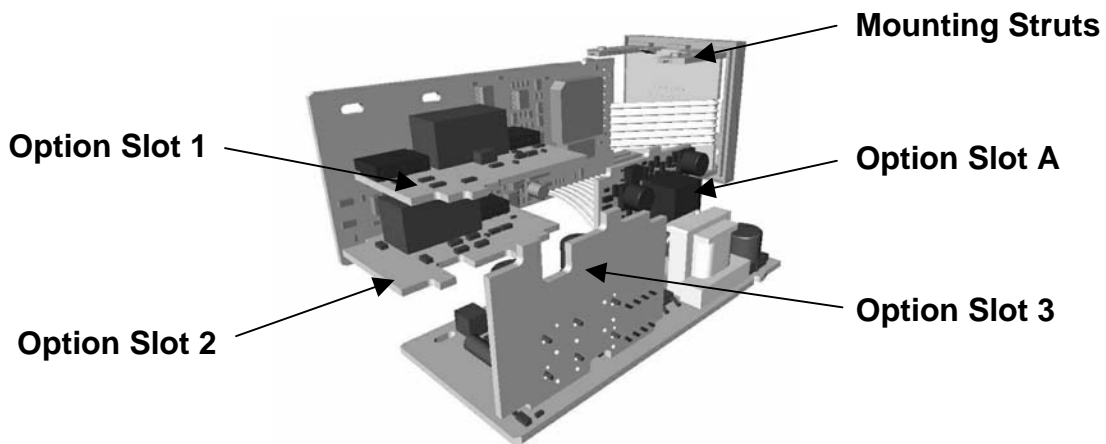

Figure 5. Location of Option Modules - 1/16 DIN Instruments

CAUTION:

Take care not to put undue stress on the ribbon cable attaching the display and CPU boards.

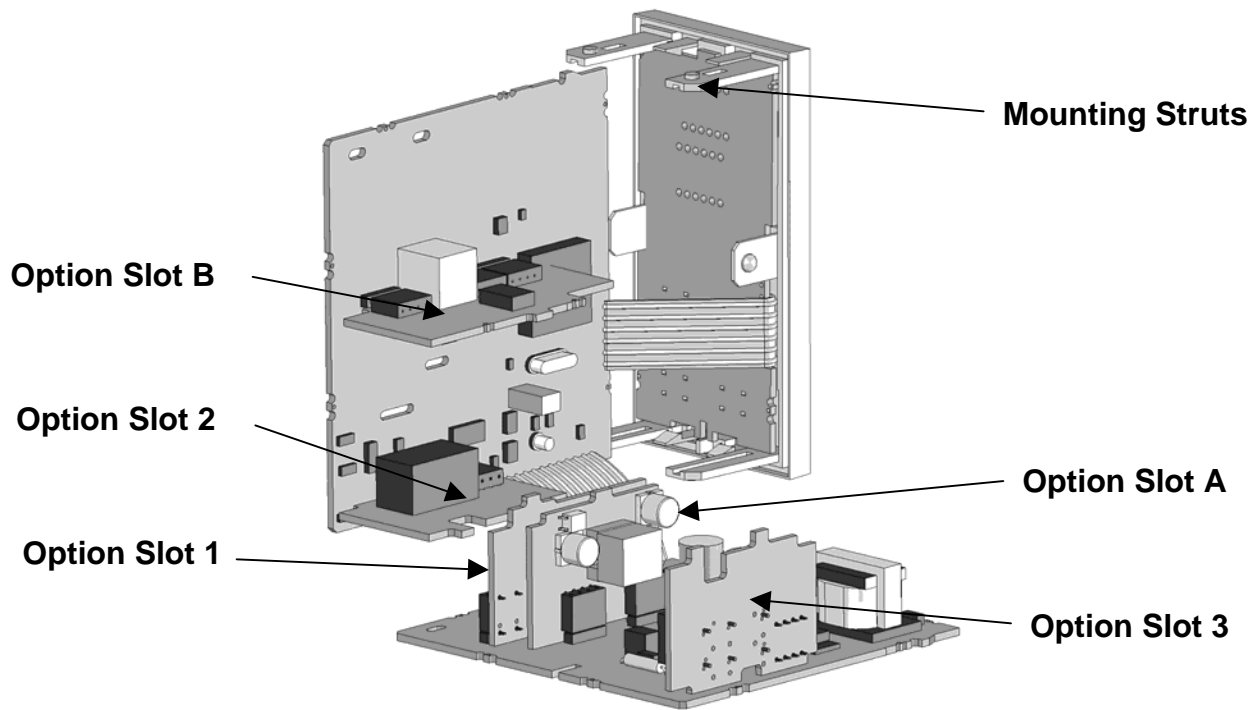

Figure 6. Location of Option Modules - 1/8 DIN Instruments

CAUTION:

Take care not to put undue stress on the ribbon cable attaching the display and CPU boards.

- Remove or fit the modules into the Option slots as required. The location of the connectors is shown below. Tongues on each option module locate into a slots cut into the main boards, opposite each of the connectors.

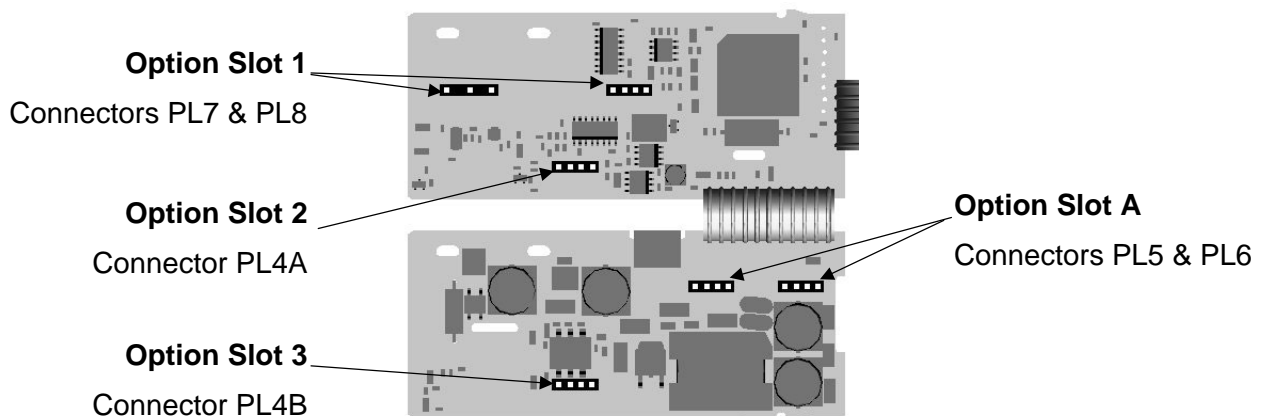

Figure 7. Option Module Connectors - 1/16 DIN Instruments

CAUTION:

Check for correct orientation of the modules and that all pins locate correctly into the socket

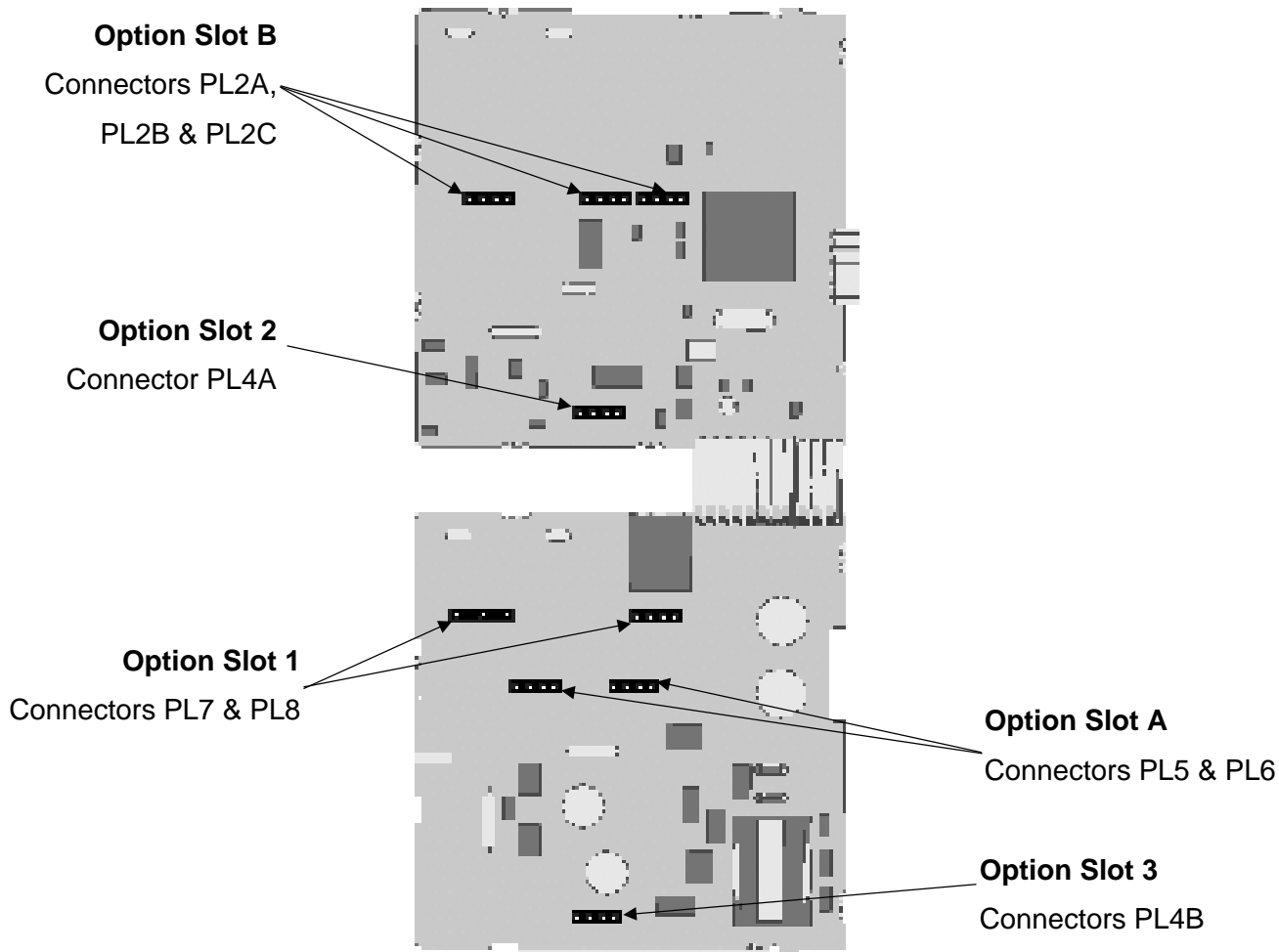

Figure 8. Option Module Connectors - 1/8 DIN Instruments

CAUTION:

Check for correct orientation of the modules and that all pins locate correctly into the socket

Replacing the Instrument in its Housing

With the required option modules correctly located into their respective positions the instrument can be replaced into its housing as follows:

1. If required, move the CPU and PSU boards back together, taking care to locate the option module tongues into the slots in the board opposite. Hold the main boards together whilst relocating them back into the mounting struts on the front panel.
2. Align the CPU and PSU PCBs with their guides and connectors in the housing.
3. Slowly and firmly, push the instrument in position.

CAUTION:

Ensure that the instrument is correctly orientated. A mechanical stop will operate if an attempt is made to insert the instrument in the wrong orientation, this stop MUST NOT be over-ridden.

4 Wiring Instructions

Electrical noise is a phenomenon typical of industrial environments. As with any instrumentation, these guidelines should be followed to minimize the effect of noise.

Installation Considerations

Ignition transformers, arc welders, mechanical contact relays and solenoids are all common sources of electrical noise in an industrial environment and therefore the following guidelines MUST be followed.

1. If the instrument is being installed in existing equipment, the wiring in the area should be checked to ensure that good wiring practices have been followed.
2. Noise-generating devices such as those listed should be mounted in a separate enclosure. If this is not possible, separate them from the instrument, by the largest distance possible.
3. If possible, eliminate mechanical contact relays and replace with solid-state relays. If a mechanical relay being powered by an output of this instrument cannot be replaced, a solid-state relay can be used to isolate the instrument.
4. A separate isolation transformer to feed only the instrumentation should be considered. The transformer can isolate the instrument from noise found on the AC power input.

AC Power Wiring - Neutral (for 100 to 240V AC versions)

It is good practice to ensure that the AC neutral is at or near ground (earth) potential. A proper neutral will help ensure maximum performance from the instrument.

Wire Isolation

Four voltage levels of input and output wiring may be used with the unit:

1. Analogue input or output (for example thermocouple, RTD, VDC, mVDC or mADC)
2. Relays & Triac outputs
3. SSR Driver outputs
4. AC power

CAUTION:

The only wires that should run together are those of the same category.

If any wires need to run parallel with any other lines, maintain a minimum space of 150mm between them.

If wires MUST cross each other, ensure they do so at 90 degrees to minimise interference.

Use of Shielded Cable

All analogue signals must use shielded cable. This will help eliminate electrical noise induction on the wires. Connection lead length must be kept as short as possible keeping the wires protected by the shielding. The shield should be grounded at one end only. The preferred grounding location is at the sensor, transmitter or transducer.

Noise Suppression at Source

Usually when good wiring practices are followed, no further noise protection is necessary. Sometimes in severe electrical environments, the amount of noise is so great that it has to be suppressed at source. Many manufacturers of relays, contactors etc supply 'surge suppressors' which mount on the noise source. For those devices that do not have surge suppressors supplied, Resistance-Capacitance (RC) networks and/or Metal Oxide Varistors (MOV) may be added.

Inductive coils:- MOVs are recommended for transient suppression in inductive coils, connected in parallel and as close as possible to the coil. Additional protection may be provided by adding an RC network across the MOV.

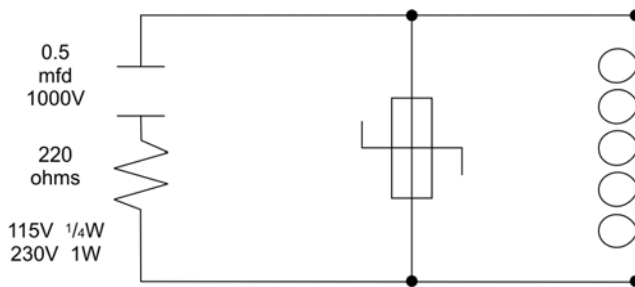

Figure 9. Transient suppression with inductive coils

Contacts:- Arcing may occur across contacts when they open and close. This results in electrical noise as well as damage to the contacts. Connecting a properly sized RC network can eliminate this arc.

For circuits up to 3 amps, a combination of a 47 ohm resistor and 0.1 microfarad capacitor (1000 volts) is recommended. For circuits from 3 to 5 amps, connect two of these in parallel.

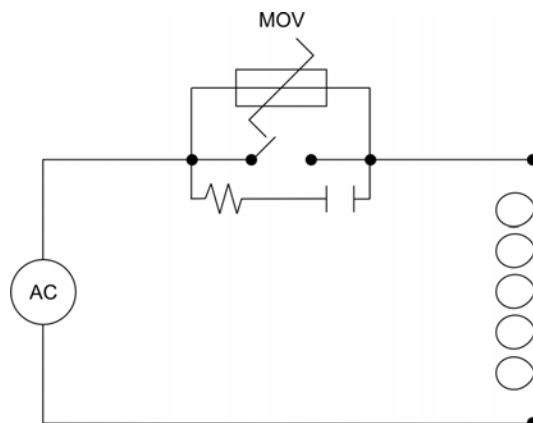

Figure 10. Contact noise suppression

Sensor Placement (Thermocouple or RTD)

If the temperature probe is to be subjected to corrosive or abrasive conditions, it must be protected by an appropriate thermowell. The probe must be positioned to reflect true process temperature:

1. In a liquid media - the most agitated area
2. In air - the best circulated area

CAUTION:

The placement of probes into pipe work some distance from the heating vessel leads to transport delay, which results in poor control.

For a two wire RTD a wire link should be used in place of the third wire. Two wire RTDs must only be used with lead lengths less than 3 metres. Use of three wire RTDs is strongly recommended.

Thermocouple Wire Identification Chart

The different thermocouple types are identified by their wires colour, and where possible, the outer insulation as well. There are several standards in use throughout the world.

The table below shows the wire and sheath colours used for most common thermocouple types. The format used in this table is:

+ Wire	Sheath
- Wire	

Table 2. Thermocouple Extension Wire Colours

Type		International IEC584-3	USA ANSI MC 96.1	British BS1843	French NFC 42-324	German DIN 43710
J	+*	Black Black	White Black	Yellow Black	Yellow Black	Red Blue
	-	White Black	Red Black	Blue Black	Black Black	Blue Blue
T	+	Brown Brown	Blue Blue	White Blue	Yellow Blue	Red Brown
	-	White Brown	Red Blue	Blue Blue	Blue Blue	Brown Brown
K	+	Green Green	Yellow Yellow	Brown Red	Yellow Yellow	Red Green
	-*	White Green	Red Yellow	Blue Red	Purple Yellow	Green Green
N	+	Pink Pink	Orange Orange	Orange Orange		
	-	White Pink	Red Orange	Blue Orange		
B	+	Grey Grey	Grey Grey			Red Grey
	-	White Grey	Red Grey			Grey Grey
R & S	+	Orange Orange	Black Green	White Green	Yellow Green	Red White
	-	White Orange	Red Green	Blue Green	Green Green	White White
C (W5)	+		White White			
	-		Red White			

Note:

* = Wire is magnetic

WARNING:

TO AVOID ELECTRICAL SHOCK, AC POWER WIRING MUST NOT BE CONNECTED TO THE SOURCE DISTRIBUTION PANEL UNTIL ALL WIRING PROCEDURES ARE COMPLETED.

WARNING:

CHECK THE INFORMATION LABEL ON THE CASE TO DETERMINE THE CORRECT VOLTAGE BEFORE CONNECTING TO A LIVE SUPPLY.

Note:

The wiring diagram below shows all possible combinations. The actual connections required depend upon the features available on the model and the modules and options fitted.

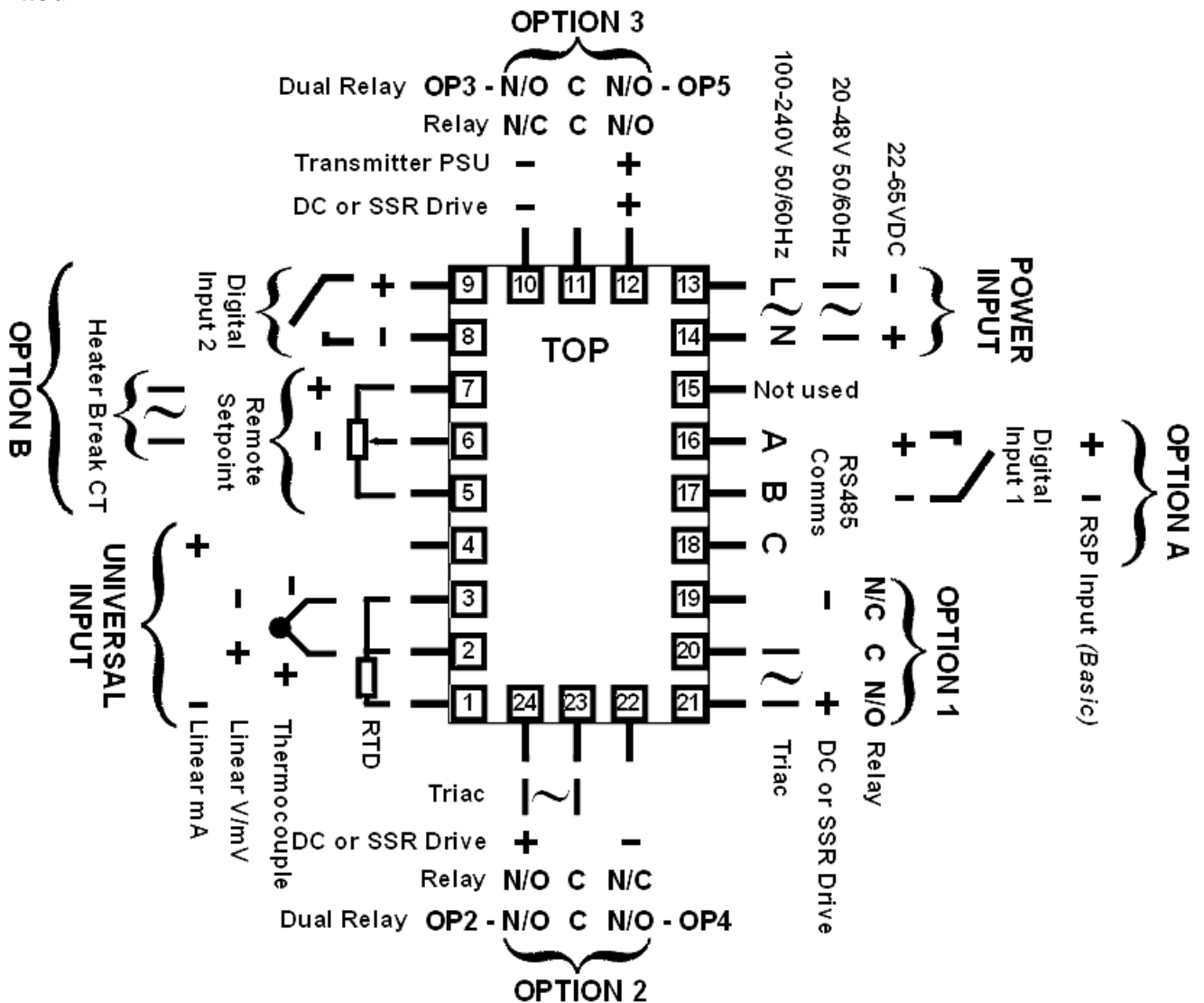

Figure 12. Rear terminals (1/8-DIN Instruments)

Power Connections - Mains Powered Instruments

Mains powered instruments operate from a 100 to 240V (±10%) 50/60Hz supply. Power consumption is 7.5VA. Connect the line voltage (live and neutral) as illustrated via a two-pole isolating switch (preferably located near the equipment) and a 1amp anti-surge fuse. If the instrument has relay outputs with contacts carrying mains voltage, it is recommended that the relay contacts supply should be switched and fused in a similar manner, but should be separate from the instruments mains supply.

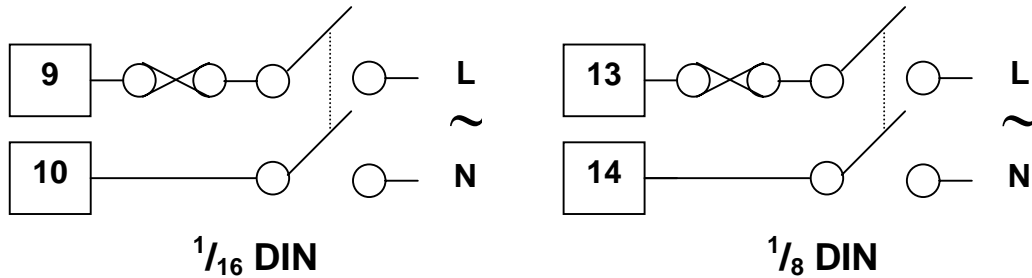

Figure 13. Mains Power Connections

WARNING:

CHECK THE INFORMATION LABEL ON THE CASE TO DETERMINE THE CORRECT VOLTAGE BEFORE CONNECTING TO A LIVE SUPPLY.

CAUTION:

This equipment is designed for installation in an enclosure that provides adequate protection against electric shock

Power Connections - 24/48V AC/DC Powered Instruments

24/48V AD/DC powered instruments will operate from a 20 to 48V AC or 22 to 55V DC supply. AC power consumption is 7.5VA max, DC power consumption is 5 watts max. Connection should be via a two-pole isolating switch (preferably located near the equipment) and a 315mA slow-blow (anti-surge type T) fuse.

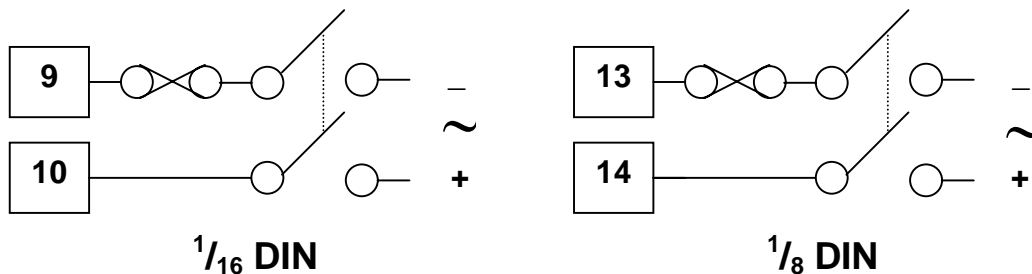

Figure 14. 24/48V AC/DC Power Connections

WARNING:

CHECK THE INFORMATION LABEL ON THE CASE TO DETERMINE THE CORRECT VOLTAGE BEFORE CONNECTING TO A LIVE SUPPLY.

Universal Input Connections - Thermocouple (T/C)

Use only the correct thermocouple wire or compensating cable from the probe to the instrument terminals avoiding joints in the cable if possible. Failure to use the correct wire type will lead to inaccurate readings. Ensure correct polarity of the wires by cross-referencing the colours with a thermocouple reference table.



Figure 15. Thermocouple Input Connections

Universal Input Connections - RTD input

For three wire RTDs, connect the resistive leg and the common legs of the RTD as illustrated. For a two wire RTD a wire link should be used in place of the third wire (shown by dotted line). Two wire RTDs should only be used when the leads are less than 3 metres long. Avoid cable joints.

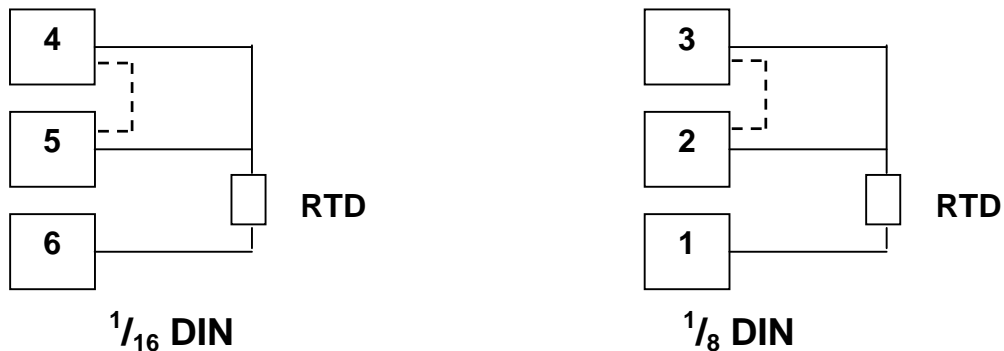

Figure 16. RTD Input Connections

Four wire RTD's can be used, provided that the fourth wire is left unconnected. This wire should be cut short or tied back so that it cannot contact any of the terminals on the rear of the instrument.

Universal Input Connections - Linear Volt, mV or mA input

Linear DC voltage, millivolt or milliamp input connections are made as illustrated. Carefully observe the polarity of the connections.

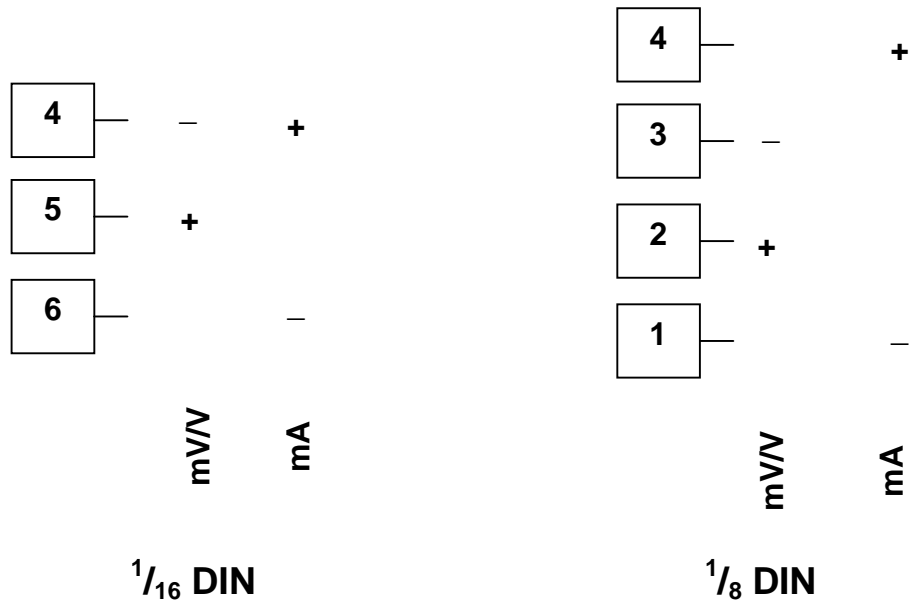

Figure 17. DC Volt, mV & mA Input Connections

Option Slot 1 - Relay Module

If option slot 1 is fitted with a relay output module, make connections as illustrated. The relay contacts are rated at 2 amps resistive, 120/240 VAC.

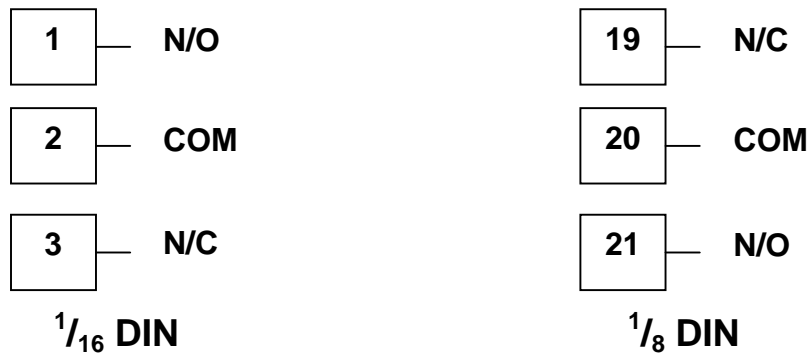

Figure 18. Option Slot 1 – Relay Module

Option Slot 1 - SSR Driver Module

If option slot 1 is fitted with an SSR driver output module, make connections as illustrated. The solid-state relay driver is a 0-10V DC signal, load impedance must be no less than 500 ohms. SSR driver outputs are not isolated from the signal input or other SSR driver outputs.



Figure 19. Option Slot 1 - SSR Driver Module

Option Slot 1 - Triac Module

If option slot 1 is fitted with a Triac output module, make connections as illustrated. The triac output is rated at 0.01 to 1 amp @ 240V AC 50/60Hz.



Figure 20. Option Slot 1 - Triac Module

Option Slot 1 - Linear Voltage or mADC module

If option slot 1 is fitted with a DC linear output module, make connections as illustrated.



Figure 21. Option Slot 1 - Linear Voltage & mADC Module

Option Slot 2 - Relay Module

If option slot 2 is fitted with a relay output module, make connections as illustrated. The contacts are rated at 2 amp resistive 120/240 VAC.



Figure 22. Option Slot 2 - Relay Module

Option Slot 2 - SSR Driver Module

If option slot 2 is fitted with an SSR driver output module, make connections as illustrated. The solid-state relay driver is a 0-10V DC signal, load impedance must be no less than 500 ohms. SSR driver outputs are not isolated from the signal input or other SSR driver outputs.



Figure 23. Option Slot 2 - SSR Driver Module

Option Slot 2 - Triac Module

If option slot 2 is fitted with a triac output module, make connections as illustrated. The triac is rated at 0.01 to 1 amp @ 240V AC 50/60Hz



Figure 24. Option Slot 2 - Triac Module

WARNING:

THIS MODULE MUST NOT BE FITTED INTO OPTION SLOT 3.

Option Slot 2 - Dual Relay Module

If option slot 2 is fitted with a dual relay output module, make connections as illustrated. This module has two independent relays, which share a common connection terminal. The contacts are rated at 2 amp resistive 120/240 VAC.

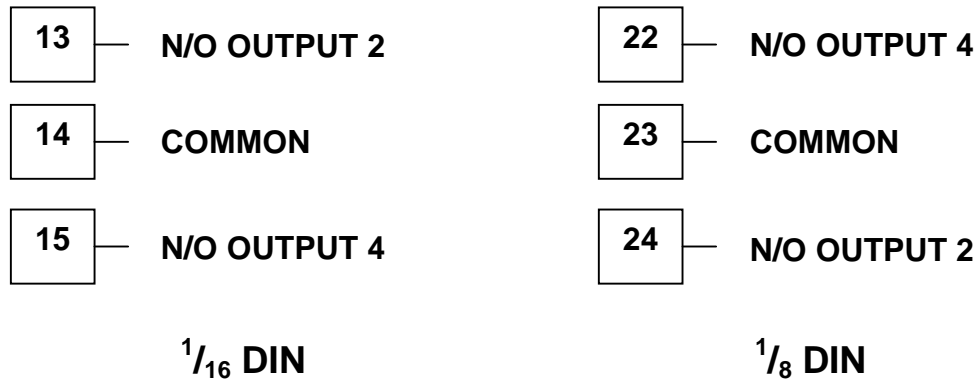

Figure 25. Option Slot 2 - Dual Relay Module

WARNING:

THIS MODULE MUST NOT BE FITTED INTO OPTION SLOT 3 ON 1/16 DIN INSTRUMENTS.

Option Slot 2 - Linear Voltage or mADC module

If option slot 2 is fitted with a DC linear output module, make connections as illustrated.

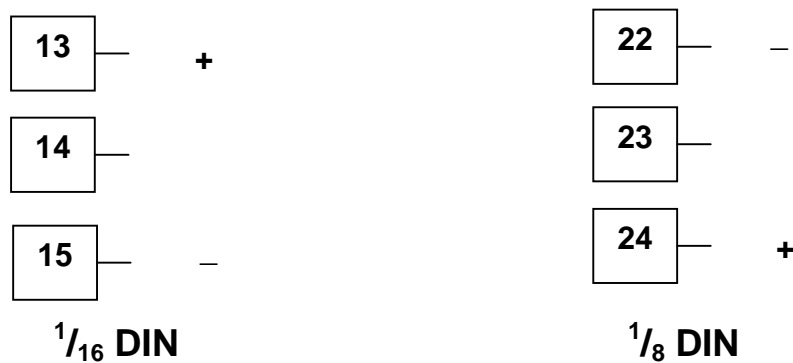

Figure 26. Option Slot 2 - Linear Voltage & mADC module

Option Slot 3 - Relay Module

If option slot 3 is fitted with a relay output module, make connections as illustrated. The contacts are rated at 2 amp resistive 120/240 VAC.



Figure 27. Option Slot 3 - Relay Module

Option Slot 3 - SSR Driver Module

If option slot 3 is fitted with an SSR driver output module, make connections as illustrated. The solid-state relay driver is a 0-10V DC signal; load impedance must be no less than 500 ohms. SSR driver outputs are not isolated from the signal input or other SSR driver outputs.

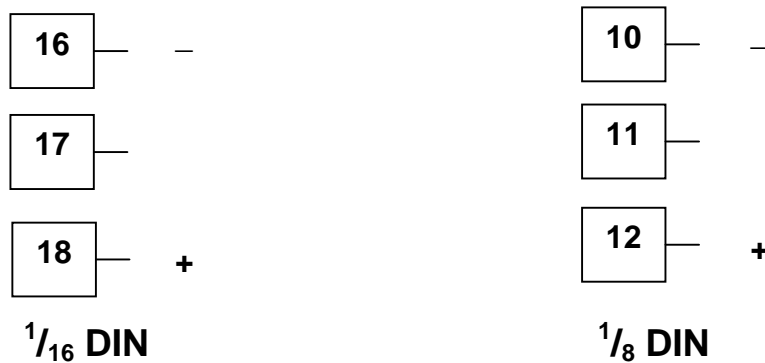

Figure 28. Option Slot 3 - SSR Driver Module

Option Slot 3 - Linear Voltage or mADC module

If option slot 3 is fitted with a DC linear output module, make connections as illustrated.

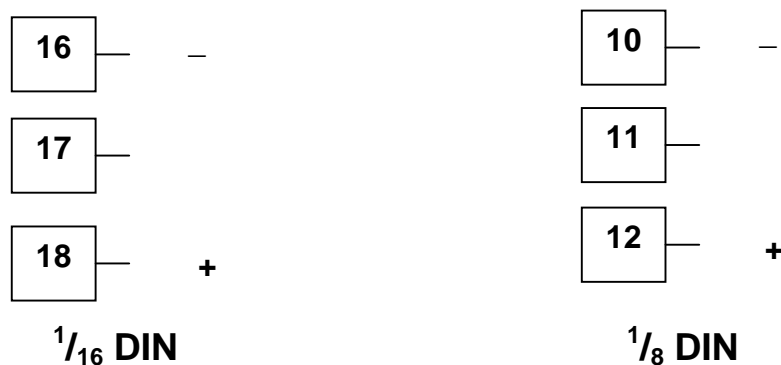

Figure 29. Option Slot 3 - Linear Voltage & mADC module

Option Slot 3 - Dual Relay Module

If option slot 3 is fitted with a dual relay output module, make connections as illustrated. This module has two independent relays, which share a common connection terminal. The contacts are rated at 2 amp resistive 120/240 VAC.

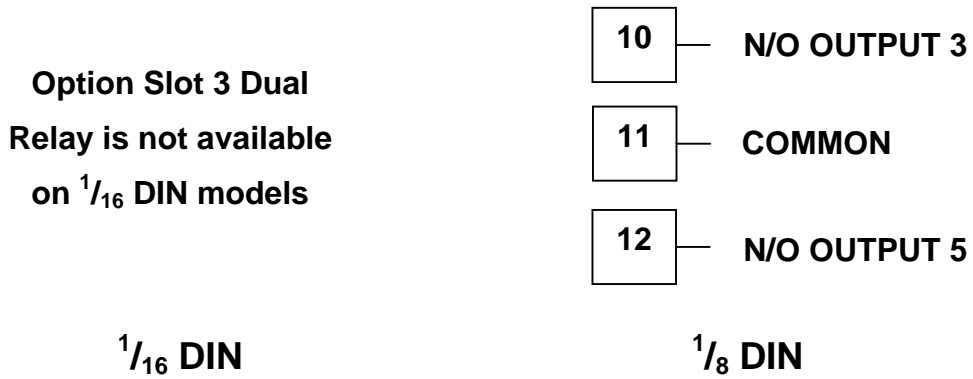

Figure 30. Option Slot 3 - Dual Relay Module

WARNING:

THIS MODULE MUST NOT BE FITTED INTO OPTION SLOT 3 ON 1/16 DIN INSTRUMENTS.

Option Slot 3 - Transmitter Power Supply Module

If option slot 3 is fitted with a transmitter power supply module, make connections as illustrated. The output is an unregulated 24V DC, 22mA supply.



Figure 31. Option Slot 3 - Transmitter Power Supply Module

WARNING:

THIS MODULE MUST NOT BE FITTED INTO OPTION SLOT 2.

Option Slot A Connections - RS485 Serial Communications Module

If option slot A is fitted with the RS485 serial communication module, connections are as illustrated. Carefully observe the polarity of the A (Rx/Tx +ve) and B (Rx/Tx -ve) connections.

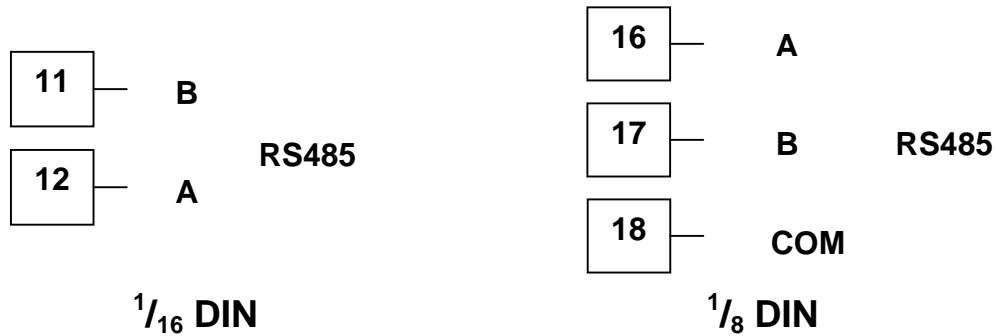

Figure 32. Option Slot A – RS485 Serial Communications Module

Option Slot A Connections - Digital Input Module

If a digital input module is fitted in option slot A, this may be connected to either voltage free contacts (e.g. switch or relay), or a TTL compatible voltage. Connections are shown below.



Figure 33. Option Slot A – Digital Input Module

Option Slot A Connections – Basic RSP

If option slot A is fitted with a basic remote setpoint module, input connections are as shown. For 1/8-DIN models it is recommended that the full RSP (Option Slot B) is used instead, as this has additional features and leaves option slot A free for other modules.



Figure 34. Option Slot A – Basic RSP Input Module

WARNING:

THIS MODULE MUST NOT BE FITTED IF FULL RSP HAS BEEN FITTED IN OPTION SLOT B.

Figure 35.

Option Slot B Connections – Digital Input 2

If option slot B is fitted with the Full RSP input module (see below), a secondary digital input is also provided. This may be connected to either the voltage free contacts of a switch or relay, or a TTL compatible voltage.

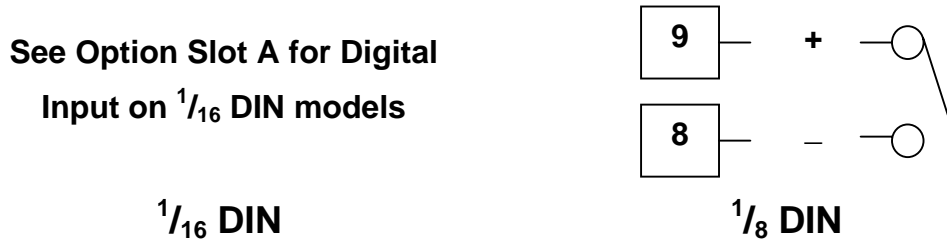

Figure 36. Option Slot B – Digital Input 2 Connections

Option Slot B Connections – 1/8 DIN Full RSP

If option slot B is fitted with full remote setpoint feature, input connections are as shown.

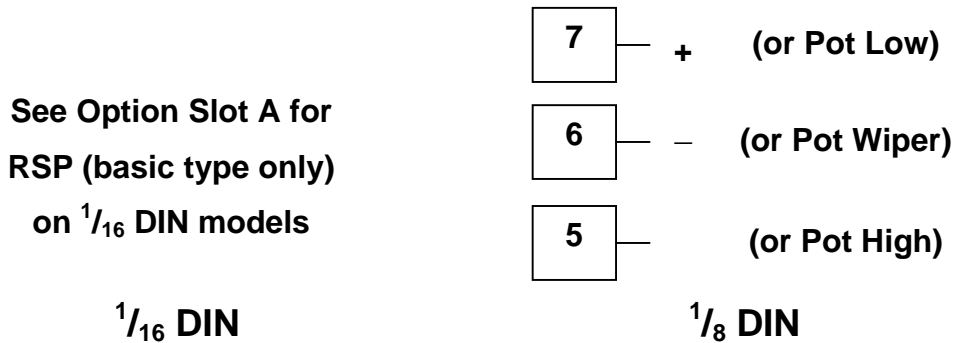

Figure 37. Option Slot B – Full Remote Setpoint Input Connections

WARNING:

IF THE FULL RSP MODULE HAS BEEN FITTED, THE BASIC RSP MUST NOT BE FITTED INTO OPTION SLOT A.

5 Powering Up

WARNING:

ENSURE SAFE WIRING PRACTICES ARE FOLLOWED

The instrument must be powered from a supply according to the wiring label on the side of the unit. The supply will be either 100 to 240V AC, or 24/48V AC/DC powered. Check carefully the supply voltage and connections before applying power.

CAUTION:

When powering up for the first time, disconnect the output connections.

Powering Up Procedure

At power up, a self-test procedure is automatically started, during which all LED segments and indicators are lit. At the first ever power up, or if option modules are changed, **Conf** will then be displayed, indicating configuration is required (refer to section 6). At all other times, the instrument returns to operator mode once the self-test procedure is complete.

Overview Of Front Panel

The illustration below shows a typical instrument front panel. Refer to the following table – Typical LED functions for a description of the front panel indicators. Each model in the range will vary slightly from the example shown.



Figure 38. Typical front panel and keys

Displays

Indicator models have a single line display, which normally shows the process variable value, and status indicators LED's for mode and alarm indication. Controllers are provided with a dual line display and LED indicators for mode, automatic tune, alarm and output status. The upper display shows the process variable value during normal operation, whilst the lower display shows the setpoint value. See the preceding diagram - Typical front panels.

LED Functions

Table 3. Typical LED functions

LED	Function
	ON indicates the Setup Mode has been entered <i>(This LED is labelled SET on indicator models)</i>
	FLASHING indicates the manual mode has been entered <i>(On indicator models this LED is labelled SET and flashes when in Configuration Mode)</i>
	ON indicates that Controller Self Tune mode is engaged
	FLASHING indicates that Controller Pre-Tune mode is engaged
	FLASHING indicates that an alarm condition is present
	FLASHES in unison with Time Proportioning Primary outputs, or for Current Proportioned outputs, ON indicates primary power is >0% <i>(On indicators this lights when the stored Max PV value is displayed)</i>
	FLASHES in unison with Time Proportioning Secondary outputs, or for Current Proportioned outputs, ON indicates primary power is >0% <i>(On indicators this lights when the stored Max PV value is displayed)</i>

Keypad

Each instrument in the range has either three or four switches, which are used to navigate through the user menus and make adjustment to the parameter values. See the preceding diagram - Typical front panels

6 Messages and Error Indications

The following displays are shown when an error occurs or a hardware change is detected.

Table 4. Error/Faults conditions

Error/Faults Conditions	Upper display	Lower Display (where fitted)	UDI1700 Units Display
Configuration & Setup is required. Seen at first turn on or if hardware configuration changed. Press SETUP to enter Configuration Mode, next press ▲ or ▼ to enter the unlock code number, then press SETUP to proceed. Configuration must be completed before return to operator mode is allowed ¹	CoTo (CoTo for 1 second, then ConF on Indicators)	ConF	C
Input more than 5% over-range ²	CHH	Normal Display	Normal Display
Input more than 5% under-range ³	CLL	Normal Display	Normal Display
Sensor Break. Break detected in the input sensor or wiring	OPEN	Normal Display	Normal Display
RSP input over-range	Normal Display	CHH **	n/a
RSP input under-range	Normal Display	CLL **	n/a
RSP Break. Break detected in the remote setpoint input	Normal Display	OPEN **	n/a
Option 1 module fault.	Err*	OPn1	1
Option 2 module fault.	Err*	OPn2	2
Option 3 module fault.	Err*	OPn3	3
Option A module fault.	Err*	OPnA	A
Option B module fault.	Err	OPnb	b

**** Note**

RSP break and over/under-range indication will be seen wherever the RSP value would be displayed.

¹ This feature does not guarantee correct configuration but only helps to ensure that the unit will be configured before use. Use of set-up mode is not enforced but may be essential for the users process.

² If the PV display exceeds **9999** before 5% over-range is reached, an over-range indication is given.

³ Indicators will allow up to 10% under-range on non-zero based Linear ranges. If the PV display is less than **-1999** before the % under-range is reached, an under-range indication is given.

7 Instrument Operation Modes

All instruments in the range share a similar user interface. On the DI1700 (single 4-digit display) the legend shown in the “Lower Display” column will be shown for approx 1 second before the “Upper Display” value is shown. For more details, refer to the mode tables below.

Table 5. Model Groups

Models	Description	Models	Description
DC1200 & DC1700	Controllers	DC120L	Limit Controller
DI1700	Indicator		

Select Mode

This mode is used to gain entry to each of the modes available in the instrument.

Entry into the Select Mode

Hold down and press in any mode to force the unit to enter Select Mode.

Navigating in Select Mode

Once in Select Mode, press or to select the required mode, then press to enter the chosen mode.

To prevent unauthorised entry to Configuration, Setup and Automatic Tuning modes, an unlock code is required. These are shown in the - Lock code values table.

Table 6. Select Mode Menus

Mode	Description	Upper/Main Display	Lower Display (or 1 st Legend)*	UDI1700 Units Display
Operator Mode	The Default Mode on power up used for normal operation.	OPt _r	SLCt	5
Set Up Mode	Used to tailor the instrument to the application, adjustment of tuning terms etc.	SEtP	SLCt	5
Configuration Mode	Used to configure the instrument for first time use or on re-installation.	ConF	SLCt	5
Product Information Mode	Used to check the hardware, firmware and manufacturing information of the instrument.	inFo	SLCt	5
Automatic Tune Mode	Used to invoke pre-tune or self-tune on controllers	Atun	SLCt	5

***Note:**

On the DI1700, this legend is shown for approx 1 second before the Main display value.

Unlock Codes

The **ULoc** screen is seen before entry is allowed to Configuration, Setup and Automatic Tuning modes.



An unlock code must be correctly selected using the  or  keys to enter the required mode. An incorrect entry results in a return to Select Mode. The value of the lock codes only can be changed from within the modes that they apply to.

Table 7. Lock Code – Entry and Default Values

Description	Upper/Main Display	Lower Display (or 1 st Legend)*	UDI1700 Units Display
Default values are: Automatic Tune Mode = 0 Set-up mode = 10 Configuration Mode = 20 .	0	ULoc	[



***Note:**

On the DI1700 (single line display), this legend is shown for approx 1 second before the Main display value.



Automatic Tune Mode

Automatic Tune Mode is selected when it is desired to use the Pre-tune and Self-tune facilities of the controller to assist the user in setting up Proportional band, Integral and Derivative parameter values. Refer to the following Automatic Tune Mode table.

Pre-tune can be used to set the Controllers PID parameters approximately. Self-tune may then be used to optimise the tuning. Pre-tune can be set to run automatically after every power-up using the Auto Pre-Tune **APT** parameter in Setup Mode.

The **AT** indicator will flash  while pre-tune is operating, and is continuously on  whilst Self-tune is operating. If both Pre-tune and Self-tune are engaged the **AT** indicator will flash until Pre-tune is finished, and is then continuously on.

Navigating in Automatic Tune Mode

Press  to select the next parameter in the table and  or  to set the value required.

Hold down  and press  to return to Select Mode.

Note:

If there is no key activity for 2 minutes the controller automatically returns to operator mode

Table 8. Automatic Tune Mode Parameters

Parameter	Upper Display Adjustment Range	Lower Display	Default Value	When Visible
Pre-tune	On or OFF . Indication remains OFF if Pre-Tune cannot be used at this time. This applies if: a). The setpoint is ramping b). The process variable is less than 5% of span from the setpoint c). The primary or secondary output proportional bands = 0	Ptun	OFF	Controller models only
Self-tune	On or OFF . Indication remains OFF if Self-Tune cannot be used at this time. This applies if either proportional band = 0.	Stun	OFF	Controller models only
Automatic tune mode lock code	0 to 9999	tLoc	0	Controller models only

Product Information Mode

This is a read only mode describing the instrument and the options fitted to it.

Navigating in the Product Information Mode

Press **SETUP** to view each parameter in turn.

Hold Down **SETUP** and press **▲** to return to Select Mode.

Note:

If there is no key activity for 2 minutes the controller automatically returns to operator mode

Table 9. Product Information Mode Parameters

Parameter	Possible Values	Upper/Main Display	Lower Display (or 1 st Legend)*	UDI1700 Units Display
Input type	Universal input	Un I	In I	t
Option 1 module type	No option fitted	nonE	OPn I	I
	Relay	rLY		
	SSR drive	SSr		
	Triac	tR I		
	Linear voltage / current output	L in		

Parameter	Possible Values	Upper/Main Display	Lower Display (or 1 st Legend)*	UDI1700 Units Display
Option 2 module type	No option fitted.	nonE	OPn2	2
	Relay	rLY		
	SSR drive	SSr		
	Triac	tr i		
	Linear voltage / current output	L in		
Option 3 module type	No option fitted.	nonE	OPn3	3
	Relay	rLY		
	SSR drive	SSr		
	Linear voltage / current output	L in		
	24V Transmitter power supply	dc24		
Auxiliary option A module type	No option fitted	nonE	OPnA	A
	RS485 comms	r485		
	Digital Input	d iG i		
	Basic remote setpoint input	rSP i		
Auxiliary option B module type	No option fitted	nonE	OPnb	Not Applicable
	Full RSP input and digital input 2	rSP i		
Firmware	Value displayed is firmware type number		FLW	F
Issue No.	Value displayed is firmware issue number		ISS	n
Product Rev Level	Value displayed is Product Revision Level.		PrL	r
Date of manufacture	Manufacturing date code (mmyy)		d0r7	d
Serial number 1	First four digits of serial number		Sn1	A
Serial number 2	Second four digits of serial number		Sn2	b
Serial number 3	Last four digits of serial number		Sn3	c

***Note:**

On the DI1700 (single line display), this legend is shown for approx 1 second before the Main display value.

Lock Code View

In the event that a lock code is forgotten, the instrument lock code values can be seen in the lock code view. In this view the codes are read only, the codes can be changed from the mode to which they apply.

Entry and Navigating in Lock Code View Mode

Press and together whilst the instrument is powering up until the **CLoc** display is shown.

Once in this mode

Press to step between lock codes.

Note:

If there is no key activity for 2 minutes the instrument returns to Operator Mode. To forcefully exit this view, switch off the instrument.

Table 10. Lock Code View Menu

Lock Code Name	Description	Upper/Main Display	Lower Display (or 1 st Legend)*	UDI1700 Units Display
Configuration Lock Code	Read only view of Configuration Lock Code.	Current Value	CLoc	C
Setup Lock Code	Read only view of Setup Mode Lock Code.	Current Value	SLoc	S
Automatic Tune Lock Code	Read only view of Automatic Tune Lock Code.	Current Value	tLoc	

***Note:**

On the DI1700 (single line display), this legend is shown for approx 1 second before the Main display value.

8 DC1200 & DC1700 Controllers – Model Group

The UDC1200 1/16 – DIN (48 x 48mm) and UDC1700 1/8 – DIN (96 x 48mm) controllers combine technical functionality, field flexibility and ease of use to give you the best in comprehensive process control. They offer similar functionality in two different case sizes.

- Heat/Cool operation
- Auto/Manual Tuning
- Two process alarms
- Ramping setpoint
- Loop alarm
- Remote or Dual setpoint selection
- RS485 Modbus and ASCII comms
- Configuration via PC

DC1200 & DC1700 Controllers - Configuration Mode

This mode is normally used only when the instrument is configured for the first time or when a major change is made to the controller characteristics. The Configuration Mode parameters must be set as required before adjusting parameters in Setup Mode, or attempting to use the instrument in an application.

Entry into the Configuration Mode



CAUTION:

Adjustments to these parameters should only be performed by personnel competent and authorised to do so.

Configuration is entered from Select Mode

Hold down  and press  to force the controller into the Select Mode.

then

Press  or  to navigate to the Configuration Mode option, then press .

Note:

Entry into this mode is security-protected by the Configuration Mode Lock Code. Refer to the Unlock Code section for more details.

Scrolling through Parameters and Values

Press  to scroll through the parameters (parameters are described below).

Note:

Only parameters that are applicable to the hardware options chosen will be displayed.

Changing Parameter Values

Press **SETUP** to navigate to the required parameter, then press or to set the value as required.

Once the value is changed, the display will flash to indicate that confirmation of the change is required. The value will revert back if not confirmed within 10 seconds.

Press to accept the change.

Or

Press **SETUP** to reject the change and to move onto the next parameter.

Hold down **SETUP** and press to return to Select Mode.

Note:

If there is no key activity for 2 minutes the instrument returns to the operator mode.

Table 11. DC1200 & DC1700 Configuration Mode Parameters

Parameter	Lower Display	Upper Display	Description	Default Value	When Visible
Input type and Range	InPt	bC	B type: 100 to 1824 °C	Jc	Always
		bF	B type: 211 to 3315 °F		
		Cc	C type: 0 to 2320 °C		
		Cf	C type: 32 to 4208 °F		
		Jc	J type: -200 to 1200 °C		
		Jf	J type: -328 to 2192 °F		
		J.C	J type: -128.8 to 537.7 °C with decimal point		
		J.F	J type: -199.9 to 999.9 °F with decimal point		
		Kc	K type: -240 to 1373 °C		
		Kf	K type: -400 to 2503 °F		
		K.C	K type: -128.8 to 537.7 °C with decimal point		
		K.F	K type: -199.9 to 999.9 °F with decimal point		
		Lc	L type: 0 to 762 °C		
		Lf	L type: 32 to 1403 °F		
L.C	L type: 0.0 to 537.7 °C with decimal point				
L.F	L type: 32.0 to 999.9 °F with decimal point				

Parameter	Lower Display	Upper Display	Description	Default Value	When Visible
		<i>NC</i>	N type: 0 to 1399 °C		
		<i>NF</i>	N type: 32 to 2551 °F		
		<i>rC</i>	R type: 0 to 1759 °C		
		<i>rF</i>	R type: 32 to 3198 °F		
		<i>SC</i>	S type: 0 to 1762 °C		
		<i>SF</i>	S type: 32 to 3204 °F		
		<i>tC</i>	T type: -240 to 400 °C		
		<i>tF</i>	T type: -400 to 752 °F		
		<i>t.C</i>	T type: -128.8 to 400.0 °C with decimal point		
		<i>t.F</i>	T type: -199.9 to 752.0 °F with decimal point		
		<i>P24C</i>	PtRh20% vs PtRh40%: 0 to 1850 °C		
		<i>P24F</i>	PtRh20% vs PtRh40%: 32 to 3362 °F		
		<i>PtC</i>	Pt100: -199 to 800 °C		
		<i>PtF</i>	Pt100: -328 to 1472 °F		
		<i>Pt.C</i>	Pt100: -128.8 to 537.7 °C with decimal point		
		<i>Pt.F</i>	Pt100: -199.9 to 999.9 °F with decimal point		
		<i>0_20</i>	0 to 20mA DC		
		<i>4_20</i>	4 to 20mA DC		
		<i>0_50</i>	0 to 50mV DC		
		<i>10.50</i>	10 to 50mV DC		
		<i>0_5</i>	0 to 5V DC		
		<i>1_5</i>	1 to 5V DC		
<i>0_10</i>	0 to 10V DC				
		2 to 10V DC			
Scale Range Upper Limit	<i>rUL</i>	Scale Range Lower Limit +100 to Range Max	Linear inputs = 1000 (°C/°F inputs = max range)	Always	
Scale Range Lower Limit	<i>rLL</i>	Range Min. to Scale range Upper Limit - 100	Linear = 0 (°C/°F = min range)	Always	

Parameter	Lower Display	Upper Display	Description	Default Value	When Visible
Decimal point position	dPos	0	Decimal point position in non-temperature ranges. 0 = XXXX 1 = XXX.X 2 = XX.XX 3 = X.XXX		InPt = mV, V or mA
		1			
		2			
		3			
Control Type	CTYP	SnGL	Primary control	SnGL	Always
		duAL	Primary and Secondary control (e.g. for heat & cool)		
Primary Output Control Action	Ctrl	rEu	Reverse Acting	rEu	Always
		dir	Direct Acting		
Alarm 1 Type	ALAI	P_H	Process High Alarm	P_H	Always
		P_Lo	Process Low Alarm		
		dE	Deviation Alarm		
		bAnd	Band Alarm		
		nonE	No alarm		
Process High Alarm 1 value*	PhAI	Range Min. to Range Max. <i>Parameter repeated in Setup Mode</i>		Range Max.	ALAI = P_H
Process Low Alarm 1 value*	PLAI	Range Min. to Range Max. <i>Parameter repeated in Setup Mode</i>		Range Min.	ALAI = P_Lo
Deviation Alarm 1 Value*	dAL1	±span from setpoint <i>Parameter repeated in Setup Mode</i>		S	ALAI = dE
Band Alarm 1 value*	bAL1	1 LSD to full span from setpoint. <i>Parameter repeated in Setup Mode</i>		S	ALAI = bAnd
Alarm 1 Hysteresis*	AHY1	1 LSD to 100% of span (in display units) on “safe” side of alarm point. <i>Parameter repeated in Setup Mode</i>			Always
Alarm 2 Type	ALAZ	As for alarm 1 type		P_Lo	Always
Process High Alarm 2 value*	PhAZ	Range Min. to Range Max. <i>Parameter repeated in Setup Mode</i>		Range Max.	ALAZ = P_H
Process Low Alarm 2 value*	PLAZ	Range Min. to Range Max. <i>Parameter repeated in Setup Mode</i>		Range Min.	ALAZ = P_Lo
Deviation Alarm 2 Value*	dAL2	±span from setpoint. <i>Parameter repeated in Setup Mode</i>		S	ALAZ = dE
Band Alarm 2 value*	bAL2	1 LSD to full span from setpoint. <i>Parameter repeated in Setup Mode</i>		S	ALAZ = bAnd
Alarm 2 Hysteresis*	AHY2	1 LSD to 100% of span (in display units) on “safe” side of alarm point. <i>Parameter repeated in Setup Mode</i>			Always
Loop Alarm Enable	LAEn	dISA (disabled) or EnAb (enabled)		dISA	Always

Parameter	Lower Display	Upper Display	Description	Default Value	When Visible
Loop Alarm Time*	<i>LAt</i>		1 sec to 99 mins. 59secs Only applies if primary proportional band = 0	99.59	<i>LAE_n</i> = <i>E_nAb</i>
Alarm Inhibit	<i>inh</i>	<i>nonE</i>	No alarms Inhibited	nonE	Always
		<i>AL1</i>	Alarm 1 inhibited		
		<i>AL2</i>	Alarm 2 inhibited		
		<i>both</i>	Alarm 1 and alarm 2 inhibited		
Output 1 Usage	<i>USE 1</i>	<i>Pr</i>	Primary Power	Pr	<i>OP_n 1</i> is not <i>nonE</i>
		<i>SEc</i>	Secondary Power		<i>Not linear</i>
		<i>A1_d</i>	Alarm 1, Direct Acting		<i>Not linear</i>
		<i>A1_r</i>	Alarm 1, Reverse Acting		<i>Not linear</i>
		<i>A2_d</i>	Alarm 2, Direct Acting		<i>Not linear</i>
		<i>A2_r</i>	Alarm 2, Reverse Acting		<i>Not linear</i>
		<i>LP_d</i>	Loop Alarm, Direct Acting		<i>Not linear</i>
		<i>LP_r</i>	Loop Alarm, Reverse Acting		<i>Not linear</i>
		<i>Or_d</i>	Logical Alarm 1 OR Alarm 2 Direct Acting		<i>Not linear</i>
		<i>Or_r</i>	Logical Alarm 1 OR Alarm 2 Reverse Acting		<i>Not linear</i>
		<i>Ar_d</i>	Logical Alarm 1 AND Alarm 2, Direct Acting		<i>Not linear</i>
		<i>Ar_r</i>	Logical Alarm 1 AND Alarm 2, Reverse Acting		<i>Not linear</i>
		<i>rEtS</i>	Retransmit SP Output		<i>Linear only</i>
		<i>rEtP</i>	Retransmit PV Output		<i>Linear only</i>
Linear Output 1 Range	<i>tYP 1</i>	<i>0_5</i>	0 to 5 V DC output 1	0_10	<i>OP_n 1</i> = <i>L_{in}</i>
		<i>0_10</i>	0 to 10 V DC output		
		<i>2_10</i>	2 to 10 V DC output		
		<i>0_20</i>	0 to 20 mA DC output		
		<i>4_20</i>	4 to 20 mA DC output		
Retransmit Output 1 Scale maximum	<i>ro IH</i>	- 1999 to 9999 Display value at which output will be maximum	Range max	<i>USE 1</i> = <i>rEtS</i> or <i>rEtP</i>	
Retransmit Output 1 Scale minimum	<i>ro IL</i>	- 1999 to 9999 Display value at which output will be minimum	Range min	<i>USE 1</i> = <i>rEtS</i> or <i>rEtP</i>	

Parameter	Lower Display	Upper Display	Description	Default Value	When Visible
Output 2 Usage	USE2	As for output 1		SEc if dual control selected else R2_d	OPn2 is not nonE
Linear Output 2 Range	LYP2	As for output 1		0_10	OPn2 = L in
Retransmit Output 2 Scale maximum	ro2H	- 1999 to 9999 Display value at which output will be maximum		Range max	USE2 = rEt5 or rEtP
Retransmit Output 2 Scale minimum	ro2L	- 1999 to 9999 Display value at which output will be minimum		Range min	USE2 = rEt5 or rEtP
Output 3 Usage	USE3	As for output 1		R1_d	OPn3 is not nonE
Linear Output 3 Range	LYP3	As for output 1		0_10	OPn3 = L in
Retransmit Output 3 Scale maximum	ro3H	- 1999 to 9999 Display value at which output will be maximum		Range max	USE3 = rEt5 or rEtP
Retransmit Output 3 Scale minimum	ro3L	- 1999 to 9999 Display value at which output will be minimum		Range min	USE3 = rEt5 or rEtP
Display Strategy	dISP	1, 2, 3, 4, 5 or 6 (see Operator Mode)		1	Always
Comms Protocol	Prot	ASC1	ASCII	r7bn	OPnA = r485
		r7bn	Modbus with no parity		
		r7bE	Modbus with Even Parity		
		r7bo	Modbus with Odd Parity		
Bit rate	bAud	1.2	1.2 kbps	4.8	OPnA = r485
		2.4	2.4 kbps		
		4.8	4.8 kbps		
		9.6	9.6 kbps		
		19.2	19.2 kbps		
Communications Address	Addr	1	Unique address assigned to the instrument in the range of 1 to 255 (Modbus), 1 to 99 (Ascii)	1	OPnA = r485

Parameter	Lower Display	Upper Display	Description	Default Value	When Visible
Communications Write Enable	CoEn	r_o	Read only. Comms writes ignored	r_w	Always
		r_w	Read / Write. Writing via Comms is possible		
Digital Input 1 Usage	d_i1	d_s1	Setpoint 1 / Setpoint 2 Select**	d_s1	OPnA = d_i1
		d_rs	Automatic / Manual Select**		
Digital Input 2 Usage	d_i2	d_s1	Setpoint 1 / Setpoint 2 Select**	d_rs	OPnb = rSPi
		d_rs	Automatic / Manual Select**		
		d_rs	Remote / Local Setpoint Select		
Remote Setpoint Input Range	rSPi	0_20	0 to 20mA DC input	0_10	OPnA or OPnb = rSPi
		4_20	4 to 20mA DC input		
		0_10	0 to 10V DC input		
		2_10	2 to 10V DC input		
		0_5	0 to 5V DC input		
		1_5	1 to 5V DC input		
		100	0 to 100mV DC input		
		Pot	Potentiometer ($\geq 2K\Omega$)		OPnb = rSPi
Remote Setpoint Upper Limit	rSPu	- 1999 to 9999 RSP value to be used when RSP input is at maximum.	Range max	OPnA = rSPi	
Remote Setpoint Lower Limit	rSPl	- 1999 to 9999 RSP value to be used when RSP input is at minimum.	Range min	OPnA = rSPi	
Remote Setpoint Offset	rSPo	Offset applied to RSP value. Constrained within Scale Range Upper Limit and Scale Range Lower Limit.	0	OPnA = rSPi	
Configuration Mode Lock Code	Loc	0 to 9999	20	Always	

***Note:**

Alarm parameters marked * are repeated in Setup Mode.

****Note:**

If d_i1 or d_i2 = d_s1 the remote setpoint input feature is disabled. The instrument uses the two internal setpoints (SP1 & SP2) instead.

If d_i1 and d_i2 are set to the same value, the status of digital input 2 will take precedence over digital input 1.

DC1200 & DC1700 Controllers – Setup Mode

This mode is normally selected only after Configuration Mode has been completed, and is used when a change to the process set up is required. It can affect the range of adjustments available in Operator Mode. Using the PC Configurator software, it is possible to configure an Extended Operator Mode. Setup Mode parameters are moved into Operator Mode, and these parameters appear after the normal Operator Mode screen sequence has been completed.

Note:

Entry into Setup Mode is security-protected by the Setup Mode lock code.

Entry into the Setup Mode



Hold down  and press  to enter the Select Mode

Press  or  to navigate to the Setup Mode option, then press  to enter Setup Mode.

Scrolling through Parameters & Values

Press  to scroll through the parameters (refer to the table below) and their values.

Changing Parameter Values

Press  to select the required parameter, then press  or  to set the value as required.

Once the displayed value is changed the effect is immediate. No confirmation of the change is required.

Note:

If there is no key activity for two minutes the instrument returns to the operator mode.

Table 12. DC1200 & DC1700 Set Up Mode Parameters

Parameter	Lower Display	Upper Display Adjustment Range	Default Value	When Visible
Input Filter Time constant	FILT	OFF, 0.5 to 100.0 secs in 0.5 sec increments	2.0	Always
Process Variable Offset	OFFS	±Span of controller	0	Always
Primary Power	PPUJ	The current Primary Output Power. Read Only.	N/A	Always
Secondary Power	SPLUJ	The current Secondary Output power. Read Only.	N/A	CTYP = duAL
Primary Output Proportional Band	Pb_P	0.0% (ON/OFF control) and 0.5% to 999.9% of input span.	10.0	Always
Secondary Output Proportional Band	Pb_S	0.0% (ON/OFF control) and 0.5% to 999.9% of input span.	10.0	CTYP = duAL
Automatic Reset (Integral Time Constant)	ARSt	1 sec to 99 mins 59 secs and OFF	5.00	Pb_P is not 0.0
Rate (Derivative Time Constant)	rAtE	00 secs to 99 mins 59 secs	1.15	Pb_P is not 0.0
Overlap/Deadband	OL	-20% to +20% of the sum of the Primary and Secondary Proportional Bands	0	Pb_P is not 0.0
Manual Reset (Bias)	bAS	0% to 100% (-100% to 100% if CTYP = duAL)	25	Pb_P is not 0.0
Primary Output ON/OFF Differential	dIFP	0.1% to 10.0% of input span (enter in % span)	0.5	Pb_P = 0.0
Secondary Output ON/OFF Differential	dIFS	0.1% to 10.0% of input span (enter in % span)	0.5	Pb_S = 0.0
Primary and Secondary Output ON/OFF Differential	dIFF	0.1% to 10.0% of input span (enter in % span)	0.5	Pb_P and Pb_S = 0.0
Setpoint Upper Limit	SPUL	Current Setpoint value to Scale Range Maximum	Range Max.	Always
Setpoint Lower limit	SPLL	Scale Range Minimum to current Setpoint value	Range Min	Always
Primary (Heat) Output Upper Power Limit	OPUL	0% to 100% of full power	100	Pb_P is not 0.0
Output 1 Cycle Time	CT1	0.5, 1, 2, 4, 8, 16, 32, 64, 128, 256 or 512 secs. Not applicable to linear outputs	32	USE 1 = Pr, or SEc or buS

Parameter	Lower Display	Upper Display Adjustment Range	Default Value	When Visible
Output 2 Cycle Time	CT2	0.5, 1, 2, 4, 8, 16, 32, 64, 128, 256 or 512 secs. Not applicable to linear outputs	32	USE2 = Pr , or SEc or buS
Output 3 Cycle Time	CT3	0.5, 1, 2, 4, 8, 16, 32, 64, 128, 256 or 512 secs. Not applicable to linear outputs	32	USE3 = Pr , or SEc or buS
Process High Alarm 1 value*	PHA1	Range Min. to Range Max.	Range Max.	ALA1 = P_H ,
Process Low Alarm 1 value*	PLA1	Range Min. to Range Max.	Range Min.	ALA1 = P_Lo
Deviation Alarm 1 Value*	dAL1	±span from setpoint	5	ALA1 = dE
Band Alarm 1 value*	bAL1	1 LSD to full span from setpoint.	5	ALA1 = bAnd
Alarm 1 Hysteresis*	AHY1	Up to 100% of span	1	Always
Process High Alarm 2 value*	PHA2	Range Min. to Range Max.	Range Max.	ALA2 = P_H ,
Process Low Alarm 2 value*	PLA2	Range Min. to Range Max.	Range Min.	ALA2 = P_Lo
Deviation Alarm 2 Value	dAL2	±span from setpoint	5	ALA2 = dE
Band Alarm 2 value*	bAL2	1 LSD to full span from setpoint.	5	ALA2 = bAnd
Alarm 2 Hysteresis*	AHY2	Up to 100% of span	1	Always
Loop Alarm Time*	LAET ,	1 sec to 99 mins. 59secs. Only applies if primary proportional band = 0	99 .59	LAEn = EnAb
Auto Pre-tune enable / disable	APt	d ,SA disabled or EnAb enabled	d ,SA	Always
Manual Control select enable / disable	POEn	d ,SA disabled or EnAb enabled	d ,SA	Always
Setpoint Select shown in Operator Mode, enable / disable	SSEn	d ,SA disabled or EnAb enabled	d ,SA	Slot A or B fitted with RSP module
Setpoint ramp shown in operator mode, enable / disable	SPr	d ,SA disabled or EnAb enabled	d ,SA	Always
SP Ramp Rate Value	rP	1 to 9999 units/hour or Off (blank)	Blank	Always

Parameter	Lower Display	Upper Display Adjustment Range	Default Value	When Visible
Setpoint Value	SP	Within scale range upper and lower limits	Range minimum	Always
Local Setpoint Value	LSP _LSP or ≡LSP	Within scale range upper and lower limits. _ or ≡ before the legend indicates if this is the currently active SP	Range minimum.	OPnA or OPnb = rSP ,
Setpoint 1 Value	SP 1 _SP 1 or ≡SP 1	Within scale range upper and lower limits. _ or ≡ before the legend indicates if this is the currently active SP	Range minimum.	d IG 1 or d IG2 = d IS 1
Setpoint2 Value	SP2 _SP2 or ≡SP2	Within scale range upper and lower limits. _ or ≡ before the legend indicates if this is the currently active SP	Range minimum.	d IG 1 or d IG2 = d IS 1
Set-up Lock Code	SLoc	0 to 9999	10	Always
**First Operator mode displays follows.				

Note:

*Alarm parameters marked * are repeated in Configuration Mode.*

Note:

***Once the complete list of Set Up Mode parameters has been displayed, the first Operator Mode display is shown without exiting from Set Up Mode. Display seen is dependant on the Display Strategy and status of Auto/Manual mode selection.*

DC1200 & DC1700 Controllers - Operator Mode

This is the mode used during normal operation of the instrument. It can be accessed from Select Mode, and is the usual mode entered at power-up. The available displays are dependent upon whether Dual or Remote Setpoint modes are being used, whether Setpoint Ramping is enabled and the setting of the Display Strategy parameter in Configuration Mode.

WARNING:

IN NORMAL OPERATION, THE OPERATOR MUST NOT REMOVE THE CONTROLLER FROM ITS HOUSING OR HAVE UNRESTRICTED ACCESS TO THE REAR TERMINALS, AS THIS WOULD PROVIDE POTENTIAL CONTACT WITH HAZARDOUS LIVE PARTS.

CAUTION:



Set all Configuration Mode parameters and Set Up Mode parameters as required before starting normal operations.

DC1200 & DC1700 Controllers – Extended Operator Mode

Using the PC configuration software, it is possible to extend the Operator Mode displays available by adding parameters from Setup Mode. When an extended Operator Mode is configured the additional parameters are available after the standard operator displays.

Navigating in Operator Mode

Press  to move between displays.

When a display value can be adjusted, use  or  to change its value.

Note:

The operator can freely view the parameters in this mode, but alteration depends on the settings in the Configuration and Set Up Modes. All parameters in Display strategy 6 are read only, and can only be adjusted via Setup mode.

Table 13. DC1200 & DC1700 Operator Mode Displays

Upper Display	Lower Display	When Visible	Description
PV Value	Active SP Value	Display strategy 1 and 2. <i>(Initial Screen)</i>	Process Variable and target value of currently selected Setpoint. <i>Local SP is adjustable in Strategy 2</i>
PV Value	Actual SP Value	Display strategy 3 and 6 <i>(Initial Screen)</i>	Process Variable and actual value of selected Setpoint (e.g. ramping SP value). <i>Read only</i>
PV Value	<i>Blank</i>	Display strategy 4. <i>(Initial Screen)</i>	Shows Process Variable. <i>Read only</i>
Actual SP Value	<i>Blank</i>	Display strategy 5. <i>(Initial Screen)</i>	Shows target value of currently selected Setpoint. <i>Read only</i>

Upper Display	Lower Display	When Visible	Description	
SP Value	SP	Display strategy 1, 3, 4, 5 and 6 if Digital Input is not d i l in config mode and RSP is not fitted	Target value of Setpoint. <i>Adjustable except in Strategy 6</i>	
SP1 Value	SP 1 or _SP 1	If Digital Input is set for dual SP (d i l in config mode).	Target value of Setpoint 1. _SP 1 means SP1 is selected as the active Setpoint. <i>Adjustable except in Strategy 6</i>	
SP2 Value	SP 2 or _SP 2	If Digital Input is set for dual SP (d i l in config mode).	Target value of Setpoint 2. _SP 2 means SP2 is selected as the active Setpoint. <i>Adjustable except in Strategy 6</i>	
Local Setpoint Value	LSP _LSP or ≡LSP	If Remote Setpoint Input is fitted and Digital Input is not d i l in config mode	Target value of Local Setpoint. _LSP means the local setpoint is selected as the active SP (if the digital input has been overridden, the ≡ character is lit instead). <i>Adjustable except in Strategy 6</i>	
Remote Setpoint Value	rSP _rSP or ≡rSP	If Remote Setpoint Input is fitted and Digital Input is not d i l in config mode	Target value of Remote Setpoint. _rSP means the remote setpoint is selected as the active SP (if the digital input has been overridden, the ≡ character is lit instead). <i>Read only</i>	
LSP rSP or d i l	SPS	If Remote Setpoint Input is fitted, Digital Input is not d i l in config mode and SSEn is enabled in Setup mode	Setpoint Select. Selects between Local or Remote Setpoints. LSP = local SP, rSP = remote SP, d i l = selection via digital input (if configured). <i>Note: LSP or rSP will override the digital input (active SP indication changes to ≡)</i> <i>Adjustable except in Strategy 6</i>	
Actual SP Value	SP rP	If a Ramping Setpoint is in use (rP not <i>Blank</i>).	Actual value of selected Setpoint (e.g. ramping SP value). <i>Read only</i>	
SP Ramp Rate Value	rP	If SP r (ramping SP) is enabled in Setup mode.	Setpoint ramping rate, in units per hour. Set to <i>Blank</i> (higher than 9999) to turn off ramping. <i>Adjustable except in Strategy 6</i>	
Active Alarm Status	ALSt	When any alarm is active.  ALM indicator will also flash	Upper display shows which alarm(s) are active. Inactive alarms are blank	
			1	Alarm 1 Active
			2	Alarm 2 Active
			L	Loop Alarm Active



Note:

When an extended Operator Mode is configured the additional parameters are available after the above parameters. Extended Operator Mode parameters can only be configured using the PC software.

Adjusting the Local Setpoint(s)

Setpoints can be adjusted within the limits set by the Setpoint Upper and Lower Limit parameters in Setup. Operator Mode adjustment of Setpoint is not possible if Display Strategy 6 has been selected on Configuration Mode.

Press  to select the adjustable setpoint display

Press  or  to adjust the setpoint to the required value.

Adjusting the Setpoint Ramp Rate

The ramp rate may be adjusted in the range 1 to 9999 and OFF. Increasing the ramp rate value beyond 9999 will cause the upper display to go blank and setpoint ramping to be switched OFF. Setpoint ramping can be resumed by decreasing the ramp rate to 9999 or less.

Press  to select the adjustable setpoint display

Press  or  to adjust the setpoint to the required value.

WARNING:



THE SETPOINT RAMP FEATURE DISABLES THE PRE-TUNE FACILITY. THE SELF-TUNE FACILITY WILL COMMENCE ONLY AFTER THE SETPOINT HAS COMPLETED THE RAMP.

Manual Control Mode

To allow manual control to be selected in Operator Mode, **PoEn** must be enabled in Set Up Mode. The MAN indicator will flash continually in Manual Mode.

Selecting/deselecting Manual Control Mode

Press the  key to toggle between Automatic and Manual control.

Press  or  to adjust the output power to the required value.

CAUTION:

The Manual Mode power level can be adjusted from 0 to 100% (-100 to +100% for dual output). It is not restricted by the Output Power Limit parameter **OPuL.**

Note:

*Disabling **PoEn** in Set Up Mode whilst manual control mode is active will lock the controller into manual mode. Pressing the Auto/Man key will no longer cause a return to automatic control. To exit from Manual Mode, **PoEn** must temporarily be re-enabled.*

DC1200 & DC1700 Controllers – Serial Communications Parameters

The Modbus parameter addresses, and the possible ASCII message types and parameter indents for the DC1200 & DC1700 are detailed below. RO indicates a parameter is read only, R/W indicates it can also be written to. Communications writes will not implemented if the Communications Write Parameter is disabled. Refer to the Modbus and ASCII Communications sections of this manual for details of the protocols used.

Bit Parameters

Bit parameters are not applicable to the ASCII protocol.

Table 14. DC1200 & DC1700 Communications - Bit Parameters

Parameter	Modbus Parameter No.		Notes
Communication Write Status	1	RO	1 = Write Enabled, 0 = Write Disabled. A negative acknowledgement (exception code 3) is sent to write commands if communications writes are disabled
Auto / Manual	2	R/W	1 = Manual Control, 0 = Automatic Control
Self Tune	3	R/W	1 = Activate(d), 0 = Dis-engage(d)
Pre tune	4	R/W	1 = Activate(d), 0 = Dis-engage(d)
Alarm 1 Status	5	RO	1 = Active, 0 = Inactive
Alarm 2 Status	6	RO	1 = Active, 0 = Inactive
Setpoint Ramping	7	R/W	1 = Enable(d), 0 = Disable(d)
Loop Alarm Status	10	R/W	1 = Active/Enable, 0 = Inactive/Disable
Loop Alarm	12	R/W	Read to get loop alarm status. Write 0/1 to disable/enable.
Digital Input 2	13	RO	State of Option B digital input. (RSP models only).

To set the bit value to 1 write FF, to set the bit value to 0 write 00. Refer to Function Code 05 in the Modbus Communications section.

Word Parameters

Table 15. DC1200 & DC1700 Communications - Word Parameters

Parameter	Modbus Parameter No.		ASCII Ident & Message Types		Notes
Process Variable	1	RO	M Type 2	RO	Current value of PV.
					If under-range = 62976 (<??>5 ASCII)
					If over-range = 63232 (<??>0 ASCII)
					If Sensor break = 63488 (ASCII = n/a)
Setpoint	2	R/W	S Type 2 Type 3/4	RO R/W	Value of currently selected setpoint. (Target setpoint if ramping). Parameter is read only if the current setpoint is RSP.
Output Power	3	R/W	W Type 2 Type 3/4	RO R/W	0% to 100% for single output; -100% to +100% for dual output control. Read Only if not in manual control.

Parameter	Modbus		ASCII Ident & Message Types		Notes
	Parameter No.				
Deviation	4	RO	V Type 2	RO	Difference between Process Variable and Setpoint (value = PV-SP)
Secondary Proportional Band	5	R/W	U Type 2, 3/4	R/W	Adjustable 0.0% to 999.9% of input span. Read only when Self-Tuning.
Primary Proportional Band	6	R/W	P Type 2, 3/4	R/W	Adjustable 0.0% to 999.9% of input span. Read only when Self-Tuning.
Direct / Reverse Acting	7	R/W			1 = Direct Acting, 0 = Reverse
Automatic Reset Time (or Loop Alarm Time)	8	R/W	I Type 2, 3/4	R/W	Integral Time Constant value. (or Loop Alarm Time value in ON/OFF control mode if Loop Alarm Enabled) Read only if Self-Tuning. ASCII range: 0 to 99m 59sec (99.59) Modbus range: 0 to 5999
Rate	9	R/W	D Type 2, 3/4	R/W	Derivative Time Constant value. Read only if Self-Tuning. ASCII range: 0 to 99m 59secs. (99.59) Modbus range: 0 to 5999
Output 1 Cycle time	10	R/W	N Type 2 Type 3/4	RO R/W	0.5, 1, 2, 4, 8, 16, 32, 64,128, 256 or 512 seconds.
Scale Range Lower Limit	11	R/W	H Type 2 Type 3/4	RO R/W	Lower limit of scaled input range
Scale Range Upper Limit	12	R/W	G Type 2 Type 3/4	RO R/W	Upper limit of scaled input range
Alarm 1 Value	13	R/W	C Type 2, 3/4	R/W	Alarm 1 active at this level
Alarm 2 Value	14	R/W	E Type 2, 3/4	R/W	Alarm 2 active at this level
Manual Reset	15	R/W	J Type 2, 3/4	R/W	Bias value. 0% to 100% for single control output or -100% to +100% for dual outputs
Overlap / Deadband	16	R/W	K Type 2, 3/4	R/W	20% to +20% of PB_P + PB_S ; Negative value = Deadband Positive value = Overlap
On / Off Differential	17	R/W	F Type 2, 3/4	R/W	0.1% to 10.0% of input span Used for Primary output on/off differential and for combined Primary and Secondary on/off differential.
Decimal Point Position	18	R/W	Q Type 2 Type 3/4	RO R/W	0 = xxxx 1 = xxx.x 2 = xx.xx 3 = x.xxx Read only if not Linear Input.

Parameter	Modbus		ASCII Ident & Message Types		Notes
	Parameter No.				
Output 2 Cycle Time.	19	R/W	O Type 2 Type 3/4	RO R/W	0.5, 1, 2, 4, 8, 16, 32, 64,128, 256 or 512 seconds.
Primary Output Power Limit	20	R/W	B Type 2 Type 3/4	RO R/W	Safety power limit; 0 to 100 %.
Actual Setpoint	21	RO			Current (ramping) value of selected setpoint.
Setpoint Upper Limit	22	R/W	A Type 2 Type 3/4	RO R/W	Maximum setpoint value. Current SP to Input Range Maximum
Setpoint Lower Limit	23	R/W	T Type 2 Type 3/4	RO R/W	Minimum setpoint value. Current SP to Input Range Minimum
Setpoint Ramp Rate	24	R/W	^ Type 2 Type 3/4	RO R/W	0 = Off, 1 to 9999 increments / hour. Dec Point position as for input range.
Input Filter Time Constant	25	R/W	m Type 2, 3/4	R/W	0 to 100 seconds
Process Value Offset	26	R/W	v Type 2 Type 3/4	RO R/W	Modified PV = Actual PV + PV Offset. Limited by Scale Range Maximum and Scale Range Minimum.
Re-transmit Output Maximum	27	R/W	[Type 2, 3/4	R/W	Maximum scale value for retransmit output, 1999 to 9999. This parameter applies to the first re-transmit output fitted (see also Modbus parameters 2214, 2224 & 2234).
Re-transmit Output Minimum	28	R/W	\ Type 2, 3/4	R/W	Minimum scale value for retransmit output, 1999 to 9999. This parameter applies to the first re-transmit output fitted (see also Modbus parameters 2215, 2225 & 2235).
Setpoint 2	29	R/W			Value of Setpoint 2
Remote Setpoint	30	RO			Value of Remote Setpoint. Returns 0FFFFhex if RSP not fitted.
Remote Setpoint Offset	31	R/W	~ Type 2, 3/4	R/W	Modified RSP = Actual RSP + RSP Offset. Limited by Scale Range Maximum and Scale Range Minimum.
Alarm 1 Hysteresis	32	R/W			0 to 100% of span
Alarm 2 Hysteresis	33	R/W			0 to 100% of span
Setpoint 1	34	R/W			Value of Setpoint 1
Setpoint Select	35	RO			Shows which is the currently selected active setpoint 1 = SP1 or LSP 2 = SP2 100hex = RSP

Parameter	Modbus Parameter No.		ASCII Ident & Message Types		Notes																		
Controller commands			Z Type 3/4	R/W	<p>Only Type 3 / 4 ASCII messages are allowed with this parameter. The {DATA} field must be one of eight five-digit numbers. The commands corresponding to the {DATA} field value are:</p> <ul style="list-style-type: none"> 00010 = Activate Manual Control 00020 = Activate Automatic Control 00030 = Activate the Self-Tune 00040 = De-activate the Self-Tune 00050 = Request Pre-Tune 00060 = Abort Pre-Tune 00130 = Activate Loop Alarm 00140 = De-activate Loop Alarm 																		
Controller Status			L Type 2	RO	<table border="1"> <thead> <tr> <th>Bit</th> <th>Meaning</th> </tr> </thead> <tbody> <tr> <td>0</td> <td>Alarm 1 status. 0 = activated, 1 = safe</td> </tr> <tr> <td>1</td> <td>Alarm 2 status. 0 = activated, 1 = safe</td> </tr> <tr> <td>2</td> <td>Self-Tune status. 0 = disabled 1 = activated</td> </tr> <tr> <td>3</td> <td>Change Indicator. 1 = A parameter other than controller status, PV or Output power has been changed since the last time the status word was read.</td> </tr> <tr> <td>4</td> <td>Comms write status: 0 = disabled 1 = enabled.</td> </tr> <tr> <td>5</td> <td>A/M control. 0 = disabled 1 = enabled</td> </tr> <tr> <td>7</td> <td>Pre-tune status. 0 = disabled 1 = enabled.</td> </tr> <tr> <td>8</td> <td>Loop alarm status. 0 = activated, 1 = safe.</td> </tr> </tbody> </table>	Bit	Meaning	0	Alarm 1 status. 0 = activated, 1 = safe	1	Alarm 2 status. 0 = activated, 1 = safe	2	Self-Tune status. 0 = disabled 1 = activated	3	Change Indicator. 1 = A parameter other than controller status, PV or Output power has been changed since the last time the status word was read.	4	Comms write status: 0 = disabled 1 = enabled.	5	A/M control. 0 = disabled 1 = enabled	7	Pre-tune status. 0 = disabled 1 = enabled.	8	Loop alarm status. 0 = activated, 1 = safe.
					Bit	Meaning																	
					0	Alarm 1 status. 0 = activated, 1 = safe																	
					1	Alarm 2 status. 0 = activated, 1 = safe																	
					2	Self-Tune status. 0 = disabled 1 = activated																	
					3	Change Indicator. 1 = A parameter other than controller status, PV or Output power has been changed since the last time the status word was read.																	
					4	Comms write status: 0 = disabled 1 = enabled.																	
					5	A/M control. 0 = disabled 1 = enabled																	
					7	Pre-tune status. 0 = disabled 1 = enabled.																	
8	Loop alarm status. 0 = activated, 1 = safe.																						
Scan Table] Type 2	RO	<p>Reads back main process values. Response is: L{N}25aaaaabbbbbbccccddddeeeeeA* where:</p> <ul style="list-style-type: none"> aaaaa = Actual Setpoint value bbbbbb = Process Variable value cccccc = Primary PID Power value dddddd = Secondary PID Power value eeeeee = Controller Status (see above) 																		
Equipment ID	122	RO			A four digit ident number 17D4hex																		

Parameter	Modbus		ASCII Ident & Message Types		Notes	
	Parameter No.					
Serial Number Low	123	RO			Digits aaaa	Unit serial number. Format aaaa bbbb cccc, (12 BCD digits).
Serial Number Mid	124	RO			Digits bbbb	
Serial Number High	125	RO			Digits cccc	
Date of manufacture	126	RO			Manufacturing date code as an encoded binary number. E.g. 0403 for April 2003 is returned as 193hex	
Product Revision Level	129	RO			Low Byte	Alpha part of PRL. E.g. A = 01hex
					High Byte	Numeric part of PRL. E.g. 13 = 0Dhex
Firmware Version	130	RO			Bits	Meaning
					0 - 4	Revision number (1,2...)
					5 - 9	Alpha version (A=0, B=1...)
					10 - 15	Numeric version (starting from 121 = 0)
Input status	133	RO			Input status. Read Only. Bit 0: Sensor break flag Bit 1: Under-range flag Bit 2: Over-range flag	
Remote Setpoint Lower Limit	2123	R/W	Y	R/W	RSP value to be used when RSP input is at minimum. -1999 to 9999	
Remote Setpoint Upper Limit	2124	R/W	X	R/W	RSP value to be used when RSP input is at minimum. -1999 to 9999	
Option Slot 1 Re-transmit output Maximum	2214	R/W			Maximum scale value for retransmit output in slot 1, -1999 to 9999.	
Option Slot 1 Re-transmit output Minimum	2215	R/W			Minimum scale value for retransmit output in slot 1, -1999 to 9999.	
Option Slot 2 Re-transmit output Maximum	2224	R/W			Maximum scale value for retransmit output in slot 2, -1999 to 9999.	
Option Slot 2 Re-transmit output Minimum	2225	R/W			Minimum scale value for retransmit output in slot 2, -1999 to 9999.	
Option Slot 3 Re-transmit output Maximum	2234	R/W			Maximum scale value for retransmit output in slot 3, -1999 to 9999.	
Option Slot 3 Re-transmit output Minimum	2235	R/W			Minimum scale value for retransmit output in slot 3, -1999 to 9999.	

Note:

Some of the parameters that do not apply for a particular configuration will accept reads and writes (e.g. attempting to scale a Linear output which has not been fitted). Read only parameters will return an exception if an attempt is made to write values to them.

9 DC120L Limit Controller

Limit Controllers protect processes that could become hazardous under fault conditions, by shutting down the process at a preset level. The DC120L is a 1/16 DIN (48 x 48mm) size Limit Controller.

- High or low trip
- Exceed & relay trip indicators
- RS485 Modbus and ASCII comms
- PV retransmit option
- 5 amp latching limit relay
- 2 Annunciators or process alarms
- Remote reset option
- Configuration via PC

DC120L Limit Controller - Configuration Mode

This mode is normally used only when the instrument is configured for the first time or when a major change is made to the controller characteristics. The Configuration Mode parameters must be set as required before adjusting parameters in Setup Mode, or attempting to use the instrument in an application.

Entry into the Configuration Mode



CAUTION:

Adjustments to these parameters should only be performed by personnel competent and authorised to do so.

Configuration is entered from Select Mode

Hold down  and press  to force the controller into the Select Mode.

then

Press  or  to navigate to the Configuration Mode option, then press .

Note:

Entry into this mode is security-protected by the Configuration Mode Lock Code. Refer to the Unlock Code section for more details.



Scrolling through Parameters and Values

Press  to scroll through the parameters (parameters are described below).

Note:

Only parameters that are applicable to the hardware options chosen will be displayed.

Changing Parameter Values

Press **SETUP** to navigate to the required parameter, then press  or  to set the value as required.

Once the value is changed, the display will flash to indicate that confirmation of the change is required. The value will revert back if not confirmed within 10 seconds.

Press **RESET** to accept the change.

Or

Press **SETUP** to reject the change and to move onto the next parameter.

Hold down **SETUP** and press  to return to Select Mode.

Note:

If there is no key activity for 2 minutes, the instrument returns to the operator mode.

Table 16. DC120L Configuration Mode Parameters

Parameter	Lower Display	Upper Display	Description	Default Value	When Visible
Input type and Range	InPt	bC	B type: 100 to 1824 °C	Jc	Always
		bF	B type: 211 to 3315 °F		
		cC	C type: 0 to 2320 °C		
		cF	C type: 32 to 4208 °F		
		Jc	J type: -200 to 1200 °C		
		JF	J type: -328 to 2192 °F		
		J.C	J type: -128.8 to 537.7 °C with decimal point		
		J.F	J type: -199.9 to 999.9 °F with decimal point		
		Kc	K type: -240 to 1373 °C		
		KF	K type: -400 to 2503 °F		
		K.C	K type: -128.8 to 537.7 °C with decimal point		
		K.F	K type: -199.9 to 999.9 °F with decimal point		
		Lc	L type: 0 to 762 °C		
		LF	L type: 32 to 1403 °F		
		L.C	L type: 0.0 to 537.7 °C with decimal point		
L.F	L type: 32.0 to 999.9 °F with decimal point				

Parameter	Lower Display	Upper Display	Description	Default Value	When Visible
		<i>nC</i>	N type: 0 to 1399 °C		
		<i>nF</i>	N type: 32 to 2551 °F		
		<i>rC</i>	R type: 0 to 1759 °C		
		<i>rF</i>	R type: 32 to 3198 °F		
		<i>sC</i>	S type: 0 to 1762 °C		
		<i>sF</i>	S type: 32 to 3204 °F		
		<i>tC</i>	T type: -240 to 400 °C		
		<i>tF</i>	T type: -400 to 752 °F		
		<i>t.C</i>	T type: -128.8 to 400.0 °C with decimal point		
		<i>t.F</i>	T type: -199.9 to 752.0 °F with decimal point		
		<i>P24C</i>	PtRh20% vs PtRh40%: 0 to 1850 °C		
		<i>P24F</i>	PtRh20% vs PtRh40%: 32 to 3362 °F		
		<i>PtC</i>	Pt100: -199 to 800 °C		
		<i>PtF</i>	Pt100: -328 to 1472 °F		
		<i>Pt.C</i>	Pt100: -128.8 to 537.7 °C with decimal point		
		<i>Pt.F</i>	Pt100: -199.9 to 999.9 °F with decimal point		
		<i>0_20</i>	0 to 20mA DC		
		<i>4_20</i>	4 to 20mA DC		
		<i>0_50</i>	0 to 50mV DC		
		<i>10_50</i>	10 to 50mV DC		
		<i>0_5</i>	0 to 5V DC		
		<i>1_5</i>	1 to 5V DC		
		<i>0_10</i>	0 to 10V DC		
			2 to 10V DC		
Scale Range Upper Limit	<i>rUL</i>		Scale Range Lower Limit +100 to Range Max	Linear inputs = 1000 (°C/°F inputs = max range)	Always
Scale Range Lower Limit	<i>rLL</i>		Range Min. to Scale range Upper Limit - 100	Linear = 0 (°C/°F = min range)	Always

Parameter	Lower Display	Upper Display	Description	Default Value	When Visible
Decimal point position	dPo5	0	Decimal point position in non-temperature ranges. 0 = XXXX 1 = XXX.X 2 = XX.XX 3 = X.XXX	1	InPt = mV, V or mA
		1			
		2			
		3			
Process Variable Offset	OFF5	±Span of controller(see CAUTION note at end of section)		0	Always
Limit Action	Ctrl	H ,	High Limit. <i>Limit relay is energised when process "safe" (PV < Limit Setpoint)</i>	H ,	Always
		Lo	Low Limit. <i>Limit relay is energised when process "safe" (PV > Limit Setpoint)</i>		
Setpoint Upper Limit	SPUL	Current Setpoint value to Scale Range Maximum		Range Max.	Always
Setpoint Lower Limit	SPLL	Scale Range Minimum to current Setpoint value		Range Min	Always
Alarm 1Type	ALA 1	P_H ,	Process High Alarm	P_H ,	Always
		P_Lo	Process Low Alarm		
		dE	Deviation Alarm		
		bAnd	Band Alarm		
		nonE	No alarm		
Process High Alarm 1 value*	PHA 1	Range Min. to Range Max. <i>Parameter repeated in Setup Mode</i>		Range Max.	ALA 1 = P_H ,
Process Low Alarm 1 value*	PLA 1	Range Min. to Range Max <i>Parameter repeated in Setup Mode</i>		Range Min.	ALA 1 = P_Lo
Deviation Alarm 1 Value*	dAL 1	±span from setpoint <i>Parameter repeated in Setup Mode</i>		5	ALA 1 = dE
Band Alarm 1 value*	bAL 1	1 LSD to full span from setpoint. <i>Parameter repeated in Setup Mode</i>		5	ALA 1 = bAnd
Alarm 1 Hysteresis*	AHY 1	1 LSD to 100% of span (in display units) on "safe" side of alarm point. <i>Parameter repeated in Setup Mode</i>		1	Always
Alarm 2 Type	ALA2	As for alarm 1 type		P_Lo	Always
Process High Alarm 2 value*	PHA2	Range Min. to Range Max. <i>Parameter repeated in Setup Mode</i>		Range Max.	ALA2 = P_H ,
Process Low Alarm 2 value*	PLA2	Range Min. to Range Max. <i>Parameter repeated in Setup Mode</i>		Range Min.	ALA2 = P_Lo
Deviation Alarm 2 Value*	dAL2	±span from setpoint. <i>Parameter repeated in Setup Mode</i>		5	ALA2 = dE

Parameter	Lower Display	Upper Display	Description	Default Value	When Visible
Band Alarm 2 value*	bAL2	1 LSD to full span from setpoint. <i>Parameter repeated in Setup Mode</i>		5	AL2 = bAnd
Alarm 2 Hysteresis*	AHY2	1 LSD to 100% of span (in display units) on "safe" side of alarm point. <i>Parameter repeated in Setup Mode</i>		1	Always
Output 2 Usage	USE2	LrT	Limit Output Relay	A2_d when OPn2 is not linear output type, rEtP if OPn2 is linear output type	OPn2 = rLY
		A1_d	Alarm 1, Direct Acting		<i>Not linear</i>
		A1_r	Alarm 1, Reverse Acting		<i>Not linear</i>
		A2_d	Alarm 2, Direct Acting		<i>Not linear</i>
		A2_r	Alarm 2, Reverse Acting		<i>Not linear</i>
		Or_d	Logical Alarm 1 OR Alarm 2 Direct Acting		<i>Not linear</i>
		Or_r	Logical Alarm 1 OR Alarm 2 Reverse Acting		<i>Not linear</i>
		Ar_d	Logical Alarm 1 AND Alarm 2, Direct Acting		<i>Not linear</i>
		Ar_r	Logical Alarm 1 AND Alarm 2, Reverse Acting		<i>Not linear</i>
		An_d	Limit Annunciator, Direct Acting		<i>Not linear</i>
		An_r	Limit Annunciator, Reverse Acting		<i>Not linear</i>
		rEtS	Retransmit SP Output		<i>Linear only</i>
		rEtP	Retransmit PV Output		<i>Linear only</i>
Linear Output 2 Range	tYP2	0_5	0 to 5 V DC output 1	0_10	OPn2 = L in
		0_10	0 to 10 V DC output		
		2_10	2 to 10 V DC output		
		0_20	0 to 20 mA DC output		
		4_20	4 to 20 mA DC output		
Retransmit Output 2 Scale maximum	ro2H	- 1999 to 9999 Display value where output is maximum		Range max	USE2 = rEtS or rEtP
Retransmit Output 2 Scale minimum	ro2L	- 1999 to 9999 Display value where output is minimum		Range min	USE2 = rEtS or rEtP
Output 3 Usage	USE3	As for output 2		A1_d	OPn3 is not nonE
Linear Output 3 Range	tYP3	As for output 2		0_10	OPn3 = L in

Parameter	Lower Display	Upper Display	Description	Default Value	When Visible
Retransmit Output 3 Scale maximum	ro3H	- 1999 to 9999	Display value where output is maximum	Range max	USE3 = rEtS or rEtP
Retransmit Output 3 Scale minimum	ro3L	- 1999 to 9999	Display value where output is minimum	Range min	USE3 = rEtS or rEtP
Display Strategy	d,SP	EnAb	PV is visible in Operator mode	EnAb	Always
		d,SA	PV not visible in Operator mode		
Comms Protocol	Prot	ASC I	ASCII	r7bn	OPnA = r485
		r7bn	Modbus with no parity		
		r7bE	Modbus with Even Parity		
		r7bo	Modbus with Odd Parity		
Bit rate	bAud	1.2	1.2 kbps	4.8	OPnA = r485
		2.4	2.4 kbps		
		4.8	4.8 kbps		
		9.6	9.6 kbps		
		19.2	19.2 kbps		
Communications Address	Addr	1	A unique address for each instrument between 1 to 255 (Modbus), or 1 to 99 (Ascii)	1	OPnA = r485
Communications Write Enable	CoEn	r_o	Read only. Comms writes ignored	r_lw	Always
		r_lw	Read / Write. Writing via Comms is possible		
Configuration Mode Lock Code	CLoc	0 to 9999		20	Always

Notes:

Option Slot 1 is a fixed Limit Relay output. A Digital Input module fitted to Option Slot A will duplicate the front Reset key  function.

As these functions cannot be changed, configuration menus are not required.

Alarm parameters marked * are repeated in Setup Mode.

CAUTION:

Process Variable Offset can be used to modify the measured value to compensate for probe errors. Positive values increase the reading, negative values are subtracted. This parameter is effectively, a calibration adjustment and MUST be used with care.

DC120L Limit Controller – Setup Mode

This mode is normally selected only after Configuration Mode has been completed, and is used when a change to the process set up is required.

Note:

Entry into Setup Mode is security-protected by the Setup Mode lock code.

Entry into the Setup Mode

Hold down  and press  to enter the Select Mode



Press  or  to navigate to the Setup Mode option, then press  to enter Setup Mode.

The Setup LED  will light while in Setup mode

Scrolling through Parameters & Values

Press  to scroll through the parameters (refer to the table below) and their values.

Changing Parameter Values

Press  to select the required parameter, then press  or  to set the value as required.

Once the displayed value is changed, the effect is immediate. No confirmation of the change is required.

Note:

If there is no key activity for two minutes, the instrument returns to the operator mode.

Table 17. DC120L Set Up Mode Parameters

Parameter	Lower Display	Upper Display Adjustment Range	Default Value	When Visible
Limit Setpoint value	SP	Scaled Range Minimum to Scaled Range Maximum	Range max when $[trL=H]$, Range min when $[trL=Lo]$	Always
Limit Hysteresis	HYSL	1 LSD to full span in display units, on the safe side of the limit SP	1	Always
Input Filter Time constant	FILT	OFF, 0.5 to 100.0 secs in 0.5 sec increments	2.0	Always
Process High Alarm 1 value*	PHA1	Range Min. to Range Max.	Range Max.	ALA1 = P_H ,
Process Low Alarm 1 value*	PLA1	Range Min. to Range Max.	Range Min.	ALA1 = P_Lo
Deviation Alarm 1 Value*	dAL1	±span from setpoint	5	ALA1 = dE
Band Alarm 1 value*	bAL1	1 LSD to full span from setpoint.	5	ALA1 = bAnd
Alarm 1 Hysteresis*	AHY1	Up to 100% of span	1	Always
Process High Alarm 2 value*	PHA2	Range Min. to Range Max.	Range Max.	ALA2 = P_H ,
Process Low Alarm 2 value*	PLA2	Range Min. to Range Max.	Range Min.	ALA2 = P_Lo
Deviation Alarm 2 Value	dAL2	±span from setpoint	5	ALA2 = dE
Band Alarm 2 value*	bAL2	1 LSD to full span from setpoint.	5	ALA2 = bAnd
Alarm 2 Hysteresis*	AHY2	Up to 100% of span	1	Always
Set-up Lock Code	SLoc	0 to 9999	10	Always

**First Operator mode displays follows.

Note:

Alarm parameters marked * are repeated in Configuration Mode.

Note:

**Once the complete list of Set Up Mode parameters has been displayed, the first Operator Mode display is shown without exiting from Set Up Mode.

CAUTION:

An excessively large filter time could significantly delay detection of a limit condition. Set this value to the minimum required to remove noise from the process variable.

DC120L Limit Controller - Operator Mode

This is the mode used during normal operation of the instrument. It can be accessed from Select Mode, and is the usual mode entered at power-up.

WARNING:

IN NORMAL OPERATION, THE OPERATOR MUST NOT REMOVE THE INSTRUMENT FROM ITS HOUSING OR HAVE UNRESTRICTED ACCESS TO THE REAR TERMINALS, AS THIS WOULD PROVIDE POTENTIAL CONTACT WITH HAZARDOUS LIVE PARTS.

CAUTION:

Set all Configuration Mode parameters and Setup Mode parameters as required before starting normal operations.

Navigating in Operator Mode



Press  to move between displays.

Table 18. DC120L Operator Mode Displays

Upper Display	Lower Display	When Visible	Description
PV Value	Limit SP Value	Display strategy is set to EnAb. (Initial Screen)	Process Variable and Limit Setpoint values. <i>Read only</i>
Limit SP Value	<i>Blank</i>	Display strategy is set to d iSA. (Initial Screen)	Limit Setpoint value only. <i>Read only</i>
High Limit Hold	H iHd	[Ctrl = H] in Configuration Mode	Highest PV value since this parameter was last reset.
Low Limit Hold	LoHd	[Ctrl = Lo] in Configuration Mode	Lowest PV value since this parameter was last reset.
Exceed Time Value	t i	Always available	Accumulated time of Limit SP exceed conditions since this parameter was last reset. Time Format: <i>mm.ss to 99.59, then mmm.s (10 sec increments)</i> Shows [HH] when ≥ 999.9
Active Alarm Status	ALSt	When any alarm is active.  ALM indicator will also flash	1 Alarm 1 Active
			2 Alarm 2 Active
			An Annunciator Active



Limit Setpoint Adjustment

Adjustment of the Limit Setpoint can be only made from Setup Mode.

Exceed Condition

An Exceed Condition occurs when the Process Variable exceeds the Limit Setpoint value (i.e. PV is greater than the Limit Setpoint when set for high limit action, PV is less than the Limit Setpoint for low limit action). The  LED is on during this condition, and is extinguished once it has passed.

Limit Output Function

The Limit Output relay(s) de-energise whenever an Exceed condition occurs, causing the process to shut down. The  LED is on when the relay is de-energised. The relay remains latched off even if the Exceed condition is no longer present. A reset instruction must be given **after the exceed condition has passed** to re-energise the relay, allowing the process to continue. The  LED then turns off.

Limit Annunciator Outputs

An Annunciator output will activate when an Exceed condition occurs, and will remain active until a reset instruction is received, or the Exceed condition has passed. Unlike the Limit Output, an Annunciator can be reset even if the Exceed condition is present. When an Annunciator is active, the  LED will flash and the Alarm Status screen is available.

Resetting Limit Outputs & Annunciators

A reset instruction can be given by any of the following methods. The front panel Reset key, the Digital Input (if fitted) or via Serial Communications command if an RS485 Communications module is fitted.

Using The Reset Key To Reset Limit Outputs & Annunciators

Press the  key reset an active Annunciator or latched Limit Relay.

Note:

Annunciators will deactivate immediately, Limit Outputs will only re-energise if the Exceed condition has passed.

CAUTION:

Ensure that the cause of the Exceed condition has been rectified before resetting the Limit Output.

Resetting Limit Hold and Exceed Time

The highest PV value reached (for High Limit action) or lowest PV value reached (for Low Limit action) and the accumulated time of Limit SP exceed conditions can be viewed.

To reset the stored Limit Hold and Exceed Time values

Display the value to be reset, then press the  key for 5 seconds. The upper display briefly shows ---- when the value is reset.

DC120L Limit Controller – Serial Communications Parameters

The Modbus parameter addresses, and the possible ASCII message types and parameters indents for the DC120L are detailed below. RO indicates a parameter is read only, R/W indicates it can also be written to. Communications writes will not implemented if the Communications Write Parameter is disabled. Refer to the Modbus and ASCII Communications sections of this manual for details of the protocols used.

Bit Parameters

Bit parameters are not applicable to the ASCII protocol.

Table 19. DC120L Communications - Bit Parameters

Parameter	Modbus Parameter No.		Notes
Communication Write Status	1	RO	1 = Write Enabled, 0 = Write Disabled. A negative acknowledgement (exception code 3) is sent to write commands if communications writes are disabled
Limit Action	2	RO	1 = Low Limit, 0 = High Limit
Reset Limit Relay	3	R/W	1 = Reset Latched Relays. A read returns the values 0
Limit Status	4	RO	1 =In Exceed Condition, 0 = Not in Exceed Condition
Alarm 1 Status	5	RO	1 = Active, 0 = Inactive
Alarm 2 Status	6	RO	1 = Active, 0 = Inactive
Limit Output Status	7	RO	1 = Relay latched, 0 = Relay not latched
Annunciator Output Status	8	RO	1 = Active, 0 = Inactive

To set the bit value to 1 write FF, to set the bit value to 0 write 00. Refer to Function Code 05 in the Modbus Communications section.

Word Parameters

Table 20. DC120L Communications - Word Parameters

Parameter	Modbus Parameter No.		ASCII Ident & Message Types		Notes
Process Variable	1	RO	M Type 2	RO	Current value of PV.
					If under-range = 62976 (<??>5 ASCII)
					If over-range = 63232 (<??>0 ASCII)
					If Sensor break = 63488 (ASCII = n/a)
Limit Setpoint	2	R/W	S Type 2, 3/4	R/W	Value of the Limit Setpoint.
Hold Value	3	R/W	A Type 2	RO	Highest PV value (High Limit Action) or Lowest PV value (Low Limit Action) since this parameter was last reset. Modbus: Write any value to reset ASCII: See Controller Command 00160 for reset.

Parameter	Modbus Parameter No.		ASCII Ident & Message Types		Notes
Deviation	4	RO	V Type 2	RO	Difference between Process Variable and Limit Setpoint (value = PV-Limit SP)
Time Exceeded Value	5	R/W	T Type 2	RO	Accumulated time of Limit SP exceed conditions since this parameter was last reset. Modbus: Write any value to reset ASCII: See Controller Command 00170 for reset
Limit Hysteresis	6	R/W	F Type 2, 3/4	R/W	A band on the "safe" side of the Limit SP. Adjustable 0 to 100% of span. A latched limit relay cannot be reset until the process passes through this band
Alarm 1 Value	7	R/W	C Type 2, 3/4	R/W	Alarm 1 active at this level
Alarm 2 Value	8	R/W	E Type 2, 3/4	R/W	Alarm 2 active at this level
Scale Range Lower Limit	9	R/W	H Type 2 Type 3/4	RO R/W	Lower limit of scaled input range
Scale Range Upper Limit	10	R/W	G Type 2 Type 3/4	RO R/W	Upper limit of scaled input range
Decimal Point Position	11	R/W	Q Type 2 Type 3/4	RO R/W	Read only if not Linear Input. 0 = xxxx 1 = xxx.x 2 = xx.xx 3 = x.xxx
Input Filter Time Constant	12	R/W	m Type 2, 3/4	R/W	0 to 100 seconds
Re-transmit output Maximum	13	R/W	[Type 2, 3/4	R/W	Maximum scale value for retransmit output, 1999 to 9999. This parameter applies to the first re-transmit output fitted (see also Modbus parameters 2224, 2225, 2234 & 2235).
Re-transmit Output Minimum	14	R/W	\ Type 2, 3/4	R/W	Minimum scale value for retransmit output, 1999 to 9999. This parameter applies to the first re-transmit output fitted (see also Modbus parameters 2224, 2225, 2234 & 2235).
Process Value Offset	26	R/W	v Type 2 Type 3/4	RO R/W	Modified PV = Actual PV + PV Offset. Limited by Scale Range Max. and Scale Range Min.
Alarm 1 Hysteresis	32	R/W			0 to 100% of span
Alarm 2 Hysteresis	33	R/W			0 to 100% of span

Parameter	Modbus Parameter No.		ASCII Ident & Message Types		Notes																												
Controller Commands			Z Type 3/4	R/W	The Type 3 {DATA} field must be one of three five-digit numbers: 00150 = Reset Limit Outputs 00160 = Reset Hold Value 00170 = Reset Exceed Time value The response contains the same {DATA}. A negative acknowledgement will be returned if Reset in not possible or already implemented.																												
Controller Status			L Type 2	RO	<table border="1"> <thead> <tr> <th>Bits</th> <th>Meaning</th> </tr> </thead> <tbody> <tr> <td>0</td> <td>Alarm 1 status: 0 = Activated, 1 = Safe</td> </tr> <tr> <td>1</td> <td>Alarm 2 status: 0 = Activated, 1 = Safe</td> </tr> <tr> <td>2</td> <td>Not used</td> </tr> <tr> <td>3</td> <td>Change Indicator: 0 = No changes, since Controller Status was last read. 1 = A parameter other than Controller Status or PV has changed</td> </tr> <tr> <td>4</td> <td>Comms write status: 0 = Disabled 1 = Enabled</td> </tr> <tr> <td>5</td> <td>Not used</td> </tr> <tr> <td>6</td> <td>Not used</td> </tr> <tr> <td>7</td> <td>Not used</td> </tr> <tr> <td>8</td> <td>Not used</td> </tr> <tr> <td>9</td> <td>Limit status: 0 = Not Exceeded, 1 = Exceeded</td> </tr> <tr> <td>10</td> <td>Limit Relay Status: 0 = safe, 1 = Latched Off</td> </tr> <tr> <td>11</td> <td>Limit Action: 0 = Low Limit, 1 = High Limit</td> </tr> <tr> <td>12</td> <td>Annunciator status: 0 = inactive, 1 = Active</td> </tr> </tbody> </table>	Bits	Meaning	0	Alarm 1 status: 0 = Activated, 1 = Safe	1	Alarm 2 status: 0 = Activated, 1 = Safe	2	Not used	3	Change Indicator: 0 = No changes, since Controller Status was last read. 1 = A parameter other than Controller Status or PV has changed	4	Comms write status: 0 = Disabled 1 = Enabled	5	Not used	6	Not used	7	Not used	8	Not used	9	Limit status: 0 = Not Exceeded, 1 = Exceeded	10	Limit Relay Status: 0 = safe, 1 = Latched Off	11	Limit Action: 0 = Low Limit, 1 = High Limit	12	Annunciator status: 0 = inactive, 1 = Active
					Bits	Meaning																											
					0	Alarm 1 status: 0 = Activated, 1 = Safe																											
					1	Alarm 2 status: 0 = Activated, 1 = Safe																											
					2	Not used																											
					3	Change Indicator: 0 = No changes, since Controller Status was last read. 1 = A parameter other than Controller Status or PV has changed																											
					4	Comms write status: 0 = Disabled 1 = Enabled																											
					5	Not used																											
					6	Not used																											
					7	Not used																											
					8	Not used																											
					9	Limit status: 0 = Not Exceeded, 1 = Exceeded																											
					10	Limit Relay Status: 0 = safe, 1 = Latched Off																											
11	Limit Action: 0 = Low Limit, 1 = High Limit																																
12	Annunciator status: 0 = inactive, 1 = Active																																
Scan Table] Type 2	RO	Reads back main process values. Response is: L{N}25aaaaabbbbbccccddddeeeeeA* where: aaaaa = Limit Setpoint value bbbbbb = Process Variable value cccc = Hold value dddddd = Exceeded Time value eeeeee = Controller Status (see above)																												
Equipment ID	122	RO			A four digit ident number 1A2Chex																												

Parameter	Modbus		ASCII Ident & Message Types		Notes	
	Parameter No.					
Serial Number Low	123	RO			Digits aaaa	Unit serial number. Format aaaa bbbb cccc, (12 BCD digits).
Serial Number Mid	124	RO			Digits bbbb	
Serial Number High	125	RO			Digits cccc	
Date of manufacture	126	RO			Manufacturing date code as an encoded binary number. E.g. 0403 for April 2003 is returned as 193hex	
Product Revision Level	129	RO			Low Byte	Alpha part of PRL. E.g. A = 01hex
					High Byte	Numeric part of PRL. E.g. 13 = 0Dhex
Firmware Version	130	RO			Bits	Meaning
					0 - 4	Revision number (1,2...)
					5 - 9	Alpha version (A=0, B=1...)
					10 - 15	Numeric version (starting from 121 = 0)
Input status	133	RO			Input status. Read Only. Bit 0: Sensor break flag Bit 1: Under-range flag Bit 2: Over-range flag	
Option Slot 2 Re-transmit output Maximum	2224	R/W			Maximum scale value for retransmit output in slot 2, 1999 to 9999.	
Option Slot 2 Re-transmit output Minimum	2225	R/W			Minimum scale value for retransmit output in slot 2, 1999 to 9999.	
Option Slot 3 Re-transmit output Maximum	2234	R/W			Maximum scale value for retransmit output in slot 3, 1999 to 9999.	
Option Slot 3 Re-transmit output Minimum	2235	R/W			Minimum scale value for retransmit output in slot 3, 1999 to 9999.	

Note:

Some of the parameters that do not apply to a particular configuration will accept reads and writes (e.g. attempting to scale a Linear output which has not been fitted). Read only parameters will return an exception if an attempt is made to write values to them.

10 DI1700 Indicator

The DI1710 1/8 DIN (96 x 48mm) size Indicator is ideal for most process monitoring applications. It is available with a red, green or Red/Green colour change display, with plug-in modules for latching or non-latching relays, transmitter power output, or PV retransmission

- Red, Green or Colour Change display
- Up to five Process Alarms
- PV Retransmit option
- Transmitter PSU option
- Min/max Value hold
- Remote Latched Relay reset
- RS485 Modbus and ASCII comms
- Configuration via PC

DI1700 Indicator - Configuration Mode

This mode is normally used only when the indicator is configured for the first time or when a major change is made to the instruments characteristics. The Configuration Mode parameters must be set as required before adjusting parameters in Setup Mode, or attempting to use the in an application.

Entry into the Configuration Mode

CAUTION:

Adjustments to these parameters should only be performed by personnel competent and authorised to do so.

Configuration is entered from Select Mode

Hold down  and press  to force the controller into the Select Mode.

The **SLCt** legend is shown for 1 second, followed by the legend for the current mode.

Press  or  to navigate to the Configuration Mode option, then press .

Note:

Entry into this mode is security-protected by the Configuration Mode Lock Code. Refer to the Unlock Code section for more details.

Note:

1/8 Din indicators have an additional Set LED . This flashes in Configuration Mode.

Scrolling through Parameters and Values

Press **SETUP** to scroll through the parameters. While this key is pressed, and up to 1 second after, the parameter legend is shown, followed by the current parameter value.

Note:

Only parameters that are applicable to the hardware options chosen will be displayed.

Changing Parameter Values

Press **SETUP** to navigate to the required parameter, then press **▲** or **▼** to set the value as required.

Once the desired value is set, press **SETUP** to display **YES?**, press **▲** within 10 seconds, accept the change, otherwise parameter will revert to previous value.

Or

Press **SETUP** to reject the change and to move onto the next parameter.

Hold down **SETUP** and press **▲** to return to Select Mode.

Note:

If there is no key activity for 2 minutes the instrument returns to the operator mode.

Table 21. DI1700 Configuration Mode Parameters

Parameter	Legend <i>for 1 sec followed by</i> 	Set Value	Adjustment Range & Description	Default Value	When Visible	DI1700 Units Display
Input type and Range	InPt	bC	B type: 100 to 1824 °C	JC	Always	r
		bF	B type: 211 to 3315 °F			
		C	C type: 0 to 2320 °C			
		CF	C type: 32 to 4208 °F			
		JC	J type: -200 to 1200 °C			
		JF	J type: -328 to 2192 °F			
		J.C	J type: -128.8 to 537.7 °C with decimal point			
		J.F	J type: -199.9 to 999.9 °F with decimal point			
		KC	K type: -240 to 1373 °C			
		KF	K type: -400 to 2503 °F			
		K.C	K type: -128.8 to 537.7 °C with decimal point			
		K.F	K type: -199.9 to 999.9 °F with decimal point			

Parameter	Legend <i>for 1 sec followed by</i> →	Set Value	Adjustment Range & Description	Default Value	When Visible	DI1700 Units Display
		LC	L type: 0 to 762 °C			
		LF	L type: 32 to 1403 °F			
		L.C	L type: 0.0 to 537.7 °C with decimal point			
		L.F	L type: 32.0 to 999.9 °F with decimal point			
		NC	N type: 0 to 1399 °C			
		NF	N type: 32 to 2551 °F			
		rC	R type: 0 to 1759 °C			
		rF	R type: 32 to 3198 °F			
		SC	S type: 0 to 1762 °C			
		SF	S type: 32 to 3204 °F			
		tC	T type: -240 to 400 °C			
			T type: -400 to 752 °F			
		t.C	T type: -128.8 to 400.0 °C with decimal point			
		t.F	T type: -199.9 to 752.0 °F with decimal point			
		P24C	PtRh20% vs PtRh40%: 0 to 1850 °C			
		P24F	PtRh20% vs PtRh40%: 32 to 3362 °F			
		PtC	Pt100: -199 to 800 °C			
			Pt100: -328 to 1472 °F			
		Pt.C	Pt100: -128.8 to 537.7 °C with decimal point			
		Pt.F	Pt100: -199.9 to 999.9 °F with decimal point			
		0_20	0 to 20mA DC			
		4_20	4 to 20mA DC			
		0_50	0 to 50mV DC			
		10_50	10 to 50mV DC			
		0_5	0 to 5V DC			
		1_5	1 to 5V DC			
		0_10	0 to 10V DC			
			2 to 10V DC			

Parameter	Legend <i>for 1 sec followed by</i> by 	Set Value	Adjustment Range & Description	Default Value	When Visible	DI1700 Units Display
Scale Range Upper Limit	rUL		Scale Range Lower Limit +100 to Range Max	Linear = 1000 °C/°F = max range	Always	u
Scale Range Lower Limit	rLL		Range Min. to Scale range Upper Limit - 100	Linear = 0 °C/°F = min range	Always	L
Decimal point position	dPoS	0	Decimal point position in non-temperature ranges. 0 = XXXX 1 = XXX.X 2 = XX.XX 3 = X.XXX	1	InPt = mV, V or mA	P
		1				
		2				
		3				
Linear Range Engineering Units Display	L inU	nonE	nonE (Blank), C = °C or F = °F For use where linear inputs represent temperature. <i>Available on 1/8 Din units only.</i>	nonE	1/8 Din only. InPt = mV, V or mA	C
		C				F
		F				F
Multi-Point Scaling	MP5	EnAb	dISA disabled or EnAb enabled	dISA	Always	S
		dISA				
Alarm 1 Type	ALA1	P_H1	Process High Alarm	P_H1	Always	1
		P_Lo	Process Low Alarm			
		nonE	No alarm			
Process High Alarm 1 value*	PHA1		Range Min. to Range Max. <i>Parameter repeated in Setup Mode</i>	Range Max.	ALA1 = P_H1	A if alarm 1 only or 1
Process Low Alarm 1 value*	PLA1		Range Min. to Range Max. <i>Parameter repeated in Setup Mode</i>	Range Min.	ALA1 = P_Lo	1
Alarm 1 Hysteresis*	AHY1		1 LSD to 100% of span (in display units) on "safe" side of alarm point. <i>Parameter repeated in Setup Mode</i>	1	ALA1 is not nonE	-
Alarm 2 Type	ALA2		As for alarm 1 type	nonE	Always	2
Process High Alarm 2 value*	PHA2		Range Min. to Range Max. <i>Parameter repeated in Setup Mode</i>	Range Max.	ALA2 = P_H1	2
Process Low Alarm 2 value*			Range Min. to Range Max. <i>Parameter repeated in Setup Mode</i>	Range Min.	ALA2 = P_Lo	
Alarm 2 Hysteresis*	AHY2		1 LSD to 100% of span (in display units) on "safe" side of alarm point. <i>Parameter repeated in Setup Mode</i>	1	ALA2 is not nonE	=

Parameter	Legend <i>for 1 sec followed by</i> →	Set Value	Adjustment Range & Description	Default Value	When Visible	DI1700 Units Display
Alarm 3 Type	ALA3	As for alarm 1 type		nonE	Always	3
Process High Alarm 3 value*		Range Min. to Range Max. <i>Parameter repeated in Setup Mode</i>		Range Max.	ALA3 = P_H	3
Process Low Alarm 3 value*	PLA3	Range Min. to Range Max. <i>Parameter repeated in Setup Mode</i>		Range Min.	ALA3 = P_Lo	
Alarm 3 Hysteresis*	AHY3	1 LSD to 100% of span (in display units) on "safe" side of alarm point. <i>Parameter repeated in Setup Mode</i>		1	ALA3 is not nonE	3
Alarm 4 Type	ALA4	As for alarm 1 type		nonE	Always	4
Process High Alarm 4 value*	PHA4	Range Min. to Range Max. <i>Parameter repeated in Setup Mode</i>		Range Max.	ALA4 = P_H	4
Process Low Alarm 4 value*	PLA4	Range Min. to Range Max. <i>Parameter repeated in Setup Mode</i>		Range Min.	ALA4 = P_Lo	
Alarm 4 Hysteresis*	AHY4	1 LSD to 100% of span (in display units) on "safe" side of alarm point. <i>Parameter repeated in Setup Mode</i>		1	ALA4 is not nonE	4
Alarm 5 Type	ALA5	As for alarm 1 type		nonE	Always	5
Process High Alarm 5 value*	PHA5	Range Min. to Range Max. <i>Parameter repeated in Setup Mode</i>		Range Max.	ALA5 = P_H	5
Process Low Alarm 5 value*	PLA5	Range Min. to Range Max. <i>Parameter repeated in Setup Mode</i>		Range Min.	ALA5 = P_Lo	
Alarm 5 Hysteresis*	AHY5	1 LSD to 100% of span (in display units) on "safe" side of alarm point. <i>Parameter repeated in Setup Mode</i>		1	ALA5 is not nonE	5
Output 1 Usage	USE 1	A 1nd	Alarm 1, direct, non-latching	A 1nd when OPn 1 is not linear output type, rEtP if OPn 1 is linear output type	OPn 1 is not empty	1
		A 1nr	Alarm 1, reverse, non-latching			
		A 1Ld	Alarm 1, direct, latching			
		A 1Lr	Alarm 1, reverse, latching			
		A 2nd	Alarm 2, direct, non-latching			
		A 2nr	Alarm 2, reverse, non-latching			
		A 2Ld	Alarm 2, direct, latching			
		A 2Lr	Alarm 2, reverse, latching			
		A 3nd	Alarm 3, direct, non-latching			
		A 3nr	Alarm 3, reverse, non-latching			
		A 3Ld	Alarm 3, direct, latching			
		A 3Lr	Alarm 3, reverse, latching			

Parameter	Legend <i>for 1 sec followed by</i> →	Set Value	Adjustment Range & Description	Default Value	When Visible	DI1700 Units Display
		<i>A4nd</i>	Alarm 4, direct, non-latching			
		<i>A4nr</i>	Alarm 4, reverse, non-latching			
		<i>A4Ld</i>	Alarm 4, direct, latching			
		<i>A4Lr</i>	Alarm 4, reverse, latching			
		<i>A5nd</i>	Alarm 5, direct, non-latching			
			Alarm 5, reverse, non-latching			
		<i>A5Ld</i>	Alarm 5, direct, latching			
		<i>A5Lr</i>	Alarm 5, reverse, latching			
		<i>0 12d</i>	Logical Alarm 1 OR 2, direct			
		<i>0 12r</i>	Logical Alarm 1 OR 2, reverse			
		<i>0 13d</i>	Logical Alarm 1 OR 3, direct			
		<i>0 13r</i>	Logical Alarm 1 OR 3, reverse			
		<i>0 23d</i>	Logical Alarm 2 OR 3, direct			
		<i>0 23r</i>	Logical Alarm 2 OR 3, reverse			
		<i>Aanyd</i>	Any active alarm, direct			
		<i>Aanyr</i>	Any active alarm, reverse			
			Retransmit PV Output		<i>OPn I</i> is linear output type	
		<i>dc 10</i>	0 to 10VDC (adjustable) transmitter power supply*			
Output 1 PV Retransmit Type	<i>tYP 1</i>		0 to 5 V DC output 1	<i>0_10</i>	<i>USE 1 = rEtP</i>	<i>I</i>
		<i>0_10</i>	0 to 10 V DC output			
		<i>2_10</i>	2 to 10 V DC output			
		<i>0_20</i>	0 to 20 mA DC output			
		<i>4_20</i>	4 to 20 mA DC output			
Retransmit Output 1 Scale maximum	<i>ro IH</i>	- 1999 to 9999 Display value where output is maximum	Range max	<i>USE 1 = rEtP</i>	<i>H</i>	
Retransmit Output 1 Scale minimum	<i>ro IL</i>	- 1999 to 9999 Display value where output is minimum	Range min	<i>USE 1 = rEtP</i>	<i>L</i>	
Output 1 TxPSU voltage level	<i>PSU 1</i>	0 to 10VDC transmitter power supply output in 0.1V steps*		<i>10.0</i>	<i>USE 1 = dc 10</i>	<i>I</i>

Parameter	Legend <i>for 1 sec followed by</i> →	Set Value	Adjustment Range & Description	Default Value	When Visible	DI1700 Units Display
Output 2 Usage	USE2	As for Output 1 usage		A2nd or rEtP	OPn2 is not empty	2
Output 2 PV Retransmit Type	tYP2	0_5	0 to 5 V DC output 1	0_10	USE2 = rEtP	2
		0_10	0 to 10 V DC output			
		2_10	2 to 10 V DC output			
		0_20	0 to 20 mA DC output			
		4_20	4 to 20 mA DC output			
Retransmit Output 2 Scale maximum	ro2H	- 1999 to 9999 Display value where output is maximum		Range max	USE2 = rEtP	H
Retransmit Output 2 Scale minimum	ro2L	- 1999 to 9999 Display value where output is minimum		Range min	USE2 = rEtP	L
Output 2 TxPSU voltage level	PSU2	0 to 10VDC transmitter power supply output in 0.1V steps*		10.0	USE2 = dc 10	2
Output 3 Usage	USE3	As for Output 1 usage		A3nd or rEtP	OPn3 is not empty	3
Output 3 PV Retransmit Type	tYP3	0_5	0 to 5 V DC output 1	0_10	USE3 = rEtP	3
		0_10	0 to 10 V DC output			
		2_10	2 to 10 V DC output			
		0_20	0 to 20 mA DC output			
		4_20	4 to 20 mA DC output			
Retransmit Output 3 Scale maximum	ro3H	- 1999 to 9999 Display value where output is maximum		Range max	USE3 = rEtP	H
Retransmit Output 3 Scale minimum	ro3L	- 1999 to 9999 Display value where output is minimum		Range min	USE3 = rEtP	L
Output 3 TxPSU voltage level	PSU3	0 to 10VDC transmitter power supply output in 0.1V steps*		10.0	USE3 = dc 10	3
Output 4 Usage	USE4	Alarm output options as for Output 1 usage (<i>Linear retransmit and PSU not possible</i>)		A4nd	OPn4 = drLY	4
Output 5 Usage	USE5	Alarm output options as for Output 1 usage (<i>Linear retransmit and PSU not possible</i>)		A5nd	OPn5 = drLY	5

Parameter	Legend <i>for 1 sec followed by</i> by →	Set Value	Adjustment Range & Description	Default Value	When Visible	DI1700 Units Display
Display Strategy	d,SP	0, 1, 2, 3, 4 or 6 <i>(see Operator Mode for details)</i>		0	Always	d
Display Colour	CLor	rEd	Permanent Red	G-r	1/8 Din units if colour change display fitted	c
		Grn	Permanent Green			
		r-G	Red to Green if any alarm active			
		G-r	Green to Red if any alarm active			
Comms Protocol	Prot	ASC I	ASCII	r7bn	OPnA = r485	P
		r7bn	Modbus with no parity			
		r7bE	Modbus with Even Parity			
		r7bo	Modbus with Odd Parity			
Bit rate	bAud	1.2	1.2 kbps	4.8	OPnA = r485	b
		2.4	2.4 kbps			
		4.8	4.8 kbps			
		9.6	9.6 kbps			
		19.2	19.2 kbps			
Communications Address	Addr	1	A unique address for each instrument between 1 to 255 (Modbus), or 1 to 99 (Ascii)	1	OPnA = r485	A
Communications Write Enable	CoEn	r_o	Read only. Comms writes ignored	r_LU	Always	E
		r_LU	Read / Write. Writing via Comms is possible			
Digital Input Usage	d i ,	rrLY	Reset latched relay(s)	rrLY	OPnA = d i ,	,
		tArE	Initiate Tare (zero display)			
		rPU	Reset min/max PV values			
		rE	Reset Alarm 1 elapsed time			
		rPUE	Reset Alarm 1 elapsed time & min/max PV values			
Configuration Mode Lock Code	CLoc	0 to 9999		20	Always	C

Note:

*Linear Outputs can be configured to provide an adjustable 0.0 to 10.0VDC transmitter power supply for external devices. This is an alternative to the fixed 24V Transmitter Power Supply option module.

DI1700 Indicator - Setup Mode

This mode is normally selected only after Configuration Mode has been completed, or is used when a change to the process set up is required. These parameters must be set as required before attempting to use the indicator in an application.

Entry into the Setup Mode

Setup Mode is entered from Select Mode

Hold down  and press  to force the controller into the Select Mode.

The **SLCt** legend is shown for 1 second, followed by the legend for the current mode.

Press  or  to navigate to the Setup Mode option, then press .

Note:

Entry into Setup Mode is security-protected by the Setup Mode lock code. Refer to the Unlock Code section for more details.



Note:

1/8 Din indicators have an additional Set LED . This is on in Setup Mode.

Scrolling through Parameters and Values

Press  to scroll through the parameters. While this key is pressed, and up to 1 second after, the parameter legend is shown, followed by the current parameter value.

Changing Parameter Values

Press  to select the required parameter, then press  or  to set the value as required.

Once the displayed value is changed, it is effective immediately. No confirmation of the change is required.

Press  to move onto the next parameter.

Hold down  and press  to return to Select Mode.

Note:

If there is no key activity for two minutes the instrument returns to the operator mode.

Table 22. DI1700 Set Up Mode Parameters

Parameter	Legend <i>for 1 sec followed by</i> 	Set Value	Adjustment Range & Description	Default Value	When Visible	DI1700 Units Display
Input Filter Time constant	F ILT	OFF, 0.5 to 100.0 seconds in 0.5 sec increments		2.0	Always	t
Process Variable Offset	OFFS	±Instrument Span		0	Always	o
Raw Process Variable value	SG	The un-scaled value of the input signal in mV, V or mA DC as defined by the input range and type. Resolution to 1 decimal place (e.g. 4.0 to 20.0mA). <i>This parameter is Read Only</i>			InPt = mV, V or mA	blank
Process High Alarm 1 value*	PHA1	Range Min. to Range Max. <i>Repeat of Configuration Mode parameter</i>		Range Max.	ALA1 = P_H ,	A if alarm 1 only or !
Process Low Alarm 1 value*	PLA1	Range Min. to Range Max. <i>Repeat of Configuration Mode parameter</i>		Range Min.	ALA1 = P_Lo	
Alarm 1 Hysteresis*	AHY1	1 LSD to 100% of span (in display units) on “safe” side of alarm point. <i>Repeat of Configuration Mode parameter</i>		1	ALA1 is not nonE	-
Process High Alarm 2 value*	PHA2	Range Min. to Range Max. <i>Repeat of Configuration Mode parameter</i>		Range Max.	ALA2 = P_H ,	2
Process Low Alarm 2 value*	PLA2	Range Min. to Range Max. <i>Repeat of Configuration Mode parameter</i>		Range Min.	ALA2 = P_Lo	
Alarm 2 Hysteresis*	AHY2	1 LSD to 100% of span (in display units) on “safe” side of alarm point. <i>Repeat of Configuration Mode parameter</i>		1	ALA2 is not nonE	=
Process High Alarm 3 value*	PHA3	Range Min. to Range Max. <i>Repeat of Configuration Mode parameter</i>		Range Max.	ALA3 = P_H ,	3
Process Low Alarm 3 value*	PLA3	Range Min. to Range Max. <i>Repeat of Configuration Mode parameter</i>		Range Min.	ALA3 = P_Lo	
Alarm 3 Hysteresis*	AHY3	1 LSD to 100% of span (in display units) on “safe” side of alarm point. <i>Repeat of Configuration Mode parameter</i>		1	ALA3 is not nonE	=
Process High Alarm 4 value*	PHA4	Range Min. to Range Max. <i>Repeat of Configuration Mode parameter</i>		Range Max.	ALA4 = P_H ,	4
Process Low Alarm 4 value*	PLA4	Range Min. to Range Max. <i>Repeat of Configuration Mode parameter</i>		Range Min.	ALA4 = P_Lo	
Alarm 4 Hysteresis*	AHY4	1 LSD to 100% of span (in display units) on “safe” side of alarm point. <i>Repeat of Configuration Mode parameter</i>		1	ALA4 is not nonE	4

Parameter	Legend <i>for 1 sec followed by</i> →	Set Value	Adjustment Range & Description	Default Value	When Visible	DI1700 Units Display
Process High Alarm 5 value*	PHAS		Range Min. to Range Max. <i>Repeat of Configuration Mode parameter</i>	Range Max.	ALAS = P_H	5
Process Low Alarm 5 value*	PLAS		Range Min. to Range Max. <i>Repeat of Configuration Mode parameter</i>	Range Min.	ALAS = P_Lo	
Alarm 5 Hysteresis*	AHYS		1 LSD to 100% of span (in display units) on "safe" side of alarm point. <i>Repeat of Configuration Mode parameter</i>	1	ALAS is not nonE	5
Scaling Breakpoint 1	ScA1		Multi-point scaling breakpoint 1 value, adjustable from 0 to 100 in % of span	100	PPPS = EnAb	1
Display Value 1	d,51		Value to be displayed at multi-point scaling breakpoint 1, in display units	Range Max.		
Scaling Breakpoint 2	ScA2		Multi-point scaling breakpoint 2, adjustable up to 100% of span. Must be > ScA1 value		PPPS = EnAb	2
Display Value 2	d,52		Value to be displayed at Multi-point scaling breakpoint 2, in display units			
Scaling Breakpoint 3	ScA3		Multi-point scaling breakpoint 3, adjustable up to 100% of span. Must be > ScA2 value		PPPS = EnAb	3
Display Value 3	d,53		Value to be displayed at Multi-point scaling breakpoint 3, in display units			
Scaling Breakpoint 4	ScA4		Multi-point scaling breakpoint 4, adjustable up to 100% of span. Must be > ScA3 value		PPPS = EnAb	4
Display Value 4	d,54		Value to be displayed at Multi-point scaling breakpoint 4, in display units			
Scaling Breakpoint 5	ScA5		Multi-point scaling breakpoint 5, adjustable up to 100% of span. Must be > ScA4 value		PPPS = EnAb	5
Display Value 5	d,55		Value to be displayed at Multi-point scaling breakpoint 5, in display units			
Scaling Breakpoint 6	ScA6		Multi-point scaling breakpoint 6, adjustable up to 100% of span. Must be > ScA5 value		PPPS = EnAb	6
Display Value 6	d,56		Value to be displayed at Multi-point scaling breakpoint 6, in display units			
Scaling Breakpoint 7	ScA7		Multi-point scaling breakpoint 7, adjustable up to 100% of span. Must be > ScA6 value		PPPS = EnAb	7
Display Value 7	d,57		Value to be displayed at Multi-point scaling breakpoint 7, in display units			
Scaling Breakpoint 8	ScA8		Multi-point scaling breakpoint 8, adjustable up to 100% of span. Must be > ScA7 value		PPPS = EnAb	8
Display Value 8	d,58		Value to be displayed at Multi-point scaling breakpoint 8, in display units			

Parameter	Legend <i>for 1 sec followed by</i> →	Set Value	Adjustment Range & Description	Default Value	When Visible	DI1700 Units Display
Scaling Breakpoint 9	ScA9		Multi-point scaling breakpoint 9, adjustable up to 100% of span. Must be > ScAB value		SP5 = EnAb	9
Display Value 9	d,59		Value to be displayed at Multi-point scaling breakpoint 9, in display units			
Tare Function	tArE	EnAb	Enables or disables the input auto-zero Tare feature	d,5A	Always	r
		d,5A				
Set-up Lock Code	SLoc	0 to 9999		10	Always	5

**Operator mode displays follows.

Note:

*Alarm parameters marked * are repeated in Configuration Mode.*

Note:

***Once the complete list of Set Up Mode parameters has been displayed, the Operator Mode displays are shown without exiting from Set Up Mode.*

DI1700 Indicator - Operator Mode

This is the mode used during normal operation of the instrument. It can be accessed from Select Mode, and is the usual mode entered at power-up. The available displays are dependent upon the setting of the Display Strategy parameter in Configuration Mode.

WARNING:

IN NORMAL OPERATION, THE OPERATOR MUST NOT REMOVE THE INSTRUMENT FROM ITS HOUSING OR HAVE UNRESTRICTED ACCESS TO THE REAR TERMINALS, AS THIS WOULD PROVIDE POTENTIAL CONTACT WITH HAZARDOUS LIVE PARTS.

CAUTION:

Set all Configuration Mode parameters and Set Up Mode parameters as required before starting normal operations.

Entry into Operator Mode

This is the normal operating mode of the instrument from power-up. It can also be accessed from any other mode via Select Mode as follows:

Hold down  and press  to force the controller into the Select Mode.



The **SLCT** legend is shown for 1 second, followed by the legend for the current mode.

Press  or  to navigate to the Operator Mode option, then press .

Scrolling through Parameters and Values

Press  to scroll through the parameters. While this key is pressed, and up to 1 second after, the parameter legend is shown, followed by the current parameter value.

Changing Parameter Values

Press  to select the required parameter, then press  or  to set the value as required.





Once the displayed value is changed, it is effective immediately. No confirmation of the change is required.

Press  to move onto the next parameter.

Note:

The operator can freely view the parameters in this mode, but alteration depends on the Display strategy setting in Configuration Mode. All parameters in Display strategy 6 are read only, and can only be adjusted via Setup mode.

Table 23. DI1700 Operator Mode Displays

Parameter	Legend <i>for 1 sec followed by</i> 	Set Value	Adjustment Range & Description	Display Strategy & When Visible	DI1700 Units Display
Process Variable	Proc		Current Process Variable value <i>Read only, but latched relays can be reset (*see below)</i>	Always	C, F or blank
Maximum PV Value	MA		Maximum displayed value (inc CHH) or OPEN) since MA was last reset. Max LED  is lit	Strategies 0, 1, 3, 4, & 6	C, F or blank
Minimum PV Value	MI		Minimum displayed value (inc LLL) or OPEN) since MI was last reset. Min LED  is lit	Strategies 0, 1, 3, 4, & 6	C, F or blank
Alarm 1 Active Time	Et		Accumulated time alarm 1 has been active since Et was last reset. Format <i>mm.ss to 99.59 then mmm.s (10 sec increments)</i> <i>Shows CHH if >999.9</i>	Strategies 0, 4 & 6 if alarm 1 configured.	E
Process Alarm 1 value			Alarm 1 value. <i>Adjustable except in Strategy 6</i>	Strategies 2, 3, 4 & 6 if alarm 1 configured	A if alarm 1 only or 1
Process Alarm 2 value	AL2		Alarm 2 value. <i>Adjustable except in Strategy 6</i>	Strategies 2, 3, 4 & 6 if alarm 2 configured	2
Process Alarm 3 value*	AL3		Alarm 3 value. <i>Adjustable except in Strategy 6</i>	Strategies 2, 3, 4 & 6 if alarm 3 configured	3
Process Alarm 4 value	AL4		Alarm 4 value. <i>Adjustable except in Strategy 6</i>	Strategies 2, 3, 4 & 6 if alarm 4 configured	4
Process Alarm 5 value*	AL5		Alarm 5 value. <i>Adjustable except in Strategy 6</i>	Strategies 2, 3, 4 & 6 if alarm 5 configured	5
Active Alarm Status	ALSt	The alarm status screen indicates any active alarms.  In addition, the associated Alarm LED flashes. <i>*Latched relays can be reset (see below)</i>	Display(s) show active alarms. Inactive alarms are blank		
				Alarm 1 Active	1
			2	Alarm 2 Active	
			3	Alarm 3 Active	
			4	Alarm 4 Active	
			5	Alarm 5 Active	

DI17100 Indicator Units Display

The DI1700 indicator has an additional Units Display. In Operator Mode, this display shows °C or °F when a temperature input range is displayed, and is blank for linear inputs. The units display is also used in other modes as a confirmation of the parameter type currently shown in the main display.

Alarm Indications



The alarm status screen indicates any active alarms, in addition, their associated Alarm LED flashes.

For latching alarm outputs, the LED **FLASHES** when the alarm condition exists, and goes to **ON** when the alarm condition is no longer present if the output has not yet been reset, to indicate that the relay is in the Latched on condition.

*Resetting Latched Alarm Outputs

Latched outputs can be reset whilst the Process variable or Alarm Status screens are displayed, via the Digital Input (if fitted), with a communications command via the RS485 module (if fitted) or from the front keypad as follows:

Press either  or  to reset the latched relay(s).

Note:

Outputs will only reset if their alarm condition is no longer present.

CAUTION:

A reset will affect ALL latched outputs.

Resetting Alarm 1 Active Time, Minimum PV or Maximum PV

The stored Maximum PV value, Minimum PV value or Alarm 1 active Elapsed Time value can be reset via the Digital Input (if fitted), with a communications command via the RS485 module (if fitted) or from the front keypad as follows:

Press  to select the parameter to be reset.

Press either  or  for three seconds.

The display briefly shows ---- when the value is reset before the unit reverts to the requested display.

Multi-Point Scaling

When Multi-Point Scaling is enabled ($MPS = ENAB$ in Configuration Mode), up to 9 breakpoints can be set to linearize the input signal. This only applies to mA, mV or Voltage input types.

For each breakpoint the input scale value ($ScAn$) is entered in % of input span, followed by the value to be shown (dSn) in display units. Each breakpoint's input scale value must be higher than the previous value, but the display values can be either higher or lower. Any scale value set to 100% becomes the last in the series.

Tare Feature

When Tare is enabled ($TARE = ENAB$ in Configuration Mode), it can be used to set the displayed value to zero automatically, by making the PV Offset parameter equal, but opposite to, the current process variable value.

Tare can be initiated via the Digital Input (if fitted), with a communications command via the RS485 module (if fitted) or by using the following key press sequence:

Press  until the process variable is displayed.

Hold down  and  together for three seconds until the display shows **YES?**

Release both keys and press  within 3 seconds to confirm the request.

Note:

The Tare request is aborted if this sequence is not followed exactly.

DI1700 Indicator – Serial Communications Parameters

The Modbus parameter addresses, and the possible ASCII message types and parameters indents for the DI1700 are detailed below. RO indicates a parameter is read only, WO indicates a parameter is write only and R/W indicates it can read from or written to. Communications writes will not implemented if the Communications Write Parameter is disabled. Refer to the Modbus and ASCII Communications sections of this manual for details of the protocols used.

Bit Parameters

Bit parameters are not applicable to the ASCII protocol.

Table 24. DI1700 Communications - Bit Parameters

Parameter	Modbus Parameter No.		Notes
Alarm 1 Status	1	RO	1 = Active, 0 = Inactive
Alarm 2 Status	2	RO	1 = Active, 0 = Inactive
Alarm 3 Status	3	RO	1 = Active, 0 = Inactive
Alarm 1 Latched	4		1 = Alarm 1 Latched, 0 = Not Latched*
PV Under Range	5	RO	1 = PV Under-range, 0 = PV within range
PV Over Range		RO	1 = PV Over-range, 0 = PV within range
Sensor Break		RO	1 = Sensor Break Active, 0 = Sensor Break Inactive
Latched Alarm Reset	8	WO	Writing any value resets all latched alarm relays. Note: Outputs will only reset if their alarm condition is no longer present.
Reset Maximum PV	9	WO	Writing any value resets the stored maximum displayed PV value
Reset Minimum PV	10	WO	Writing any value resets the stored minimum displayed PV value
Reset Elapsed Time	11		Writing any value resets the stored alarm 1 active time value
Alarm 5 Status	12	RO	1 = Active, 0 = Inactive
Alarm 5 Status	13	RO	1 = Active, 0 = Inactive
Alarm 2 Latched	14	RO	1 = Alarm 2 Latched, 0 = Not Latched*
Alarm 3 Latched	15		1 = Alarm 3 Latched, 0 = Not Latched*
Alarm 4 Latched	16	RO	1 = Alarm 4 Latched, 0 = Not Latched*
Alarm 5 Latched		RO	1 = Alarm 5 Latched, 0 = Not Latched*

To set the bit value to 1 write FF, to set the bit value to 0 write 00. Refer to Function Code 05 in the Modbus Communications section

***Note:**

Alarm Latched status requests always returns 0 if that alarm is not configured to be latching.

Word Parameters

Table 25. DI1700 Communications - Word Parameters

Parameter	Modbus Parameter No.		ASCII Ident & Message Types		Notes	
Process Variable	1	RO	Type 2	RO	Current value of PV.	
					If under-range = 62976 (<??>5 ASCII)	
					If over-range = 63232 (<??>0 ASCII)	
					Sensor break = 63488 (ASCII = n/a)	
Process Variable Maximum	2	RO	Type 2	RO	Maximum displayed value since this was last reset. Shows under/over-range or break values if appropriate.	
Process Variable Minimum	3	RO	B Type 2	RO	Minimum displayed value since this was last reset. Shows under/over-range or break values if appropriate.	
Alarm 1 Elapsed Time	4	RO	T Type 2	RO	Accumulated alarm 1 active time since this was last reset. Returns the over-range value if the time exceeds 1000 minutes. Units = seconds in Modbus	
Instrument Status	5		L Type 2	RO	Bit	
					Meaning	
					0	Alarm 1 status. 0 = activated, 1 = safe
					1	Alarm 2 status. 0 = activated, 1 = safe
					2	Alarm 3 status. 0 = activated, 1 = safe
					3	Change Indicator. 1 = A parameter other than instrument status or PV has changed since the last time the status word was read.
					4	This bit always = 1
					5	Alarm 1 latched status. 0 = latched 1 = not latched or non-latching output type
6	This bit always = 0					
7	This bit always = 0					
Process Variable Offset		R/W	J Type 2, 3/4	R/W	Modified PV = Actual PV + PV Offset. Limited by Scale Range Maximum and Scale Range Minimum.	
Alarm 1 Value	7	R/W	C Type 2, 3/4	R/W	Alarm 1 active at this level	
Alarm 2 Value		R/W	E Type 2, 3/4	R/W	Alarm 2 active at this level	
Alarm 3 Value	9	R/W	Type 2, 3/4	R/W	Alarm 3 active at this level	

Parameter	Modbus Parameter No.		ASCII Ident & Message Types		Notes
Alarm 1 Hysteresis	10	R/W	D Type 2, 3/4	R/W	0 to 100% of span
Alarm 2 Hysteresis	11	R/W	F Type 2, 3/4	R/W	0 to 100% of span
Alarm 3 Hysteresis	12	R/W	O Type 2, 3/4	R/W	0 to 100% of span
Input Filter Time Constant	13	R/W	m Type 2, 3/4	R/W	0 to 100 seconds
Decimal Point Position	14	R/W	Q Type 2 Type 3/4	RO R/W	0 = xxxx 1 = xxx.x 2 = xx.xx 3 = x.xxx Read only if not Linear Input.
Scale Range Lower Limit	15	R/W	H Type 2 Type 3/4	RO R/W	Lower limit of scaled input range
Scale Range Upper Limit		R/W	G Type 2 Type 3/4	RO R/W	Upper limit of scaled input range
Re-transmit Output Maximum	18	R/W	[Type 2, 3/4	R/W	Maximum scale value for retransmit output, 1999 to 9999. This parameter applies to the first re-transmit output fitted (see also Modbus parameters 2214, 2224 & 2234).
Re-transmit Output Minimum	17	R/W	\ Type 2, 3/4	R/W	Minimum scale value for retransmit output, 1999 to 9999. This parameter applies to the first re-transmit output fitted (see also Modbus parameters 2215, 2225 & 2235).
Scan Table			Type 2	R	Reads back main process values. Response is: L{N}25aaaaabbbbb ccccddeeeeA* where: aaaaa = Process Variable value bbbbbb = Stored Maximum PV value cccc = Stored Minimum PV value dddd = Stored Alarm 1 Elapsed Time eeee = Instrument Status (see above)
Instrument commands			Z Type 3/4	WO	Only Type 3 / 4 ASCII messages are allowed with this parameter. The {DATA} field must be one of four 5-digit numbers. The commands corresponding to the {DATA} field value are: 00150 = Unlatch Alarm 1 relay 00160 = Reset Stored Max PV 00170 = Reset Stored Min PV 00180 = Reset Alm1 Elapsed Time
Equipment ID	122				A four digit ident number 1F4Ahex

Parameter	Modbus		ASCII Ident & Message Types		Notes	
	Parameter No.					
Serial Number Low	123	RO			Digits aaaa	Unit serial number. Format aaaa bbbb cccc, (12 BCD digits).
Serial Number Mid	124	RO			Digits bbbb	
Serial Number High	125	RO			Digits cccc	
Date of manufacture	126	RO			Manufacturing date code as an encoded binary number. E.g. 0403 for April 2003 is returned as 193hex	
Product Revision Level	129	RO			Low Byte	Alpha part of PRL. E.g. A = 01hex
					High Byte	Numeric part of PRL. E.g. 13 = 0Dhex
Firmware Version	130	RO			Bits	Meaning
					0 - 4	Revision number (1,2...)
					5 - 9	Alpha version (A=0, B=1...)
					10 - 15	Numeric version (starting from 121 = 0)
Input status	133	RO			Input status. Read Only. Bit 0: Sensor break flag Bit 1: Under-range flag Bit 2: Over-range flag	
Tare Enable	2111	R/W			0 = Disabled, 1 = Enabled	
Tare Activate	2112	RO			Write any value to activate.	
Option Slot 1 Re-transmit output Maximum	2214	R/W			Maximum scale value for retransmit output in slot 1, 1999 to 9999.	
Option Slot 1 Re-transmit output Minimum	2215	R/W			Minimum scale value for retransmit output in slot 1, 1999 to 9999.	
Option Slot 2 Re-transmit output Maximum	2224	R/W			Maximum scale value for retransmit output in slot 2, 1999 to 9999.	
Option Slot 2 Re-transmit output Minimum	2225	R/W			Minimum scale value for retransmit output in slot 2, 1999 to 9999.	
Option Slot 3 Re-transmit output Maximum	2234	R/W			Maximum scale value for retransmit output in slot 3, 1999 to 9999.	
Option Slot 3 Re-transmit output Minimum	2235	R/W			Minimum scale value for retransmit output in slot 3, 1999 to 9999.	

Note:

Some of the parameters that do not apply to a particular configuration will accept reads and writes (e.g. attempting to scale a Linear output which has not been fitted). Read only parameters will return an exception if an attempt is made to write values to them.

11 Manual Tuning of Controllers

Controllers Fitted With Primary Output Only

Before starting to tune a controller, check that the Setpoint Upper Limit (*SPUL*) and Setpoint Lower Limit (*SPLL*) are set to safe levels.

The following simple technique may be used to determine values for the Primary Proportional Band (*Pb_P*), Integral Time Constant (*ArSt*) and Derivative Time Constant (*rAtE*).

CAUTION:

This technique is suitable only for processes that are not harmed by large fluctuations in the process variable. It provides an acceptable basis from which to start fine-tuning for a wide range of processes.

1. Set the setpoint to the normal operating process value (or to a lower value if overshoot beyond this value is likely to cause damage).
2. Select On-Off control (i.e. set *Pb_P* = 0).
3. Switch on the process. The process variable will oscillate about the setpoint. Note (a) the Peak-to-Peak variation (*P*) of the first cycle i.e. the difference between the highest value of the first overshoot and the lowest value of the first undershoot, and (b) the time period of the oscillation (*T*) in minutes. See the example diagram below - Manual Tuning.
4. The PID control parameters should then be set as follows:

$$Pb_P = \frac{P}{\text{Input Span}} \times 100$$

$$ArSt = T \text{ minutes}$$

$$rAtE = \frac{T}{6} \text{ minutes}$$

Note:

After setting up the parameters, return the controller to operator mode to prevent unauthorised adjustment of the values.

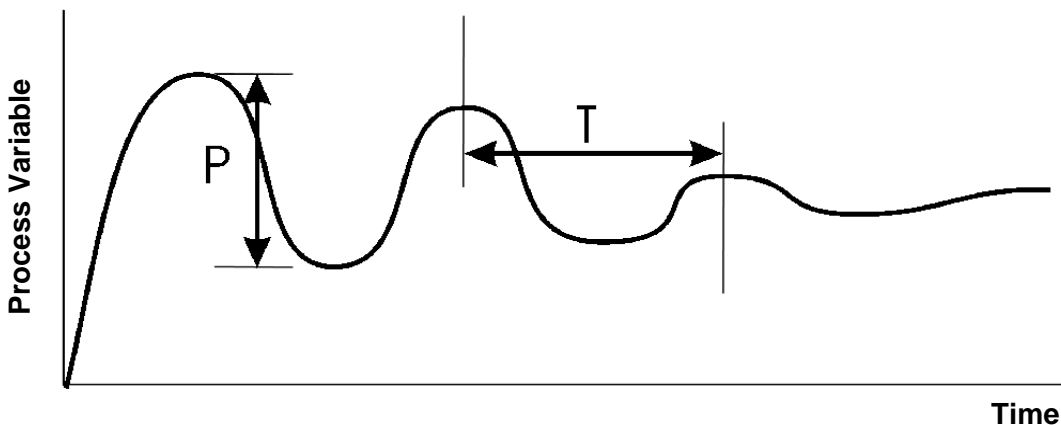

Figure 39. Manual Tuning

Controllers Fitted With Primary and Secondary Outputs

Before starting to tune a controller, check that the Setpoint Upper Limit (SP_{UL}) and Setpoint Lower Limit (SP_{LL}) are set to safe levels.

The following simple technique may be used to determine values for the Primary Proportional Band (Pb_P), Secondary Proportional Band (Pb_S), Integral Time Constant ($ArSt$) and Derivative Time Constant ($rAtE$).

CAUTION:

This technique is suitable only for processes that are not harmed by large fluctuations in the process variable. It provides an acceptable basis from which to start fine-tuning for a wide range of processes.

1. Tune the controller using only the Primary Control output as described in the previous section.
2. Set Pb_S to the same value as Pb_P and monitor the operation of the controller in dual output mode. If there is a tendency to oscillate as the control passes into the Secondary Proportional Band, increase the value of Pb_S . If the process appears to be over-damped in the region of the Secondary Proportional Band, decrease the value of Pb_S .
3. When the PID tuning term values have been determined, if there is a kick to the process variable as control passes from one output to the other, set the Overlap/Deadband parameter to a positive value to introduce some overlap. Adjust this value by trial and error until satisfactory results are obtained.

Manual Fine Tuning.

A separate cycle time adjustment parameter is provided for each time proportioning control output.

Note:

Adjusting the cycle time affects the controllers operation; a shorter cycle time gives more accurate control but electromechanical components such as relays have a reduced life span.

1. Increase the width of the proportional band if the process overshoots or oscillates excessively.
2. Decrease the width of the proportional band if the process responds slowly or fails to reach setpoint.

3. Increase the automatic reset until the process becomes unstable, then decrease until stability has been restored.

Note:

Allow enough time for the controller and process to adjust.

4. Initially add rate at a value between $1/4^{\text{th}}$ and $1/10^{\text{th}}$ of the automatic reset value.
5. Decrease Rate if the process overshoots/undershoots or oscillates excessively.

Note:

Rate can cause process instability.

6. After making all other adjustments, if an offset exists between the setpoint and the process variable use the Bias (manual reset) to eliminate the error:

Below setpoint - use a larger bias value.

Or

Above setpoint - use a smaller bias value.

12 Modbus Serial Communications

All models support the Modbus RTU communication protocol. Some models also support an ASCII communication protocol. Where both Modbus and ASCII are supported, the protocol to be used is selected from Configuration Mode. The RS485 Communications Module must be fitted into Option Slot A in order to use serial communications.

Refer to the relevant Model Group Section for the ASCII and Modbus Application Layer (parameter address/ident information).

For a complete description of the Modbus protocol refer to the description provided at <http://www.modicon.com/> or <http://www.modbus.org/>

Physical Layer

The Base address, bit rate and character format are configured via the front panel in Configuration Mode or by using the PC Configurator software.

Physical layer configuration settings possible are:

Data rate: 1200, 2400, 4800 (default), 9600 and 19,200 bps

Parity: None (default), Even, Odd

Character format: Always 8 bits per character.

The transmitter must not start transmission until 3 character times have elapsed since reception of the last character in a message, and must release the transmission line within 3 character times of the last character in a message.

Note:

Three character times = 1.5ms at 19200, 3ms at 9600, 6ms at 4800, 12ms at 2400 and 24ms at 1200 bps.

Link Layer

A Query (or command) is transmitted from the Modbus Master to the Modbus Slave. The slave instrument assembles the reply to the master. All of the instruments covered by this manual are slave devices, and cannot act as a Modbus Master.

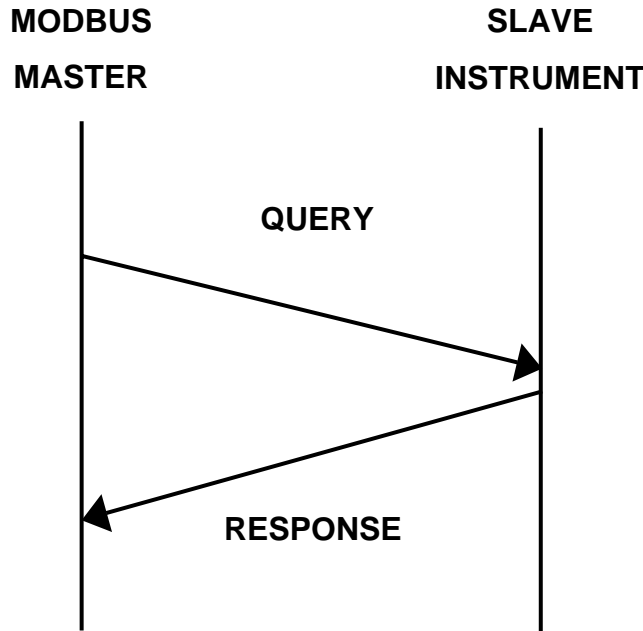

Figure 40. Modbus Link Layer

A message for either a QUERY or RESPONSE is made up of an inter-message gap followed by a sequence of data characters. The inter-message gap is at least 3.5 data character times.

Data is encoded for each character as binary data, transmitted LSB first.

For a QUERY the address field contains the address of the slave destination. The slave address is given together with the Function and Data fields by the Application layer. The CRC is generated from the given address, function and data characters.

For a RESPONSE the address field contains the address of the responding slave. The Function and Data fields are generated by the slave application. The CRC is generated from the address, function and data characters.

The standard MODBUS RTU CRC-16 calculation employing the polynomial $2^{16}+2^{15}+2^2+1$ is used.

Inter-message gap	Address 1 character	Function 1 character	Data <i>n</i> characters	CRC Check 2 characters
-------------------	------------------------	-------------------------	-----------------------------	---------------------------

Device Addressing

The instrument is assigned a unique device address by the user in the range 1 (default) to 255 using the **Addr** parameter in Configuration Mode. This address is used to recognise Modbus Queries intended for this instrument. The instrument does not respond to Modbus Queries that do not match the address that has been assigned to it.

The instrument will also accept global Queries using device address 0 no matter what device address is assigned. No responses are returned for globally addressed Queries.

Supported Modbus Functions

Modbus defines several function types; these instruments support the following types:

Table 26. Supported Modbus Functions

Function Code (decimal)	Modbus Meaning	Description
01 / 02	Read Coil/Input Status	Read output/input status bits at given address.
03 / 04	Read Holding/Input registers	Read current binary value of specified number of parameters at given address. Up to 64 parameters can be accessed with one Query.
05	Force single Coil	Writes a single binary bit to the Specified Slave Bit address.
06	Pre-set Single Register	Writes two bytes to a specified word address.
08	Diagnostics	Used for loopback test.
16	Pre-set Multiple Registers	Writes up to 1 word parameter values to the specified address range.

Function Descriptions

The following is interpreted from the Modbus Protocol Description obtainable from <http://www.modicon.com/> or <http://www.modbus.org/>. Refer to that document if clarification is required.

In the function descriptions below, the preceding device address value is assumed, as is the correctly formed two-byte CRC value at the end of the QUERY and RESPONSE frames.

Read Coil/Input Status (Function 01 / 02)

Reads the content of instruments output/input status bits at the specified bit address.

Table 27. Read Coil/Input Status (Modbus Function 01/02)

QUERY

Function	Address of 1st Bit		Number of Bits	
01 / 02	HI	LO	HI	LO

RESPONSE

Function	Number of Bytes	First 8 bits	2nd 8 Bits
01 / 02			

In the response the “Number of Bytes” indicates the number of data bytes read from the instrument. E.g. if 16 bits of data are returned then the count will be 2. The maximum number of bits that can be read is 16 in one transaction. The first bit read is returned in the least significant bit of the first 8 bits returned.

Read Holding/Input Registers (Function 03 / 04)

Reads current binary value of data at the specified word addresses.

Table 28. Read Holding/Input Registers (Modbus Function 03/04)

QUERY

Function	Address of 1 st Word		Number of Words	
03 / 04	HI	LO	HI	LO

RESPONSE

Function	Number of Bytes	First Word		Last Word	
03 / 04		HI	LO	HI	LO

In the response the “Number of Bytes” indicates the number of data bytes read from the instrument. E.g. if 5 words are read, the count will be 10 (A hex). The maximum number of words that can be read is 64. If a parameter does not exist at one of the addresses read, then a value of 0000h is returned for that word.

Force Single Coil (Function 05)

Writes a single binary value to the Specified Instrument Bit address.

Table 29. Force Single Coil (Modbus Function 05)

QUERY

Function	Address of Bit		State to write	
05	HI	LO	FF/00	00

RESPONSE

Function	Address of Bit		State written	
05	HI	LO	FF/00	00

The address specifies the address of the bit to be written to. The State to write is FF when the bit is to be SET and 00 if the bit is to be RESET.

Note:

The Response normally returns the same data as the Query.

Pre-Set Single Register (Function 06)

Writes two bytes to a specified word address.

Table 30. Pre-Set Single Register (Modbus Function 06)

QUERY

Function	Address of Word		Value to write	
06	HI	LO	HI	LO

RESPONSE

Function	Address of Word		Value written	
06	HI	LO	HI	LO

Note:

The Response normally returns the same data as the Query.

Loopback Diagnostic Test (Function 08)

Table 31. Loopback Diagnostic Test (Modbus Function 08)

QUERY

Function	Diagnostic Code		Value	
08	HI =00	LO=00	HI	LO

RESPONSE

Function	Sub-function		Value	
08	HI=00	LO=00	HI	LO

Note:

The Response normally returns the same data as the Query.

Pre-Set Multiple Registers (Function 10 Hex)

Writes a consecutive word (two-byte) value to the specified address range.

Table 32. Pre-Set Multiple Registers (Modbus Function 10 Hex)

QUERY

Function	1 st Word Address		Number of Words		Number of Query Bytes		First value to write	
10	HI	LO	HI	LO			HI	LO

RESPONSE

Function	1st Word Address		Number of Words	
10	HI	LO	HI	LO

Note:

The number of consecutive words that can be written is limited to 1.

Exception Responses

When a QUERY is sent that the instrument cannot interpret then an Exception RESPONSE is returned. Possible exception responses are:

Table 33. Modbus Exception Responses

Exception Code	Error Condition	Interpretation
00	Unused	None.
01	Illegal function	Function number out of range.
02	Illegal Data Address	Write functions: Parameter number out of range or not supported. (for write functions only). Read Functions: Start parameter does not exist or end parameter greater than 65536.
03	Illegal Data Value	Attempt to write invalid data / required action not executed.

The format of an exception response is:

RESPONSE

Function	Exception Code
Original Function code with its Most Significant Bit (MSB) set.	<i>as detailed above</i>

Note:

In the case of multiple exception codes for a single QUERY the Exception code returned is the one corresponding to the first parameter in error.

13 ASCII Communications

This is a simple ASCII protocol that provides backwards compatibility with previous generations of products. ASCII is not available in all models in the range. The Modbus protocol is recommended for future use.

Refer to the relevant Model Group Section for the ASCII and Modbus Application Layer (parameter address/ident information).

Physical Layer

The Base address, bit rate and character format are configured via the front panel in Configuration Mode or by using the PC Configurator software.

Physical layer configuration settings possible are:

Data rate: 1200, 2400, 4800 (default), 9600 and 19,200 bps

Parity: Even

Character format: 7 bits per character. + 1 stop bit.

The transmitter must not start transmission until 3 character times have elapsed since reception of the last character in a message, and must release the transmission line within 3 character times of the last character in a message.

Note:

Three character times = 1.5ms at 19200, 3ms at 9600, 6ms at 4800, 12ms at 2400 and 24ms at 1200 bps.

Device Addressing

The instrument is assigned a device address by the user using the **Addr** parameter in Configuration Mode. The address may be set to any unique value from 1 (default) to 99. This address is used to recognise ASCII messages intended for this instrument. The instrument does not respond to messages that do not match the address that has been assigned to it.

Session Layer

The ASCII protocol assumes half duplex communications. The master device initiates all communication. The master sends a command or query to the addressed slave instrument and the slave replies with an acknowledgement of the command or the reply to the query.

Messages from the master device may be one of five types:

- Type 1: {S}{N}??*
- Type 2: {S}{N}{P}{C}* or R{N}{P}{C}*
- Type 3: {S}{N}{P}#{DATA}* or R{N}{P}#{DATA}*
- Type 4: {S}{N}{P}I* or R{N}{P}I*
- Type 5: {S} {N} \ P S S ? *

All characters are in ASCII code. See the following Parameter Key table for details of the parameters in brackets { }.

Table 34. ASCII Parameter Key

- {S}** is the Start of Message character L (Hex 4C) or R (Hex 52).
L is used for Controllers; R is used for Profilers.
- {N}** is the slave device address (in the range 1 - 99); addresses 1 - 9 may be represented by a single digit (e.g. 7) or in two-digit form, the first digit being zero (e.g. 07).
- {P}** is a character which identifies the parameter to be interrogated/modified.
- {C}** is the command (Refer to the Serial Communications Application Layer information for each Model Group)
- #** indicates that {DATA} is to follow (Hex 23)
- {DATA}** is a string of numerical data in ASCII code (refer to the Data Element table below)
- P** is the Program Number
- S S** is the Segment Number (01 to 16)
- *** is the End of Message Character (Hex 2A)

No space characters are permitted in messages. Any syntax errors in a received message will cause the slave instrument to issue no reply and await the Start of Message character.

Table 35. ASCII Data Element – Sign/Decimal Point Position

{DATA} Content	Data Format	Description
abcd0	+abcd	Positive value, no decimal place
abcd1	+abc.d	Positive value, one decimal place
abcd2	+ab.cd	Positive value, two decimal places
abcd3	+a.bcd	Positive value, three decimal places
Abcd5	- abcd	Negative value, no decimal place
Abcd6	- abc.d	Negative value, one decimal place
Abcd7	- ab.cd	Negative value, two decimal places
Abcd8	- a.bcd	Negative value, three decimal places

(in the Data Content, abcd represents the data value, the last digit indicates data format)

Type 1 Message

L {N} ? ? *

This message is used by the master device to determine whether the addressed slave device is active.

The reply from an active slave is

L {N} ? A *

An inactive device will give no reply.

Type 2 Message

L {N} {P} {C} * or R {N} {P} {C} *

This type of message is used by the master device, to interrogate or modify a parameter in the addressed slave device. {P} identifies the parameter and {C} represents the command to be executed, which may be one of the following:

- + (Hex 2B) = Increment the value of the parameter defined by {P}
- (Hex 2D) = Decrement the value of the parameter defined by {P}
- ? (Hex 3F) = Determine the current value of the parameter defined by {P}

The reply from the addressed slave device is of the form:

L {N} {P} {DATA} A * or R {N} {P} {DATA} A *

where {DATA} comprises five ASCII-coded digits whose format is shown in the Data Element table above. The data is the value requested in a query message or the new value of the parameter after modification. If the action requested by the message from the master device would result in an invalid value for that parameter (either because the requested new value would be outside the permitted range for that parameter or because the parameter is not modifiable), the slave device replies with a negative acknowledgement:

L {N} {P} {DATA} N * or R {N} {P} {DATA} N *

The {DATA} string in the negative acknowledgement reply will be indeterminate. If the process variable or the deviation is interrogated whilst the process variable is outside the range of the slave device, the reply is:

L {N} {P} < ? ? > 0 A *

if the process variable is over-range, or

L {N} {P} < ? ? > 5 A *

if the process variable is under-range.

Type 3 Message

L {N} {P} # {DATA} * or R {N} {P} # {DATA} *

This message type is used by the master device to set a parameter to the value specified in {DATA}. The command is not implemented immediately by the slave device; the slave will receive this command and will then wait for a Type 4 message (see below). Upon receipt of a Type 3 message, if the {DATA} content and the specified parameter are valid, the slave device reply is of the form:

L {N} {P} {DATA} I * or R {N} {P} {DATA} I *

(where I = Hex 49) indicating that the slave device is ready to implement the command. If the parameter specified is invalid or is not modifiable or if the desired value is outside the permitted range for that parameter, the slave device replies with a negative acknowledgement in the form:

L {N} {P} {DATA} N * or R {N} {P} {DATA} N *

Type 4 Message

L {N} {P} I * or R {N} {P} I *

This type of message is sent by the master device to the addressed slave device, following a successful Type 3 transaction with the same slave device. Provided that the **{DATA}** content and the parameter specified in the preceding Type 3 message are still valid, the slave device will then set the parameter to the desired value and will reply in the form:

L {N} {P} {DATA} A *

where **{DATA}** is the new value of the parameter. If the new value or parameter specified is invalid, the slave device will reply with a negative acknowledgement in the form:

L {N} {P} {DATA} N *

where **{DATA}** is indeterminate. If the immediately preceding message received by the slave device was not a Type 3 message, the Type 4 message is ignored.

Error Response

The circumstances under which a message received from the master device is ignored are:

- Parity error detected
- Syntax error detected
- Timeout elapsed
- Receipt of a Type 4 message without a preceding Type 3 command message.

Negative acknowledgements will be returned if, in spite of the received message being notionally correct, the slave device cannot supply the requested information or perform the requested operation. The **{DATA}** element of a negative acknowledgement will be indeterminate.

14 Calibration Mode

WARNING:

CALIBRATION IS ONLY REQUIRED FOR INSTRUMENTS IN WHICH CALIBRATION ERRORS HAVE BEEN ENCOUNTERED. REFER TO CALIBRATION CHECK BELOW.

CAUTION:

Calibration must be performed by personnel who are technically competent and authorised to do so.

Calibration is carried out during manufacture and is not normally required again during the lifetime of an instrument.

Equipment Required For Checking or Calibrating the Universal Input

A suitable calibration signal source is required for each input type. To verify the accuracy of the instrument or carry out recalibration, the listed input sources are required, with better than $\pm 0.05\%$ of the reading accuracy:

1. DC linear inputs: 0 to 50mV, 0 to 10VDC and 0 to 20mADC.
2. Thermocouple inputs - complete with 0°C reference facility, appropriate thermocouple functions and compensating leads (or equivalent).
3. RTD inputs: decade resistance box with connections for three-wire input (or equivalent).

Calibration Check

1. Set the instrument to the required input type.
2. Power up the instrument and connect the correct input leads.
Leave powered up for at least five minutes for RTD and DC linear inputs, or at least 30 minutes for thermocouple inputs.
3. After the appropriate delay for stabilisation has elapsed, check the calibration by connecting the appropriate input source and checking a number of cardinal points.
4. Repeat the test for all required input types.

Recalibration Procedure

Recalibration is carried out in five phases as shown in the table below, each phase corresponds to an input range of the instrument.

CAUTION:

The 50mV phase MUST be calibrated before the thermocouple range.

Table 36. Input Calibration phases

iP_1	50 mV
iP_2	10 V
iP_3	20 mA
iP_4	RTD input (200 ohm)
iP_5	Thermocouple (K type source at 0°C required)

To start calibration, apply the required calibration input from the source type list above, using the correct connections,

1. Whilst the instrument is powering up, press and together until **iP_1** is displayed.

Note:

If a phase has not been previously calibrated the display will flash.

2. Press to initiate calibration on PID Controllers, or
 Press to initiate calibration on Limit Controllers, or
 Press and together to initiate calibration on Indicators.
3. During calibration the display changes to **----** for a few seconds.
4. If the input is misconnected or an incorrect signal is applied the calibration will be aborted and the display will shown **FR iL**. The previous calibration value will be retained.
5. If the calibration has succeeded, the pass display is shown **iP_1** (non-flashing).
6. Press to step onto the next phase.
7. Repeat this process for each input type until all the phases are calibrated.

Note:

*Switch off the instrument to exit the Calibration Mode.
 Calibration Mode automatically exits if there is no button activity for five minutes.*

15 Appendix 1 – Glossary

This Glossary explains the technical terms and parameters used in this manual. The entry type is also shown:

<i>General Definition:</i>	Terms applicable to the entire model range.
<i>Controller Definition:</i>	Terms applicable to controller models only.
<i>Limit Controller Definition:</i>	Terms applicable to limit controller models only.
<i>Indicator Definition:</i>	Terms applicable to indicator models only.
<i>General Parameter:</i>	Parameters applicable to the entire model range.
<i>Controller Parameter:</i>	Parameters applicable to controller models only.
<i>Controller Tuning Parameter:</i>	Parameters relating to the tuning of controller models
<i>Indicator Parameter:</i>	Parameters applicable to indicator models only.

Active Setpoint

Type: *Controller Definition*

Active Setpoint is the setpoint used as the current target SP value. Some controllers can have more than one setpoint, but only one of these is active at any time.

Also refer to Remote Setpoint, Setpoint, Setpoint Select and Setpoint Select Enable.

Actual Setpoint

Type: *Controller Definition*

Actual Setpoint is the current value of the setpoint. This may be different to the Active Setpoint's target value if the setpoint is currently ramping. The actual setpoint will rise/fall at the ramp rate set, until it reaches the target setpoint value.

Also refer to Active Setpoint, Setpoint, Setpoint Ramp Enable and Setpoint Select.

Alarm Hysteresis

Type: *General Parameter*

An adjustable band on the “safe” side of an alarm point, through which the process variable must pass before the alarm will change state, as shown in the diagram below. E.g. a high alarm’s hysteresis band is below the high alarm value, and a low alarm’s hysteresis is above the low alarm value.

Also refer to *Alarm Operation*.

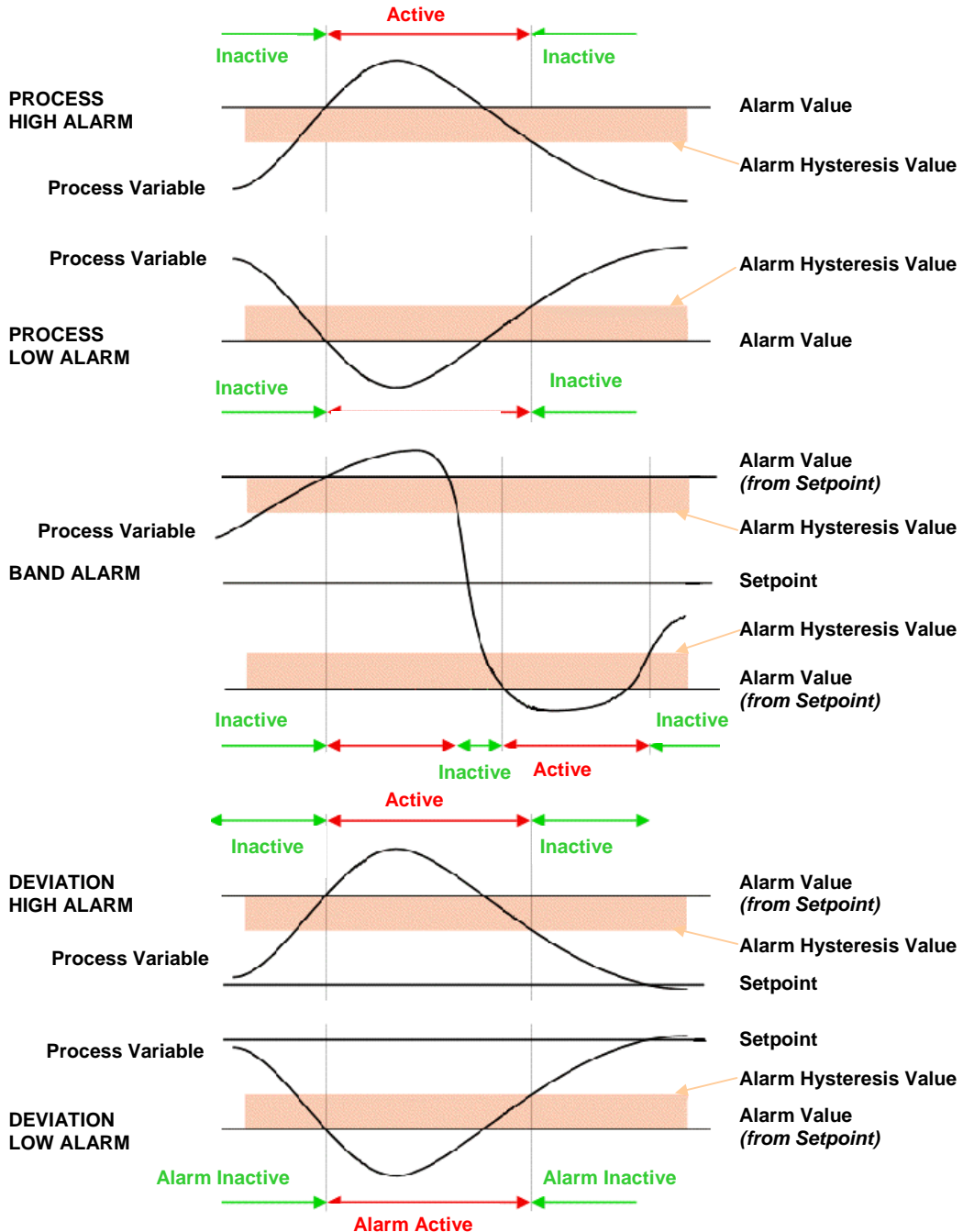

Figure 41. Alarm Hysteresis Operation

Alarm Operation

Type: General Definition

The different alarm types are shown below, together with the action of any outputs. Also refer to *Alarm Hysteresis, Alarm Inhibit, Band Alarm, Deviation Alarm, Latching Relay, Logical Alarm Combinations, Loop Alarm, Process High Alarm and Process Low Alarm.*

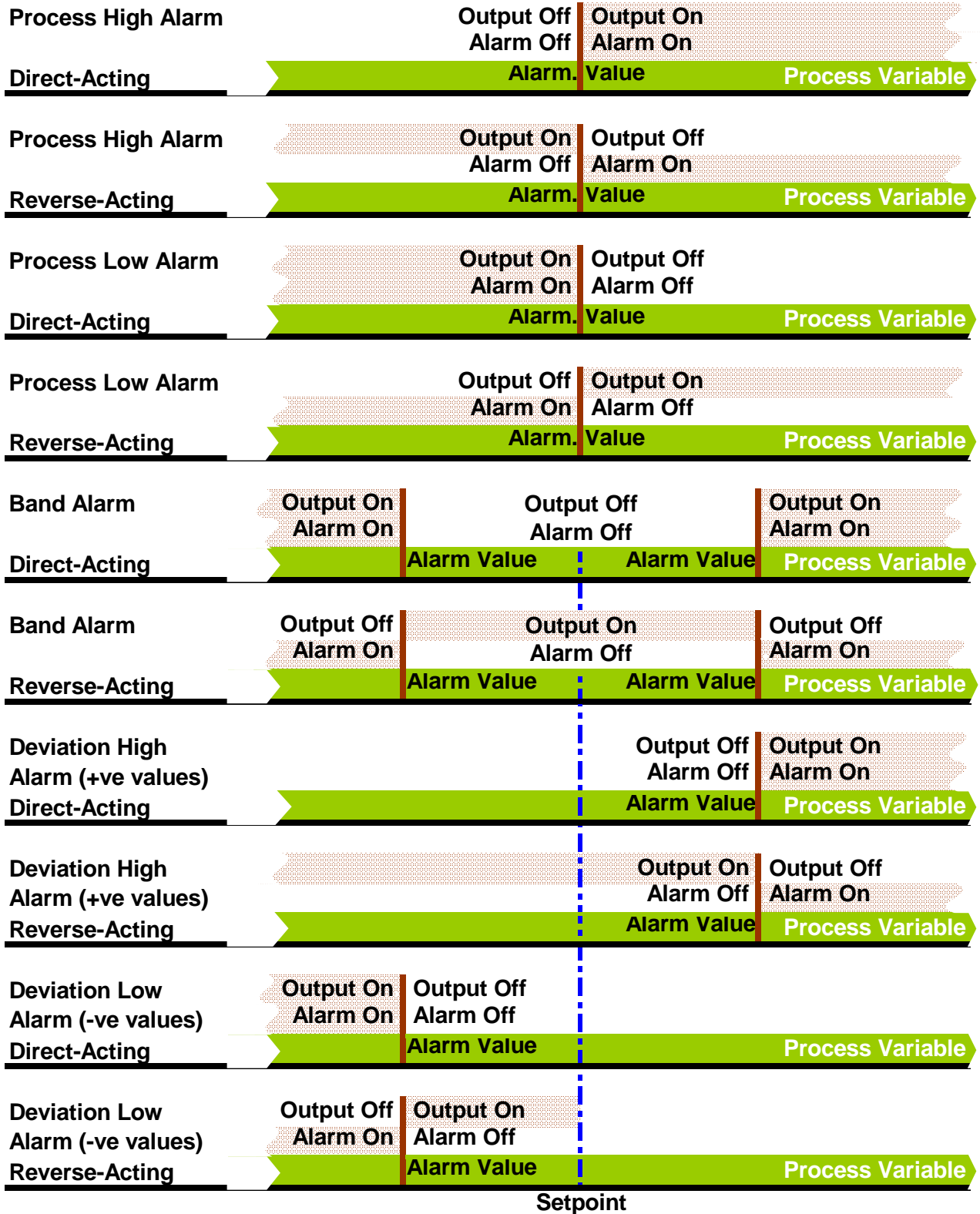

Figure 42. Alarm Operation

Alarm InhibitType: *General Parameter*

Inhibits an alarm at power-up or when the controller Setpoint is switched, until that alarm goes inactive. The alarm operates normally from that point onwards.

Also refer to Alarm Operation.

AnnunciatorType: *Limit Controller Definition*

A special type of alarm output that is linked to a Limit Controller's main Limit Output. An Annunciator output will activate when an Exceed condition occurs, and will remain active until a reset instruction is received, or the Exceed condition has passed. Unlike the Limit Output, an Annunciator can be reset even if the Exceed condition is present.

Also refer to Exceed Condition, Latching Relay, Limit Controller, Limit Hysteresis and Limit Setpoint

Automatic Reset (Integral)Type: *Controller Tuning Parameter*

Used to automatically bias the proportional output(s) to compensate for process load variations. It is adjustable in the range 1 seconds to 99 minutes 59 seconds per repeat and OFF (value greater than 99 minutes 59 seconds - display shows **OFF**). Decreasing the time increases the Integral action. This parameter is not available if the primary output is set to On-Off.

Display code = **ARSt**, default value = five minutes and zero seconds (**5.00**).

Also refer to Primary Proportional Band, Secondary Proportional Band, Rate, PID, and Tuning.

Auto Pre-TuneType: *Controller Tuning Parameter*

Determines whether the Auto Pre-Tune feature is activated on power up (**d iSA** = disabled, **EnAb** = enabled). Auto Pre-Tune is useful when the process to be controlled varies significantly each time it is run. Auto Pre-Tune ensures that tuning occurs at the start of the process. Self-Tune may also be engaged to fine tune the controller.

Display code = **APt**, default setting = **d iSA**.

Also refer to Pre-Tune, Self-Tune and Tuning.

Band Alarm 1 ValueType: *General Parameter*

This parameter is applicable only if Alarm 1 is selected to be a Band Alarm. It defines a band of process variable values, centred on the current actual setpoint value. If the process variable value is outside this band, the alarm will be active. This parameter may be adjusted from 1 to full span from the setpoint.

Display code = **bAL 1**, default value = 5.

Also refer to Alarm Operation, Band Alarm 2 Value and Input Span.

Band Alarm 2 ValueType: *General Parameter*

This parameter, is similar to the Band Alarm 1 Value. It is applicable only if Alarm 2 is selected to be a Band Alarm.

Display code = **bAL 2**, default value = 5.

Also refer to Alarm Operation, Band Alarm 1 Value and Input Span.

Bias (Manual Reset)

Type: *Controller Tuning Parameter*

Used to manually bias the proportional output(s) to compensate for process load variations. Bias is expressed as a percentage of output power and is adjustable in the range 0% to 100% (for Primary Output alone) or -100% to +100% (for both Primary and Secondary Outputs). This parameter is not applicable if the Primary output is set to ON/OFF control mode. If the process settles below setpoint use a higher Bias value to remove the error, if the process variable settles above the setpoint use a lower Bias value. Lower Bias values will also help to reduce overshoot at process start up.

Display code = **b RS**, default value = 25%.

Also refer to *ON/OFF Control and PID*.

Bumpless Transfer

Type: *Controller Definition*

A method used prevent sudden changes to the output power level when switching between Automatic and Manual control modes. During a transition from Automatic to Manual, the initial Manual Power value will be set to equal the previous automatic mode value. The operator can then adjust the value as required. During a transition from Manual to Automatic, the initial Automatic Power value will be set to equal the previous manual mode value. The correct power level will gradually applied by the control algorithm.

Also refer to *Manual Mode*.

Cascade Control

Type: *Controller Definition*

Applications with two or more capacities (such as heated jackets) are inherently difficult for a single instrument to control, due to large overshoots and unacceptable lags. The solution is to cascade two or more controllers, each with its own input, in series forming a single regulating device. The product setpoint temperature is set on the master controller. This is compared to the product temperature, and the master's PID output (mA or VDC) is fed into a remote setpoint input on the slave. The RSP is scaled to suit any expected temperature. The slave loop's natural response time should ideally be at least 5 times faster than the master.

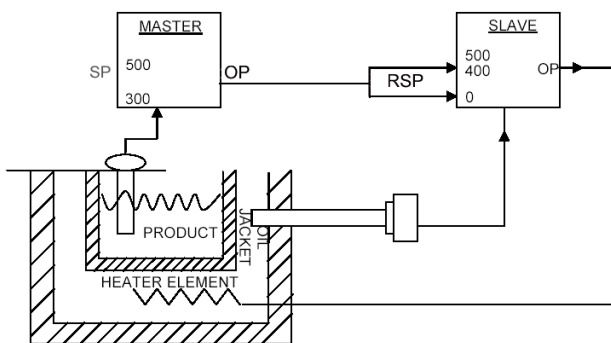

In the example, the maximum input represents 400°C, thus restricting the jacket temperature. At start-up the master compares the product temperature (ambient) to its setpoint (300°C) and gives maximum output. This sets the maximum (400°C) setpoint on the slave, which is compared to the jacket temperature (ambient) giving maximum heater output.

As the jacket temperature rises, the slave's heater output falls. The product temperature also rises at a rate dependant on the transfer lag between the jacket and product. This causes the master's PID output to decrease, reducing the 'jacket' setpoint on the slave, effectively reducing the output to the heater. This continues until the system becomes balanced.

When tuning, first set the master to manual mode. Tune the slave controller using proportional control only (I & D are not normally required) then return the master to automatic mode before tuning the master. The result is quicker, smoother control with minimum overshoot and the ability to cope with load changes, whilst keeping the jacket temperature within acceptable tolerances.

Also refer to *Manual Mode, Master & Slave, PID, Remote Setpoint, Remote Setpoint Lower Limit, Remote Setpoint Upper Limit, Setpoint, Setpoint Select and Tuning*.

Communications Write EnableType: *General Definition*

Enables/disables the changing of parameter values via the RS485 communications link, if the communications option is installed.

Possible settings are read only or read/write.

Display code = **CoEn**, default setting = **r - LW** (read/write).

ControllerType: *Controller Definition*

An instrument that can control a Process Variable, using either PID or On-Off control methods. Alarm outputs are also available that will activate at preset PV values, as are other options such as PV retransmission and Serial Communications.

Also refer to Alarm Operation, Indicator, Limit Controller, On-Off Control, PID, Process Variable, Retransmit Output and Serial Communications.

CPUType: *General Definition*

This stands for Central Processing Unit and refers to the onboard microprocessor that controls all of the measuring, alarm and control functions of the instrument.

Current Proportioning ControlType: *Controller Definition*

Current proportioning control can be implemented on units configured with linear current or voltage output(s). It provides a 4 to 20mA, 0-20mA, 0 to 5V, 0 to 10V or 2 - 10V DC PID output. On-Off control should not be used with Current proportioning control.

Also refer to On-Off Control, PID, Primary Proportional Band, Rate, Secondary Proportional Band and Time Proportional Control.

Cycle TimeType: *Controller Definition*

For time proportioning outputs, it is used to define time period over which the average on vs. off time is equal to the required PID output level. **Ct 1**, **Ct 2** and **Ct 3** are available when option slots 1, 2 or 3 are defined as time proportioning output types. The permitted range of value is 0.5, 1, 2, 4, 8, 16, 32, 64, 128, 256 or 512 seconds. Shorter cycle times will give better control, but at the expense of reduce life when used with an electromechanical control device (e.g. relays or solenoid valves).

Display codes = **Ct 1**, **Ct 2** and **Ct 3**, default value = 32.

Also refer to PID and Time Proportioning.

DeadbandType: *Controller Parameter*

- Refer to *Overlap/Deadband*.

DerivativeType: *Controller Parameter*

- Refer to *Rate*.

Deviation Alarm 1 Value TypeType: *General Parameter*

This is applicable only if Alarm 1 is selected to be Deviation Alarm. A positive value (Deviation High) sets the alarm point above the current actual setpoint, a negative value (Deviation Low) sets it below. If the process variable deviates from the setpoint by a margin greater than this value, alarm 1 becomes active.

Display code = **dAL 1**, Default value = 5.

Also refer to Alarm Operation and Deviation Alarm 2 Value.

Deviation Alarm 2 ValueType: *General Parameter*

Applicable only if Alarm 2 is selected as a Deviation Alarm. It is similar to Deviation Alarm 1 Value.

Display code = **dAL2**. Default value = 5.

Also refer to *Alarm Operation and Deviation Alarm 1 Value*.

Differential (On-Off Hysteresis)Type: *Controller Parameter*

A switching differential used when one or both control outputs have been set to On-Off. This parameter is adjustable within the range 0.1% to 10.0% of input span; the default value is 0.5%. The differential band is centred about the setpoint.

Relay chatter can be eliminated by proper adjustment of this parameter. Too large a value for this parameter will increase amplitude of oscillation in this process variable.

Display code = **d iFP** for primary only differential, **d iFS** for secondary only differential & **d iFF** for primary and secondary differential.

Also refer to *Input Span and On-Off Control*.

Direct/Reverse Operation of Control OutputsType: *Controller Definition*

Direct operation is typically used with cooling applications; On-Off direct outputs will turn on when the process variable exceeds setpoint. Proportional direct outputs will increase the percentage of output as the process value increases within the proportional band. Reverse operation is typically used with heating applications; On-Off reverse outputs will turn off when the process variable exceeds setpoint. Proportional reverse outputs will decrease the percentage of output as the process value increases within the proportional band. The Secondary Output will be direct whenever the Primary Output is selected as reverse. The Secondary Output will be reverse whenever the Primary Output is selected as direct.

Also refer to *On-Off Control, PID, Primary Proportional Band and Secondary Proportional Band*

Display StrategyType: *General Parameter*

Alters the parameters displayed in normal operator mode. For example a controller could display PV + SP, PV + adjustable SP, PV + Ramping SP, PV only or SP only. Display strategy 6 will allow read only access to the setpoint values in Operator Mode, Setup Mode must then be entered to change the setpoint.

Display code = **d iSP**

Also refer to *Process Variable, Setpoint and Setpoint Ramping*.

Elapsed TimeType: *Indicator Definition*

The total accumulated time that Alarm 1 has been active on an Indicator since this parameter was last reset. This does not include the time when the alarm condition has cleared. The Elapsed Time is not affected by the Alarm 2 and Alarm 3 status.

Also refer to *Alarm Operation, Exceed Time and Indicator*.

Exceed ConditionType: *Limit Controller Definition*

A state that occurs when the Process Variable exceeds the Limit Setpoint value. E.g. if the PV is above the Limit SP when set for high limit action, or below the Limit SP for low limit action. The Limit Controller will shut down the process when this condition occurs, and cannot be reset until the Exceed Condition has passed.

Also refer to *Annunciator, Exceed Time, Latching Relay, Limit Controller, Limit Hysteresis and Limit Setpoint*.

Exceed TimeType: *Limit Controller Definition*

The total accumulated time that a Limit Controller has been in the Exceed Condition since this parameter was last reset.

Also refer to *Elapsed Time, Exceed Condition and Limit Controller*.

IndicatorType: *Indicator Definition*

An instrument that can display a Process Variable. Alarm outputs are available that will activate at preset PV values. Relay outputs can be selected to have a Latching function similar to a Limit Controller output, but indicators do not have the necessary approvals for safety critical applications. Other options are PV retransmission and Serial Communications. Process control functions are not available.

Also refer to *Alarm Operation, Controller, Elapsed Time, Latching Relay, Limit Controller, Multi-Point Scaling, Process Variable, Retransmit Output, Serial Communications, Tare*.

Input Filter Time ConstantType: *General Parameter*

This parameter is used to filter out extraneous impulses on the process variable. The filtered PV is used for all PV-dependent functions (display control, alarm etc). The time constant is adjustable from 0.0 seconds (off) to 100.0 seconds in 0.5 second increments.

Display code = **F ILT**, Default value = 2.0 seconds.

Also refer to *Process Variable*.

Input RangeType: *General Definition*

This is the overall process variable input range and type as selected by the **INPT** parameter in Configuration Mode.

Also refer to *Input Span*.

Input SpanType: *General Definition*

The measuring limits, as defined by the Scale Range Lower and Scale Range Upper Limits. The trimmed span value is also used as the basis for calculations that relate to the span of the instrument (E.g. controller proportional bands)

Also refer to *Input Range, Scale Range Lower Limit and Scale Range Upper Limit*.

IntegralType: *Controller Tuning Parameter*

Refer to *Automatic Reset*.

Latching RelayType: *General Definition*

A type of relay that, once it becomes active, requires a reset signal before it will deactivate. This output is available on Limit controllers and indicator alarms. To successfully deactivate a latched relay, the alarm or limit condition that caused the relay to become active must first be removed, then a reset signal can be applied. This signal may be applied from the instrument keypad, Digital Input or command via Serial Communication.

Also refer to *Alarm Operation, Indicator, Limit Controller, Limit Hysteresis, Serial Communications*.

LEDType: *General Definition*

Light Emitting Diode. LED's are used as indicator lights (e.g. for the alarm indication). The upper and lower 7-segment displays are also LED's.

Limit ControllerType: *Limit Controller Definition*

A protective device that will shut down a process at a preset Exceed Condition, in order to prevent possible damage to equipment or products. A fail-safe latching relay is used, which cannot be reset by the operator until the process is back in a safe condition. This signal may be applied from the instrument keypad, Digital Input or command via Serial Communication. Limit controllers work independently of the normal process controller. Limit Controllers have specific approvals for safety critical applications. They are recommended for any process that could potentially become hazardous under fault conditions.

Also refer to Annunciator, Controller, Exceed Condition, Exceed Time, Latching Relay, Limit Hysteresis, Limit Setpoint and Serial Communications.

Limit HysteresisType: *Limit Controller Definition*

An adjustable band on the “safe” side of the Limit Setpoint. For a high limit, the hysteresis band is below the limit setpoint value, for a low limit, the hysteresis is above the limit setpoint value. The latching limit relay cannot be reset by the operator until the process has passed through this band

Also refer to Exceed Condition, Latching Relay, Limit Controller and Limit Setpoint.

Limit SetpointType: *Limit Controller Definition*

The preset value at which an Exceed Condition will occur. When a Limit Controller has been set for High Limit control action, the Exceed Condition is above the Limit Setpoint. When a Limit Controller has been set for Low Limit control action, the Exceed Condition is below the Limit Setpoint.

Also refer to Annunciator, Exceed Condition, Limit Hysteresis, Limit Controller and Setpoint.

Lock CodesType: *General Parameter*

Defines the four-digit codes required to enter Configuration (20), Set-Up (10), and Auto Tuning (0) modes.

Display codes = **cLoc**, **SLoc** and **tLoc**, default values shown above in brackets.

Logical Combination of Alarms

Type: *General Definition*

Two alarms may be combined logically to create an AND/OR situation. Any suitable output may be assigned as a Logical Alarm Output, configured for Reverse-acting or Direct action. *Also refer to Alarm Operation*

Table 37. Logical Alarm Outputs

Logical OR: Alarm 1 OR Alarm 2											
Direct Acting						Reverse-Acting					
ALARM 1	OFF	ALARM 2	OFF	OUTPUT	OFF	ALARM 1	OFF	ALARM 2	OFF	OUTPUT	ON
	ON		OFF		ON		OFF		OFF		
	OFF		ON		ON		ON		OFF		
	ON		ON		ON		ON		OFF		

Logical AND: Alarm 1 AND Alarm 2											
Direct Acting						Reverse-Acting					
ALARM 1	OFF	ALARM 2	OFF	OUTPUT	OFF	ALARM 1	OFF	ALARM 2	OFF	OUTPUT	ON
	ON		OFF		OFF		ON		ON		
	OFF		ON		OFF		ON		ON		
	ON		ON		ON		ON		OFF		

Loop Alarm Enable

Type: *Controller Parameter*

Enables or disables a loop alarm. A loop alarm is a special alarm, which detects faults in the control feedback loop, by continuously monitoring process variable response to the control output(s). The loop alarm can be tied to any suitable output. When enabled, the loop alarm repeatedly checks if the control output(s) are at the maximum or minimum limit. If an output is at the limit, an internal timer is started: thereafter, if the high output has not caused the process variable to be corrected by a predetermined amount 'V' after time 'T' has elapsed, the loop alarm becomes active. Subsequently, the loop alarm mode repeatedly checks the process variable and the control output(s). When the process variable starts to change value in the correct sense or when the output is no longer at the limit, the loop alarm is deactivated.

For PID control, the loop alarm time 'T' is always twice the Automatic Reset parameter value. For On-Off control, a user defined value for the Loop Alarm Time parameter is used.

The value of 'V' is dependent upon the input type. For Temperature inputs, V = 2°C or 3°F. For Linear inputs, V = 10 least significant display units

Control output limits are 0% for Single output (Primary only) controllers and -100% for Dual output (Primary and Secondary) controllers.

Correct operation of the loop alarm depends upon reasonably accurate PID tuning. The loop alarm is automatically disabled during manual control mode and during execution of the Pre-Tune mode. Upon exit from manual mode or after completion of the Pre-Tune routine, the loop alarm is automatically re-enabled.

Display code = **LAEn**, default value = **d 5A**,

Also refer to Loop Alarm Time, Manual Mode, On-Off Control, Pre-Tune, and Process Variable.

Loop Alarm Time

Type: *Controller Parameter*

When On-Off control is selected and loop alarm is enabled, this parameter determines the duration of the limit condition after which the loop alarm will be activated. It may be adjusted within the range of 1 second to 99 minutes 59 seconds. This parameter is omitted from the Set-up mode display sequence if On-Off control is not selected or loop alarm is disabled.

Display code = **LAt**, Default setting is 99:59.

Also refer to *Loop Alarm Enable*.

mADC

Type: *General Definition*

This stands for milliamp DC. It is used in reference to the DC milliamp input ranges and the linear DC milliamp outputs. Typically, these will be 0 to 20mA or 4 to 20mA.

Manual Mode Enable

Type: *Controller Parameter*

Determines whether operator selection/deselection of manual control is enabled. If the mode is enabled in Set-Up mode, pressing the **AM** key in operator mode will cause a controller to enter or leave manual control mode. In manual mode, the upper display shows the current process value, the lower display shows the output power in the form - **P_{xxx}** (where xxx is equal to the percentage output power). The power value may be adjusted using the UP or DOWN keys. The value can be varied between 0% to 100% for instruments using primary control only, and -100% to +100% for controllers using primary and secondary (e.g. heat & cool). This mode should be used with care because the power output level is set by the operator, therefore the PID algorithm is no longer in control of the process. The operator **MUST** maintain the process as the desired level manually. Manual power is not limited by the Primary Power Output Limit.

Display code = **PoEn**, default setting = **d 5A**.

Also refer to *Bumpless Transfer, PID, and Primary Output Power Limit*

Master & Slave

Type: *Controller Definition*

The terms master & slave are used to describe the controllers in applications where one instrument controls the setpoint of another. The master controller can transmit the setpoint to the slave using an analogue DC linear signal. The slave controller must have a matching a remote setpoint input. Some Profile Controllers can transmit their setpoint via serial communications serial communications. For this method, the Profiler must be able to act as a communications master device and the slave must have a compatible communications option fitted.

Also refer to *Cascade Control, Retransmit Output, Remote Setpoint, Serial Communications, Setpoint*

Multi-Point Scaling Enable

Type: *Indicator Parameter*

When an Indicators Multi-Point Scaling function is enabled by setting **MPs** to **EnAb** in Configuration Mode, up to 9 breakpoints can be defined to linearize the input signal. This only applies to mA, mV or Voltage input types. For each breakpoint, an input scale value is entered, followed by the value to be shown at the breakpoint.

Display code = **MPs**, default setting = **d 5A**.

Also refer to *Indicator, Multipoint Scaling Set Up and Process Variable*.

Multi-Point Scaling Set Up

Type: *Indicator Parameter*

For each breakpoint, the input scale value (ScR_n) is entered as a percentage of the input span, followed by the value to be shown (d,Sn) in display units, for this input value. Each breakpoint's input scale value must be higher than the previous value, but the display values can be either higher or lower. This procedure is repeated for up to nine breakpoints, but if any scale value is set to 100% it automatically becomes the last in the series.

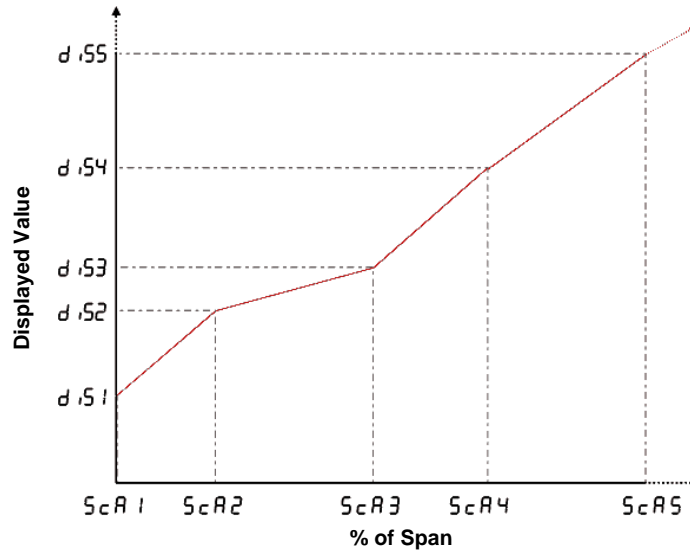

Also refer to *Indicator, Multipoint Scaling Enable and Process Variable*.

Offset

Type: *Controller Parameter*

Offset is used to modify the measured process variable value and is adjustable in the range \pm input span. Use this parameter to compensate for errors in the displayed process variable. Positive values are added to the process variable reading, negative values are subtracted. This parameter is in effect, a calibration adjustment; it MUST be used with care. Injudicious use could lead to the displayed value bearing no meaningful relationship to the actual process variable. There is no front panel indication of when this parameter is in use.

Display value = **OFFS**, default value = 0.

Also refer to *Input Span, Process Variable and Tare*.

On-Off Control

Type: *Controller Definition*

When operating in On-Off control, the output(s) will turn on or off as the process variable crosses the setpoint in a manner similar to a central heating thermostat. Some oscillation of the process variable is inevitable when using On-Off control.

On-Off control can be implemented only with Time Proportioning Control (Relay, Triac or SSR driver output), by setting the corresponding proportional band(s) to zero. On-Off operation can be assigned to the Primary output alone (secondary output not present), Primary and Secondary outputs or Secondary output only (with the primary Output set for time proportional or current proportional control).

Also refer to *Differential, PID, Process Variable, Primary Proportional Band, Secondary Proportional Band, Setpoint and Time Proportioning Control*.

On-Off Differential (Hysteresis)

Type: *Controller Parameter*

- Refer to *Differential*.

Overlap/Deadband

Type: *Controller Parameter*

Defines the portion of the primary and secondary proportional bands ($Pb_P + Pb_S$) over which both outputs are active (Overlap), or neither is active (Deadband). It is adjustable in the range -20% to +20% of the two proportional bands added together. Positive values = Overlap, negative values = Deadband.

This parameter is not applicable if the primary output is set for On-Off control or there is no Secondary Output. If the Secondary Output is set for On-Off, this parameter has the effect of moving the Differential band of the Secondary Output to create the overlap or deadband. When Overlap/Deadband = 0, the "OFF" edge of the Secondary Output Differential band coincides with the point at which the Primary Output = 0%.

Display code = **OL**, default value = 0%.

Also refer to *Differential, On-Off Control, Primary Proportional Band and Secondary Proportional Band*.

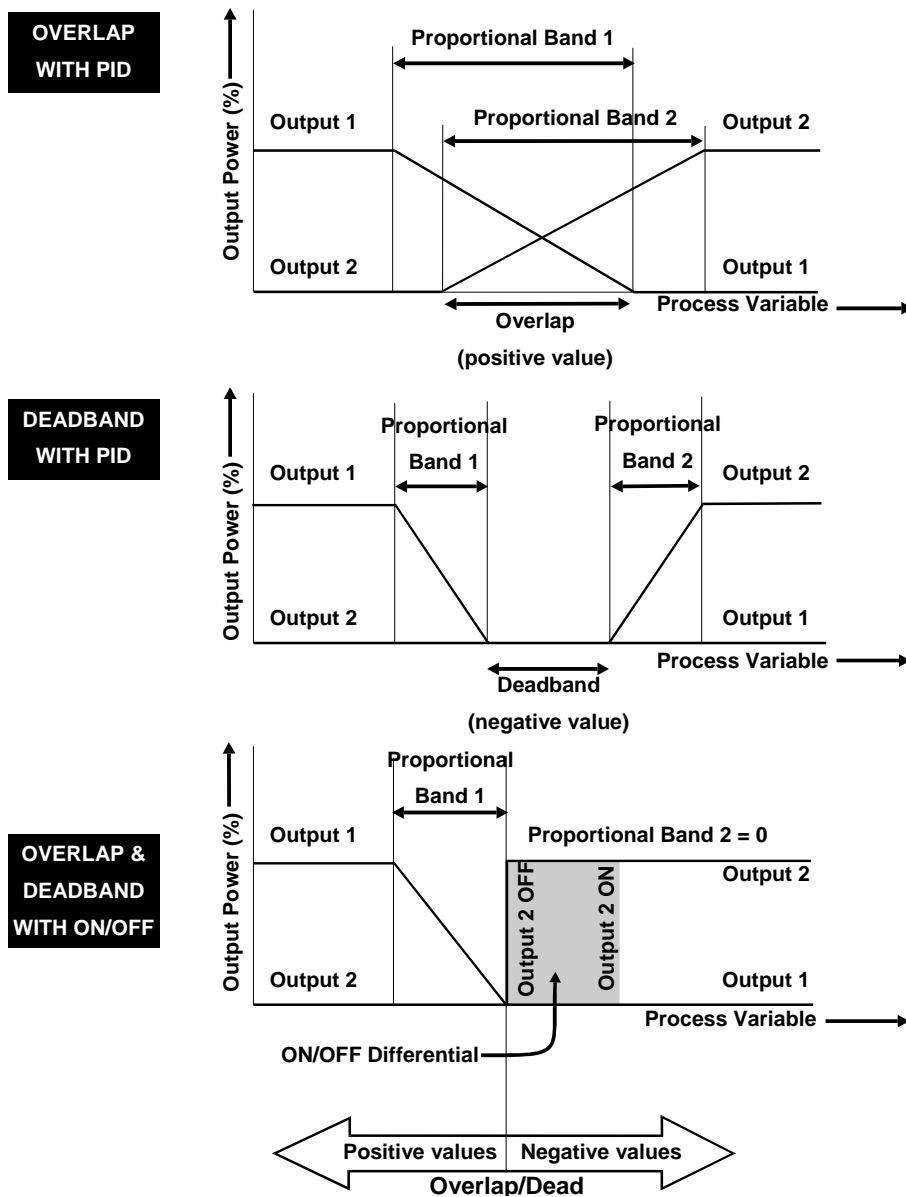

Figure 43. Overlap and Deadband

PIDType: *Controller Definition*

This stands for Proportional Integral and Derivative. A control method that accurately maintains the desired level in a process (e.g. controlling a temperature). It avoids the oscillation characteristic of On-Off control by continuously adjusting the power output level to keep the process variable stable at the desired target setpoint.

Also refer to Automatic Reset, Controller, On-Off Control, Primary Proportional Band, Process Variable, Rate, Secondary Proportional Band, Setpoint and Tuning

PLCType: *General Definition*

This stands for Programmable Logic Controller. A microprocessor based device used in machine control. It is particularly suited to sequential control applications, and uses "Ladder Logic" programming techniques. Some PLC's are capable of basic PID control, but tend to be expensive and often give inferior levels of control.

Also refer to PID.

Pre-TuneType: *Controller Definition*

The Pre-Tune facility artificially disturbs the start-up pattern so that a first approximation of the PID values can be made prior to the setpoint being reached. During Pre-Tune, the controller demands full power until the process value has moved approximately halfway to the setpoint. At that point, power is removed, thereby introducing an oscillation. Once the oscillation peak has passed, the Pre-Tune algorithm calculates an approximation of the optimum PID tuning terms proportional band(s), automatic reset and rate. The process is shown in the diagram below.

When Pre-Tune is completed, the PID control output power is applied using the calculated values. Pre-Tune limits the possibility of setpoint overshoot when the controller is new or the application has been changed. As a single-shot operation, it will automatically disengage once complete, but can be configured to run at every power up using the Auto Pre-Tune function. Pre-Tune will not engage if either primary or secondary outputs on a controller are set for On-Off control, during setpoint ramping or if the process variable is less than 5% of the input span from the setpoint.

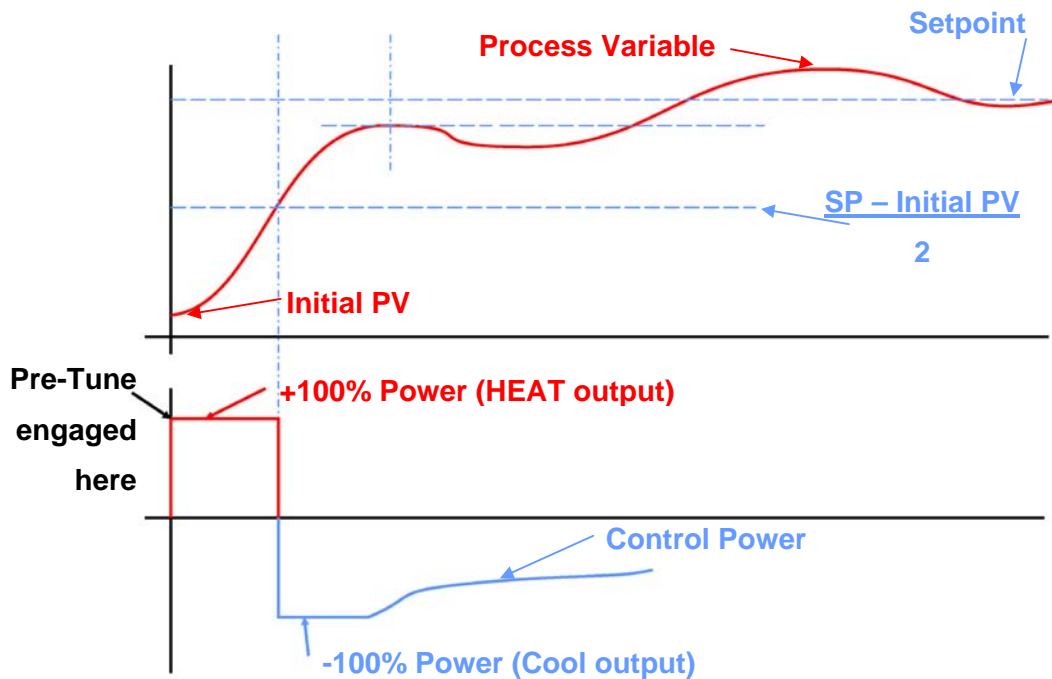

Figure 44. Pre-Tune Operation

Also refer to *Auto Pre-Tune, Automatic Reset, On-Off Control, Input Span, PID, Primary Proportional Band, Process Variable, Rate, Secondary Proportional Band, Self-Tune, Setpoint, Setpoint Ramping and Tuning.*

Primary Output Power Limit

Type: *Controller Parameter*

Used to limit the power level of the Primary Output and may be used to protect the process being controlled. It may be adjusted between 0% and 100%. This parameter is not applicable if the primary output is set for On-Off control.

Display code is **OPh 1**, default value = 100%

Also refer to *On-Off Control.*

Primary Proportional Band

Type: *Controller Tuning Parameter*

The portion of the input span over which the Primary Output power level is proportional to the process variable value. It may be adjusted in the range 0.0% (ON/OFF) to 999.9%. The

Display value = **Pb_P**, default value = 5.0%.

Also refer to *On-Off Control, Input Span, Overlap/Deadband, PID, Secondary Proportional Band, and Tuning.*

Process High Alarm 1 Value

Type: *General Parameter*

This parameter, applicable only when Alarm 1 is selected to be a Process High alarm, defines the process variable value above which Alarm 1 will be active. Its value may be adjusted between Scale Range Upper Limit and Scale Range Lower Limit.

Display code = **PHA 1**, Default value = Scale Range Upper Limit.

Also refer to *Alarm Operation, Process High Alarm 2 Value, Process Variable, Scale Range Lower Limit and Scale Range Upper Limit.*

Process High Alarm 2 ValueType: *General Parameter*

This parameter, applicable only when Alarm 2 is selected to be a Process High alarm. It is similar to the Process High Alarm 1 Value.

Display code = **PHA2**, Default value = Scale Range Upper Limit.

Also refer to Alarm Operation, Process High Alarm 1 Value, Process Variable, Scale Range Lower Limit and Scale Range Upper Limit.

Process Low Alarm 1 ValueType: *General Parameter*

This parameter, applicable only when Alarm 1 is selected to be a Process low alarm, defines the process variable value below which Alarm 1 will be active. Its value may be adjusted between Scale Range Upper Limit and Scale Range Lower Limit.

Display code = **PLA1**, Default value = Scale Range Lower Limit.

Also refer to Alarm Operation, Process Low Alarm 2 Value, Process Variable, Scale Range Lower Limit and Scale Range Upper Limit.

Process Low Alarm 2 ValueType: *General Parameter*

This parameter, applicable only when Alarm 2 is selected to be a Process low alarm. It is similar to the Process Low Alarm 1 Value.

Display code = **PLA2**, default value = Scale Range Lower Limit.

Also refer to Alarm Operation, Process Low Alarm 1 Value, Process Variable, Scale Range Lower Limit and Scale Range Upper Limit.

Process Variable (PV)Type: *General Definition*

Process Variable is the variable to be measured by the primary input of the instrument. The PV can be any parameter that can be converted into a electronic signal suitable for the input. Common types are Thermocouple or PT100 temperature probes, or pressure, level, flow etc from transducers which convert these parameters into linear DC signals (e.g. 4 to 20mA). Linear signals can be scaled into engineering units using the Scale Range Lower Limit and Scale Range Upper Limit parameters.

Also refer to Input Span, Offset, Scale Range Lower Limit and Scale Range Upper Limit.

Process Variable OffsetType: *General Parameter*

- Refer to *Offset*.

Rate (Derivative)Type: *Controller Tuning Parameter*

Rate is adjustable in the range 0 seconds (OFF) to 99 minutes 59 seconds. It defines how the control action responds to the rate of change in the process variable. This parameter should not be used in modulating value applications as it can cause premature wear due to constant small adjustments to the valve position. The Rate parameter is not available if primary control output is set to On-Off.

Display code = **rA~~t~~E**, default value = 1.15.

Also refer to On-Off Control, PID, Process Variable and Tuning.

Remote Setpoint (RSP)Type: *Controller Definition*

An RSP is a secondary analogue input that is used to adjust a controller's setpoint using an external linear DC Voltage or mA input signal, or in some cases potentiometer or mV inputs. The Remote Setpoint value is constrained by the Setpoint Upper Limit and Setpoint Lower Limit settings in the same way as a local setpoint. Typical applications are Master/Slave and Cascade Control.

Display code = **rSP**.

Also refer to Cascade Control, Remote Setpoint Input, Remote Setpoint Lower Limit, Remote Setpoint Upper Limit, Setpoint and Setpoint Select.

Remote Setpoint Input RangeType: *Controller Parameter*

Defines the type and range of the linear input signal (mADC, mVDC, VDC or potentiometer) for the Remote Setpoint. mVDC and potentiometer are only available with Full RSP module.

Display code = **rSP i**.

Also refer to Remote Setpoint and Setpoint.

Remote Setpoint Lower LimitType: *Controller Parameter*

Defines the value of the Remote Setpoint when the RSP input signal is at its minimum value (eg for a 4 to 20mA RSP, the value when 4mA is applied). It may be adjusted within the range -1999 to 9999; (decimal position same as for process variable input). However, the RSP value is always constrained within the Setpoint Upper Limit and Setpoint Lower Limits.

Display code = **rSPL**, default value = PV input range minimum.

Also refer to Remote Setpoint, Remote Setpoint Input, Remote Setpoint Upper Limit, Remote Setpoint Offset, Setpoint and Setpoint Upper Limit and Setpoint Lower Limit.

Remote Setpoint Upper LimitType: *Controller Parameter*

Defines the value of the Remote Setpoint when the RSP input signal is at its maximum value (eg for a 4 to 20mA RSP, the value when 20mA is applied). It may be adjusted within the range -1999 to 9999; (decimal position same as for process variable input). However, the RSP value is always constrained within the Setpoint Upper Limit and Setpoint Lower Limits.

Display code = **rSPu**, default value = PV input range maximum.

Also refer to Remote Setpoint, Remote Setpoint Input, Remote Setpoint Lower Limit, Remote Setpoint Offset, Setpoint and Setpoint Upper Limit and Setpoint Lower Limit.

Remote Setpoint OffsetType: *Controller Parameter*

Used to adjust the Remote Setpoint input value. Positive values are added to the RSP reading, negative values are subtracted. It is adjustable in the range -1999 to 9999, but is constrained within the Scale Range Upper Limit and Scale Range Lower Limit.

Display value = **rSPo**, default value = 0.

Also refer to Remote Setpoint, Scale Range Upper Limit and Scale Range Lower Limit.

Retransmit OutputType: *General Definition*

A linear DC voltage or mA output signal, proportional to the Process Variable or Setpoint, for use by slave controllers or external devices, such as a Data Recorder or PLC. The output can be scaled to transmit any portion of the input or setpoint span.

Also refer to Input Span, Master & Slave, Process Variable and Setpoint.

Retransmit Output 1 Scale MaximumType: *General Parameter*

Scales a linear output module in slot 1 that has been set up to retransmit PV or SP.

Retransmit Scale Maximum defines the value of the process variable, or setpoint, at which the output will be at its maximum value. E.g. for a 0 to 5V output, the value corresponds to 5V. It may be adjusted within the range -1999 to 9999; the decimal position is always the same as that for the process variable input. If this parameter is set to a value less than that for Retransmit Output 1 Scale Minimum, the relationship between the process variable/setpoint value and the retransmission output is reversed.

Display code = **ro 1H**, default value = Scale Range Upper Limit.

Also refer to Process Variable, Retransmit Output, Retransmit Output 1 Scale Minimum, Scale Range Upper Limit and Setpoint.

Retransmit Output 1 Scale MinimumType: *General Parameter*

Scales a linear output module in slot 1 that has been set up to retransmit PV or SP.

Retransmit Scale Minimum defines the value of the process variable, or setpoint, at which the output will be at its minimum value. E.g. for a 0 to 5V output, the value corresponds to 0V. It may be adjusted within the range -1999 to 9999; the decimal position is always the same as that for the process variable input. If this parameter is set to a value greater than that for Retransmit Output Scale Maximum, the relationship between the process variable/setpoint value and the retransmission output is reversed.

Display code = **ro 1L**, default value = Scale Range Lower Limit.

Also refer to Process Variable, Retransmit Output, Retransmit Output 1 Scale Maximum, Scale Range Lower Limit and Setpoint.

Retransmit Output 2 Scale MaximumType: *General Parameter*

Defines the value of the process variable, or setpoint, at which Retransmit Output 2 will be at its maximum value. It is similar to Retransmit Output 1 Scale Maximum.

Display code = **ro 2H**, default value = Scale Range Upper Limit.

Also refer to Process Variable, Retransmit Output, Retransmit Output 2 Scale Minimum, Scale Range Upper Limit and Setpoint.

Retransmit Output 2 Scale MinimumType: *General Parameter*

Defines the value of the process variable, or setpoint, at which Retransmit Output 2 will be at its minimum value. It is similar to Retransmit Output 1 Scale Minimum.

Display code = **ro 2L**, default value = Scale Range Lower Limit.

Also refer to Process Variable, Retransmit Output, Retransmit Output 2 Scale Maximum, Scale Range Lower Limit and Setpoint.

Retransmit Output 3 Scale MaximumType: *General Parameter*

Defines the value of the process variable, or setpoint, at which Retransmit Output 3 will be at its maximum value. It is similar to Retransmit Output 1 Scale Maximum.

Display code = **ro 3H**, default value = Scale Range Upper Limit.

Also refer to Process Variable, Retransmit Output, Retransmit Output 3 Scale Minimum, Scale Range Upper Limit and Setpoint.

Retransmit Output 3 Scale MinimumType: *General Parameter*

Defines the value of the process variable, or setpoint, at which Retransmit Output 3 will be at its minimum value. It is similar to Retransmit Output 1 Scale Minimum.

Display code = **ro3L**, default value = Scale Range Lower Limit.

Also refer to Process Variable, Retransmit Output, Retransmit Output 3 Scale Maximum, Scale Range Lower Limit and Setpoint.

ResetType: *Controller Tuning Parameter*

- Refer to *Automatic Reset*.

Scale Range Upper LimitType: *General Parameter*

For linear inputs, this parameter is used to scale the process variable into engineering units. It defines the displayed value when the process variable input is at its maximum value. It is adjustable from -1999 to 9999 and can be set to a value less than (but not within 100 units of) the Scale Range Lower Limit, in which case the sense of the input is reversed.

For thermocouple and RTD inputs, this parameter is used to reduce the effective range of the input. All span related functions work from the trimmed input span. The parameter can be adjusted within the limits of the range selected by Configuration Mode parameter **inPt**. It is adjustable to within 100 degrees of the Scale Range Lower Limit.

Display code = **rUL**, default value = 1000 for linear inputs or range maximum for temperature inputs.

Also refer to Input Span, Process Variable and Scale Range Lower Limit.

Scale Range Lower LimitType: *General Parameter*

For linear inputs, this parameter can be used to display the process variable in engineering units. It defines the displayed value when the process variable input is at its minimum value. It is adjustable from -1999 to 9999 and can be set to a value more than (but not within 100 units of) the Scale Range Upper Limit, in which case the sense of the input is reversed.

For thermocouple and RTD inputs, this parameter is used to reduce the effective range of the input. All span related functions, work from the trimmed span. The parameter can be adjusted within the limits of the range selected by Configuration Mode parameter **inPt**. It is adjustable to within 100 degrees of the Scale Range Upper Limit.

Display code = **rUL**, default value = 0 for linear inputs, or range minimum for temperature inputs.

Also refer to Input Span, Process Variable and Scale Range Upper Limit.

Secondary Proportional BandType: *Controller Tuning Parameter*

The portion of the input span over which the Secondary Output power level is proportional to the process variable value. It may be adjusted in the range 0.0% (ON/OFF) to 999.9%.

Display value = **Pb_5**, default value = 5.0%.

Also refer to On-Off Control, Input Span, Overlap/Deadband, PID, Primary Proportional Band and Tuning.

Self-TuneType: *Controller Tuning Definition*

Continuously optimises tuning while a controller is operating. It uses a pattern recognition algorithm, which monitors the process error (deviation signal). The diagram shows a typical temperature application involving a process start up, setpoint change and load disturbance.

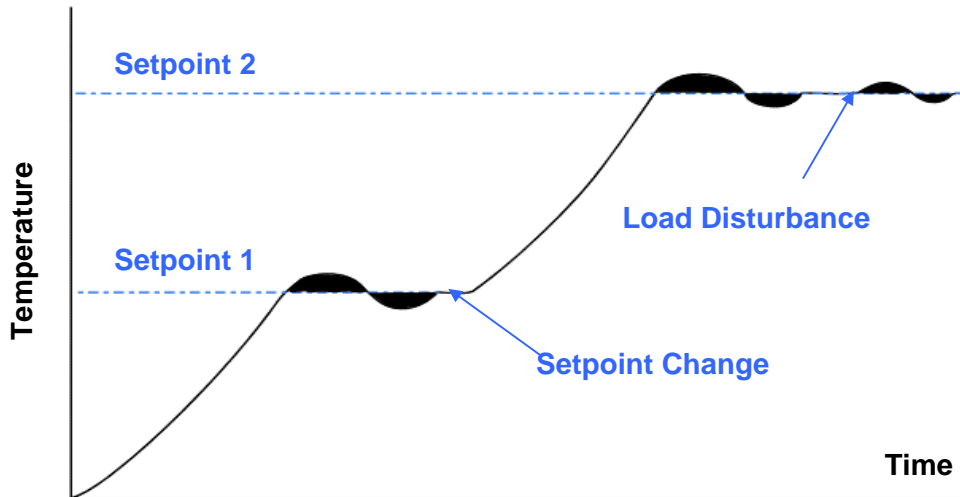

Figure 45. Self-Tune Operation

The deviation signal is shown shaded and overshoots have been exaggerated for clarity. The Self-Tune algorithm observes one complete deviation oscillation before calculating a set of PID values. Successive deviation oscillation causes values to be recalculated so that the controller rapidly converges on optimal control. When the controller is switched off, the final PID terms remain stored in the controller's non-volatile memory, and are used as starting values at the next switch on. The stored values may not always be valid, if for instance the controller is brand new or the application has been changed. In these cases the user can utilise Pre-Tune to establish new initial values.

Use of continuous self-tuning is not always appropriate for applications which are frequently subjected to artificial load disturbances, for example where an oven door is likely to be frequently left open for extended periods of time. Self-Tune cannot be engaged if a controller is set for On-Off Control.

Also refer to On-Off Control, Pre-Tune, PID, and Tuning.

Serial Communications OptionType: *General Definition*

An feature that allows other devices such as PC's, PLC's or a master controller to read or change an instruments parameters via an RS485 Serial link. Full details can be found in the Serial Communications sections of this manual.

Also refer to Controller, Indicator, Master & Slave, Limit Controller and PLC

SetpointType: *Controller Definition*

The target value at which a controller will attempt to maintain the process variable by adjusting its power output level. Controllers can have either one or two setpoints. These can be one or two local internal setpoints (**SP** or **SP 1** and **SP 2**), or one local internal setpoint (**LSP**) and one externally adjusted remote (**rSP**) setpoint, if a Remote Setpoint module is fitted. The value of the setpoints can be adjusted between the Setpoint Upper Limit and Setpoint Lower Limits. The active setpoint is defined by the status of the Setpoint Select parameter or a digital input.

Also refer to Limit Setpoint, Process Variable, Remote Setpoint, Scale Range Lower Limit, Setpoint Lower Limit, Setpoint Upper Limit and Setpoint Select

Setpoint Upper LimitType: *Controller Parameter*

The maximum limit allowed for operator setpoint adjustments. It should be set to keep the setpoint below a value that might cause damage to the process. The adjustment range is between Scale Range Upper Limit and Scale Range Lower Limit. The value cannot be moved below the current value of the setpoint.

Display code = **SPuL**, default value is Scale Range Upper Limit.

Also refer to Scale Range Lower Limit, Scale Range Upper Limit, Setpoint and Setpoint Lower Limit.

Setpoint Lower LimitType: *Controller Parameter*

The minimum limit allowed for operator setpoint adjustments. It should be set to keep the setpoint above a value that might cause damage to the process. The adjustment range is between Scale Range Lower Limit and Scale Range Upper Limit. The value cannot be moved above the current value of the setpoint.

Display code = **SPLL**, default value = Scale Range Lower Limit.

Also refer to Scale Range Lower Limit, Scale Range Upper Limit, Setpoint and Setpoint Upper Limit.

Setpoint Ramping EnableType: *Controller Parameter*

Enables or disables the viewing and adjustment of the Setpoint Ramp Rate in Operator Mode. This parameter does not disable the ramping SP feature; it merely removes it from Operator Mode. It can still be viewed and adjusted in Setup Mode. To turn off ramping, the ramp rate must be set to OFF (*blank*).

Display code = **SPr**, default setting = Disabled.

Also refer to Process Variable, Setpoint and Setpoint Ramp Rate.

Setpoint Ramp RateType: *Controller Parameter*

The rate at which the actual setpoint value will move towards its target value, when the setpoint value is adjusted or the active setpoint is changed. With ramping in use, the initial value of the actual setpoint at power up, or when switching back to automatic mode from manual control, will be equal to the current process variable value. The actual setpoint will rise/fall at the ramp rate set, until it reaches the target setpoint value. Setpoint ramping is used to protect the process from sudden changes in the setpoint, which would result in a rapid rise in the process variable.

Display code = **rP**, default setting = OFF (*blank*).

Also refer to Manual Mode, Setpoint, Setpoint Ramp Enable and Setpoint Select.

Setpoint SelectType: *Controller Parameter*

This Operator Mode parameter is available if the remote setpoint feature is in use and setpoint select is enabled, Setpoint Select defines whether the local or the remote setpoint will be the Active Setpoint. It can be set to **d i**, **LSP**, or **rSP**. If a digital input has been configured for local/remote setpoint selection, the default setting is **d i**. This means the status of the digital input will determine which setpoint is active. Otherwise the user can only choose **LSP**, or **rSP**. The active setpoint is indicated by prefixing its legend with the “**⌘**” character. E.g. the local setpoint legend is **⌘LSP**, when it is active and **LSP** when it is inactive. If a digital input has been configured to select local/remote SP, setting Setpoint Select to **LSP**, or **rSP** will override the digital input and the active SP indication changes to **⌘**.

Display code = **SPS**.

Also refer to Active Setpoint, Remote Setpoint, Setpoint and Setpoint Select Enable.

Setpoint Select EnableType: *Controller Parameter*

If the remote setpoint feature is in use, this determines whether operator selection of setpoints is enabled or disabled. If enabled, the Setpoint Select parameter is available in operator mode. If Setpoint Select is disabled again, the active setpoint will remain at its current status.

Display code = **SSEn**, default setting = **d SA** (disabled).

Also refer to Remote Setpoint and Setpoint.

Solid State Relay (SSR)Type: *General Definition*

An external device manufactured using two silicone controlled rectifiers, which can be used to replace mechanical relays in most AC power applications. As a solid state device, an SSR does not suffer from contact degradation when switching electrical current. Much faster switching cycle times are also possible, leading to superior control. The instrument's SSR Driver output is a time proportioned 10VDC pulse which causes conduction of current to the load when the pulse is on.

Also refer to Cycle Time, Time Proportioning Control, and Triac.

TareType: *Indicator Parameter*

When an Indicator's Tare function has been enabled, the operator can set the current Process Variable input value to be displayed as zero. This function may be used to easily eliminate any offset on the input signal, e.g. when a transducer output is not giving a true zero value. It may also be used in applications displaying the weight of a product, to remove the weight of a container before starting. When Tare is activated, the instrument automatically sets the PV Offset to an equal, but opposite value to the current measured value.

Display code = **tArE**, default setting = **d SA** (disabled).

Also refer to Indicator, Process Variable, and Offset.

Time Proportioning Control

Type: *Controller Definition*

Time proportioning control is accomplished by cycling the output on and off, during the prescribed cycle time, whenever the process variable is within the proportional band. The control algorithm determines the ratio of time (on vs. off) to achieve the level of output power required to correct any error between the process value and setpoint. E.g. for a 32 second cycle time, 25% power would result in the output turning on for 8 seconds, then off to 24 seconds. Time proportioning control can be implemented with Relay, Triac or SSR Driver outputs for either primary (Heat) or secondary (Cool) outputs depending on hardware configuration.

Also refer to Current Proportioning Control, Cycle Time, PID, Primary Proportional Band, Process Variable, Secondary Proportional Band, Setpoint, SSR and Triac.

Tuning

Type: *Controller Definition*

PID Controllers must be tuned to the process in order for them to attain the optimum level of control. Adjustment is made to the tuning terms either manually, or by utilising the controller's automatic tuning facilities. Tuning is not required if the controller is configured for On-Off Control.

Also refer to Automatic Reset, Auto Pre-Tune, On-Off control, PID, Pre-Tune, Primary Proportional Band, Rate, Self-Tune and Secondary Proportional Band.

Triac

Type: *General Definition*

A small internal solid state device, which can be used in place of a mechanical relay in applications switching low power AC, up to 1 amp. Like a relay, the output is time proportioned, but much faster switching cycle times are also possible, leading to superior control. As a solid-state device, a Triac does not suffer from contact degradation when switching electrical currents. A triac cannot be used to switch DC power.

Also refer to Cycle Time, SSR and Time Proportioning Control.

16 Appendix 2 - Specification

Universal Input

General Input Specifications

Input Sample Rate:	Four samples/second.	
Digital Input Filter time constant	0.0 (OFF), 0.5 to 100.0 seconds in 0.5 second increments.	
Input Resolution:	14 bits approximately. Always four times better than display resolution.	
Input Impedance:	10V DC:	47KΩ
	20mA DC:	5Ω
	Other ranges:	Greater than 10MΩ resistive
Isolation:	Isolated from all outputs (except SSR driver). If single relay outputs are connected to a hazardous voltage source, and the universal input is connected to operator accessible circuits, supplementary insulation or input grounding is required.	
PV Offset:	Adjustable ±input span.	
PV Display:	Displays process variable up to 5% over and 5% under span.	

Thermocouple

Thermocouple Ranges Available

Sensor Type	Range Min in °C	Range Max in °C	Range Min in °F	Range Max in °F	Resolution
J (default)	-200	1200	-328	2192	1°
J	-128.8	537.7	-199.9	999.9	0.1°
T	-240	400	-400	752	1°
T	-128.8	400.0	-199.9	752.0	0.1°
K	-240	1373	-400	2503	1°
K	-128.8	537.7	-199.9	999.9	0.1°
L	0	762	32	1403	1°
L	0.0	537.7	32.0	999.9	0.1°
N	0	1399	32	2551	1°
B	100	1824	211	3315	1°
R	0	1759	32	3198	1°
S	0	1762	32	3204	1°
C	0	2320	32	4208	1°
PtRh20%: PtRh40%	0	1850	32	3362	1°

Note:

Defaults to °F for USA units. Defaults to °C for non-USA units.

The Configuration Mode parameters, Scale Range Upper Limit and Scale Range Lower Limit, can be used to restrict range.

Thermocouple Performance

Calibration:	Complies with BS4937, NBS125 and IEC584.
Measurement Accuracy:	±0.1% of full range span ±1LSD. NOTE: Reduced performance for B Thermocouple from 100 to 600°C. NOTE: PtRh 20% vs PtRh 40% Thermocouple accuracy is 0.25% and has reduced performance below 800°C.
Linearisation Accuracy:	Better than ±0.2°C any point, for 0.1° resolution ranges (±0.05°C typical). Better than ±0.5°C any point, for 1° resolution ranges.
Cold Junction Compensation:	Better than ±0.7°C under reference conditions. Better than ±1°C under operating conditions.
Temperature Stability:	0.01% of span/°C change in ambient temperature.
Supply Voltage Influence:	Negligible.
Relative Humidity Influence:	Negligible.
Sensor Resistance Influence:	Thermocouple 100Ω: <0.1% of span error. Thermocouple 1000Ω: <0.5% of span error.
Sensor Break Protection:	Break detect approx two seconds. Control outputs turn OFF (0% power); Limit outputs turn off (goes into Exceed condition); Alarms operate as if the process variable is over-range.

Resistance Temperature Detector (RTD)

RTD Ranges Available

Range Min in °C	Range Max in °C	Range Min in °F	Range Max in °F	Resolution
-128.8	537.7	-199.9	999.9	0.1°
-199	800	-328	1472	1° (default)

Note:

Scale Range Upper Limit and Scale Range Lower Limit Configuration Mode parameters can be used to restrict range.

RTD Performance

Type:	Three-wire Pt100.
Calibration:	Complies with BS1904 and DIN43760 (0.00385Ω/Ω/°C).
Measurement Accuracy:	±0.1% of span ±1LSD.
Linearisation Accuracy:	Better than ±0.2°C any point, any 0.1°C range (±0.05°C typical). Better than ±0.5°C any point, any 1°C range.
Temperature Stability:	0.01% of span/°C change in ambient temperature.
Supply Voltage Influence:	Negligible.
Relative Humidity Influence:	Negligible.
Sensor Resistance Influence:	Pt100 50Ω/lead: <0.5% of span error.
Lead Compensation:	Automatic scheme.
RTD Sensor Current:	150µA (approximately).
Sensor Break Protection:	Break detect approx two seconds. Control outputs turn OFF (0% power); Limit outputs turn off (goes into Exceed condition); Alarms operate as if the process variable has gone over-range.

DC Linear

DC Linear Ranges Available

0 to 20mA	0 to 50mV	0 to 5V
4 to 20mA (default)	10 to 50mV	1 to 5V
		0 to 10V
		2 to 10V

DC Linear Performance

Scale Range Upper Limit:	-1999 to 9999. Decimal point as required.
Scale Range Lower Limit:	-1999 to 9999. Decimal point as for Scale Range Upper Limit.
Minimum Span:	1 display LSD.
Measurement Accuracy:	±0.1% of span ±1LSD.
Temperature stability:	0.01% of span/°C change in ambient temperature.
Supply Voltage Influence:	Negligible.
Relative Humidity Influence:	Negligible.
Input Protection:	Up to 10 times maximum span of selected input connection.
Sensor Break Protection:	Applicable for 4 to 20mA, 1 to 5V and 2 to 10V ranges only. Break detect approx two seconds. Control outputs turn OFF (0% power); Limit outputs turn off (goes into Exceed condition); Alarms operate as if process variable is under-range.

Remote Setpoint Input

Input Sampling rate:	4 per second
Input Resolution:	13 bits minimum
Input types:	4 to 20mA, 0 to 20mA, 0 to 10V, 2 to 10V, 0 to 5V, 1 to 5V. The Full RSP in Option Slot B also supports 0 to 100mv and Potentiometer (2KΩ or higher).
Measurement Accuracy (reference conditions):	±0.25% of input span ±1 LSD
Input resistance:	Voltage ranges: 47KΩ nominal Current ranges: 5Ω
Input protection:	Voltage input: will withstand up to 5x input voltage overload without damage or degradation of performance in either polarity. Current input: will withstand 5x input current overload in reverse direction and up to 1A in the normal direction.
Isolation:	Slot A has basic isolation from other inputs and outputs. Slot B has reinforced isolation from other inputs and outputs.
Sensor Break Detection:	For 4 to 20mA, 2 to 10V and 1 to 5V ranges only.

Digital Inputs

Type:	Voltage-free or TTL-compatible
Voltage-Free Operation: <i>functions depend on model and how configured</i>	Connection to contacts of external switch or relay: Open = SP1, Automatic Mode or Local setpoint selected. <i>Minimum contact resistance = 5KΩ,</i> Closed = SP2, Manual Mode, Remote Setpoint selected, Latching Relay, Stored Min/Max/Time reset (edge triggered) or Tare activate (edge triggered). <i>Maximum contact resistance = 50Ω.</i>
TTL levels: <i>functions depend on model and how configured</i>	2.0 to 24VDC = SP1, Automatic Mode, Local Setpoint selected. -0.6 to 0.8VDC = SP2, Manual Mode, Remote Setpoint selected, Latching Relay, Stored Min/Max/Time reset (edge triggered) or Tare activate (edge triggered).
Maximum Input Delay (OFF-ON):	0.25 second.
Maximum Input Delay (ON-OFF):	0.25 second.
Isolation:	Reinforced safety isolation from any source of hazardous voltages.

Output Specifications

Output Module Types

Option Slot 1 Module Options:	Relay, SSR drive, Triac or DC linear. <i>Limit Controllers have a fixed Latching Relay only.</i>
Option Slot 2 Module Options:	Relay, Dual Relay, SSR drive, Triac or DC linear.
Option Slot 3 Module Options:	Relay, SSR drive, DC Linear or Transmitter PSU. <i>1/8 DIN Indicators also support the Dual Relay option.</i>

Specifications of Output Types

Single Relay:	Contact Type:	Single pole double throw (SPDT).
	Control Rating:	2A resistive at 120/240V AC Limit Controller output 1 has fixed 5A latching relay.
	Alarm, Event or EOP Rating:	2A resistive at 120/240V AC
	Control/Alarm Lifetime:	>500,000 operations at rated voltage/current.
	Limit Output Lifetime:	>100,000 operations at rated voltage/current.
	Isolation:	Basic Isolation from universal input and SSR outputs.
Dual Relay:	Contact Type:	2 x Single pole single throw (SPST) with shared common.
	Control Rating:	2A resistive at 120/240V AC
	Control/Alarm Lifetime:	>200,000 operations at rated voltage/current.
	Isolation:	Reinforced safety isolation from inputs and other outputs.
SSR Driver:	Drive Capability:	10V minimum at up to 20mA load.
	Isolation:	Not isolated from universal input or other SSR driver outputs.
Triac:	Operating Voltage Range:	20 to 280Vrms (47 to 63Hz).
	Current Rating:	0.01 to 1A (full cycle rms on-state @ 25°C); derates linearly above 40°C to 0.5A @ 80°C.
	Max. Non-repetitive Surge Current (16.6ms):	25A peak.
	Min. OFF-State dv/dt @ Rated Voltage:	500V/μs.
	Max. OFF-State leakage @ Rated Voltage:	1mA rms.
	Max. ON-State Voltage Drop @ Rated Current:	1.5V peak.
	Repetitive Peak OFF-state Voltage, Vdrm:	600V minimum.
	Isolation:	Reinforced safety isolation from inputs and other outputs.

Linear DC:	Resolution:	Eight bits in 250mS (10 bits in 1 second typical, >10 bits in >1 second typical).
	Update Rate:	Every control algorithm execution.
	Ranges:	0 to 10V 0 to 20mA 0 to 5V 4 to 20mA 2 to 10V (default)
	Load Impedance:	0 to 20mA & 4 to 20mA: 500Ω maximum. 0 to 5V, 0 to 10V & 2 to 10V: 500Ω minimum. Short circuit protected.
	Accuracy:	±0.25% (mA @ 250Ω, V @ 2kΩ). Degrades linearly to ±0.5% for increasing burden (to specification limits).
	When used as control output:	For 4 to 20mA and 2 to 10V a 2% over/underdrive is applied (3.68 to 20.32mA and 1.84 to 10.16V).
	Isolation:	Reinforced safety isolation from inputs and other outputs.
	Use as 0 to 10VDC transmitter power supply*	Adjustable, 0.0 to 10.0V (regulated) output into 500Ω minimum.
Transmitter Power Supply: <i>*see Linear output spec for 0-10V PSU</i>	Power Rating	20 to 28VDC (24V nominal) into 910Ω minimum resistance.
	Isolation:	Reinforced safety isolation from inputs and other outputs.

Control Specifications

Automatic Tuning Types:	Pre-Tune, Self-Tune.
Proportional Bands:	0 (OFF), 0.5% to 999.9% of input span at 0.1% increments.
Automatic Reset (Integral Time Constant):	1s to 99min 59s and OFF.
Rate (Derivative Time Constant):	0 (OFF) to 99 min 59 s.
Manual Reset (Bias):	Added each control algorithm execution. Adjustable in the range 0 to 100% of output power (single output) or -100% to +100% of output power (dual output).
Deadband/Overlap:	-20% to +20% of Proportional Band 1 + Proportional Band 2.
ON/OFF Differential:	0.1% to 10.0% of input span.
Auto/Manual Control:	User-selectable with “bumpless” transfer into and out of Manual Control.
Cycle Times:	Selectable from 0.5s to 512 seconds in binary steps.
Setpoint Range:	Limited by Setpoint Upper Limit and Setpoint Lower Limit.
Setpoint Maximum:	Limited by Setpoint and Scale Range Upper Limit.
Setpoint Minimum:	Limited by Scale Range Lower Limit and Setpoint.
Setpoint Ramp:	Ramp rate selectable 1 to 9999 LSD's per hour and infinite. Number displayed is decimal-point-aligned with display.

Process Alarms

Maximum Number of Alarms (Controllers):	Two “soft” process alarms (high, low, deviation or band) plus Loop Alarm.
Maximum Number of Alarms (Indicators):	Five “soft” alarms (process high or low)
Combinatorial Alarms:	Logical OR or AND of alarms to any suitable output.

Digital Communications

Type:	Asynchronous Serial.
Protocols:	ASCII and Modbus RTU.
Physical Layer:	RS485.
Zone address range:	1 to 99 (ASCII), 1 to 255 (Modbus).
Bit rate:	1200, 2400, 4800, 9600 and 19200 bps.
Bits per character:	ASCII: 10 Modbus: 10 or 11 (depending on parity setting)
Stop bits:	1
Parity:	ASCII: Even (fixed). Modbus: None, even or odd (selectable).
Isolation:	Reinforced safety isolation from inputs and outputs.

Reference Conditions

Ambient Temperature:	20°C ±2°C.
Relative Humidity:	60 to 70%.
Supply Voltage:	100 to 240V AC 50Hz ±1%.
Source Resistance:	<10Ω for thermocouple input.
Lead Resistance:	<0.1Ω/lead balanced (Pt100).

Operating Conditions

Ambient Temperature (operating):	0°C to 55°C.
Ambient Temperature (storage):	-20°C to 80°C.
Relative Humidity:	20% to 95% non-condensing.
Altitude:	Up to 2000m above sea level.
Supply Voltage:	Either 100 to 240V ±10% AC 50/60Hz or 20 to 48V AC 50/60Hz & 22 to 55V DC
Power Consumption:	5W / 7.5 VA maximum.
Source Resistance:	1000Ω maximum (thermocouple).
PT100 Input Lead Resistance:	50Ω per lead maximum, balanced

Standards

Conformance Norms:	CE, UL, ULC.
EMC standards:	EN61326*
Safety Standards:	EN61010 and UL3121. Pollution Degree 2, Installation Category II. Also FM 3545, 1998 for Limit Controllers.
Front Panel Sealing:	IP66

Note:

**For disturbances induced by RF fields of 10V/m 80% AM at 1kHz the input accuracy specification is changed to 0.25% in the frequency bands 465 to 575 MHz and 630 to 660 MHz.*

Physical Specifications

Dimensions:	Depth behind panel:	110mm (1/16 DIN instruments). 100mm (1/8 DIN instruments).
	Front bezel size (w x h):	48 x 48mm (1/16 DIN controllers). 48 x 96mm (1/8 DIN controllers). 96 x 48mm (1/8 DIN indicators).
Mounting:		Plug-in with panel mounting fixing strap.
Panel cut-out size (w x h)::		45mm x 45mm (1/16 DIN controllers). 45 x 92mm (1/8 DIN controllers). 92 x 45mm (1/8 DIN indicators).
Terminals:		Screw type (combination head).
Weight:		0.21kg maximum.

17 Appendix 3 - Product Coding

Model Code	xxxxxx	-	x	-	x	-	x	-	x	-	x	-	x	-	x	-	x
Model Type																	
1/16 - DIN Controller	UDC120																
1/8 - DIN Controller	UDC170																
1/8 - DIN Indicator	UDI170																
Input Type																	
3 Wire RTD or DC mV			1														
Thermocouple			2														
DC mA			3														
DC Voltage			4														
Universal Input + Full RSP	(DC170)		R														
Limit Controller	(DC120)		L														
Option Slot 1																	
Relay Output			1														
DC Drive Output for SSR	(Not DC120L)		2														
Linear 0-10V DC Output	(Not DC120L)		3														
Linear 0-20mA DC Output	(Not DC120L)		4														
Linear 0-5V DC Output	(Not DC120L)		5														
Linear 2-10V DC Output	(Not DC120L)		6														
Linear 4-20mA DC Output	(Not DC120L)		7														
Triac Output	(Not DC120L)		8														
Option Slot 2																	
Not fitted			0														
Relay Output			1														
DC Drive Output for SSR			2														
Linear 0-10V DC Output			3														
Linear 0-20mA DC Output			4														
Linear 0-5V DC Output			5														
Linear 2-10V DC Output			6														
Linear 4-20mA DC Output			7														
Triac Output			8														
Dual Relay Output	(DI1700)		9														

Continued on next page

Model Code	xxxxxx	-	x	-	x	-	x	-	x	-	x	-	x	-	x
Option Slot 3															
Not fitted	0														
Relay Output	1														
DC Drive Output for SSR	2														
Linear 0-10V DC Output	3														
Linear 0-20mA DC Output	4														
Linear 0-5V DC Output	5														
Linear 2-10V DC Output	6														
Linear 4-20mA DC Output	7														
Transmitter Power Supply	8														
Dual Relay Output (DI1700)	9														
Option Slot A															
Not fitted	0														
RS-485 Serial Communications	1														
Digital Input 1	2														
Basic Remote Setpoint Input (Not DC120L or DI1700)	4														
Supply Voltage															
100-240V AC	0														
24-48V AV or DC	2														
Manual Language															
No Manual	0														
English	1														
French	2														
German	3														
Italian	4														
Spanish	5														
English/French/German/Italian/Spanish - Concise Manuals only	9														
Packing Options															
Single Pack with Concise Manual	0														
Bulk Pack with 1 Concise Manual per unit - (Minimum 20 pieces)	1														
Bulk Pack No Manual - (Minimum 20 pieces)	2														
Bulk Pack with 1 Full Manual per unit - (Minimum 20 pieces)	3														
Single Pack with 1 Full Manual per unit	5														

Note:

Not all of the above code combinations are possible with every model.

Honeywell contacts

ARGENTINA

HONEYWELL S.A.I.C.
BELGRANO 1156
BUENOS AIRES
ARGENTINA
Tel. : 54 1 383 9290

ASIA PACIFIC

HONEYWELL ASIA
PACIFIC Inc.
Room 3213-3225
Sun Kung Kai Centre
N° 30 Harbour Road
WANCHAI
HONG KONG
Tel. : 852 829 82 98

AUSTRALIA

HONEYWELL LIMITED
5 Thomas Holt Drive
North Ryde Sydney
NSW AUSTRALIA 2113
Tel. : 61 2 353 7000
AUSTRIA

HONEYWELL AUSTRIA

G.m.b.H.
Handelskai 388
A1020 VIENNA
AUSTRIA
Tel. : 43 1 727 800

BELGIUM

HONEYWELL S.A.
3 Avenue de Bourget
B-1140 BRUSSELS
BELGIUM
Tel. : 32 2 728 27 11

BRAZIL

HONEYWELL DO
BRAZIL
AND CIA
Rua Jose Alves Da
Chunha
Lima 172
BUTANTA
05360.050 SAO PAULO
SP
BRAZIL
Tel. : 55 11 819 3755

BULGARIA

HONEYWELL EOOD
14, Iskarsko Chausse
POB 79
BG- 1592 Sofia
BULGARIA
Tel : 359-791512/
794027/ 792198

CANADA

HONEYWELL LIMITED
THE HONEYWELL
CENTRE
300 Yorkland Blvd.
NORTH YORK,
ONTARIO
M2J 1S1
CANADA
Tel.: 800 461 0013
Fax.: 416 502 5001

CZECH

REPUBLIC
HONEYWELL, Spol.s.r.o.
Budejovicka 1
140 21 Prague 4
Czech Republic
Tel. : 42 2 6112 3434

DENMARK

HONEYWELL A/S
Automatikvej 1
DK 2860 Soeborg
DENMARK
Tel. : 45 39 55 56 58

FINLAND

HONEYWELL OY
Ruukintie 8
FIN-02320 ESPOO 32
FINLAND
Tel. : 358 0 3480101

FRANCE

HONEYWELL S.A.
Bâtiment « le Mercury »
Parc Technologique de St
Aubin
Route de l'Orme
(CD 128)
91190 SAINT-AUBIN
FRANCE
Tel. from France:
01 60 19 80 00
From other countries:
33 1 60 19 80 00

GERMANY

HONEYWELL AG
Kaiserleistrasse 39
D-63067 OFFENBACH
GERMANY
Tel. : 49 69 80 64444

HUNGARY

HONEYWELL Kft
Gogol u 13
H-1133 BUDAPEST
HUNGARY
Tel. : 36 1 451 43 00

ICELAND

HONEYWELL
Hataekni .hf
Armuli 26
PO Box 8336
128 reykjavik
Iceland
Tel : 354 588 5000

ITALY

HONEYWELL S.p.A.
Via P. Gobetti, 2/b
20063 Cernusco Sul
Naviglio
ITALY
Tel. : 39 02 92146 1

MEXICO

HONEYWELL S.A. DE
CV
AV. CONSTITUYENTES
900
COL. LOMAS ALTAS
11950 MEXICO CITY
MEXICO
Tel : 52 5 259 1966

THE NETHERLANDS

HONEYWELL BV
Laaderhoogweg 18
1101 EA AMSTERDAM
ZO
THE NETHERLANDS
Tel : 31 20 56 56 911

NORWAY

HONEYWELL A/S
Askerveien 61
PO Box 263
N-1371 ASKER
NORWAY
Tel. : 47 66 76 20 00

POLAND

HONEYWELL Sp.z.o.o
Ul Domainewksa 41
02-672 WARSAW
POLAND
Tel. : 48 22 606 09 00

PORTUGAL

HONEYWELL
PORTUGAL LDA
Edificio Suecia II
Av. do Forte nr 3 - Piso 3
2795 CARNAXIDE
PORTUGAL
Tel. : 351 1 424 50 00

REPUBLIC OF IRELAND

HONEYWELL
Unit 1
Robinhood Business
Park
Robinhood Road
DUBLIN 22
Republic of Ireland
Tel. : 353 1 4565944

REPUBLIC OF SINGAPORE

HONEYWELL PTE LTD
BLOCK 750E CHAI
CHEE ROAD
06-01 CHAI CHEE IND.
PARK
1646 SINGAPORE
REP. OF SINGAPORE
Tel. : 65 2490 100

REPUBLIC OF SOUTH AFRICA

HONEYWELL
Southern Africa
PO BOX 138
Milnerton 7435
REPUBLIC OF SOUTH
AFRICA
Tel. : 27 11 805 12 01

ROMANIA

HONEYWELL Office
Bucharest
147 Aurel Vlaicu Str.,
Sc.Z.,
Apt 61/62
R-72921 Bucharest
ROMANIA
Tel : 40-1 211 00 76/
211 79

RUSSIA

HONEYWELL INC
4 th Floor Administrative
Builiding of AO "Luzhniki"
Management
24 Luzhniki
119048 Moscow
RUSSIA
Tel : 7 095 796 98 00/01

SLOVAKIA

HONEYWELL Ltd
Mlynske nivy 73
PO Box 75
820 07 BRATISLAVA 27
SLOVAKIA
Tel. : 421 7 52 47 400/
425

SPAIN

HONEYWELL S.A
Factory
Josefa Valcarcel, 24
28027 MADRID
SPAIN
Tel. : 34 91 31 3 61 00

SWEDEN

HONEYWELL A.B.
S-127 86 Skarholmen
STOCKHOLM
SWEDEN
Tel. : 46 8 775 55 00

SWITZERLAND

HONEYWELL A.G.
Hertistrasse 2
8304 WALLISELLEN
SWITZERLAND
Tel. : 41 1 831 02 71

TURKEY

HONEYWELL
Otomasyon ve Kontrol
Sistemlen San ve Tic
A.S.
(Honeywell Turkey A.S.)
Emirhan Cad No 144
Barbaros Plaza C. Blok
Kat 18
Dikilitas 80700 Istanbul
TURKEY
Tel : 90-212 258 18 30

UNITED KINGDOM

HONEYWELL
Unit 1,2 &4 Zodiac House
Calleva Park
Aldermaston
Berkshire RG7 8HW
UNITED KINGDOM
Tel : 44 118 906 2600

U.S.A.

HONEYWELL INC.
INDUSTRIAL PROCESS
CONTROLS
1100 VIRGINIA DRIVE
PA 19034-3260
FT. WASHINGTON
U.S.A.
Tel. : 1-800-343-0228

VENEZUELA

HONEYWELL CA
APARTADO 61314
1060 CARACAS
VENEZUELA
Tel. : 58 2 239 0211

