

- ❖ All DC type with 「Short-circuit」 & 「Polarity reversed」 protection.
直流型都附「短路保護」及「極性保護」回路
- ❖ All AC type with 「surge absorbing circuit」 to avoid surge damage.
交流型都附「突波吸收回路」可有效防止突波破壞
- ❖ High solid compact structure 「IP-67」 suited to applied in any poor circumstance.
堅固結構「IP-67」適用各種惡劣環境
- ❖ All models with 「operating pilot.」
全機種都附「動作指示燈」



◆ Guiding of model / 型號索引

Tubular type

Ex. PM 12-04 NBS-M12
1 2 3 4 5 6 7

- 1> Type / 型式
PM = Screw type / 螺絲型
PT = Tubular type / 圓管型
- 2> Outline diameter / 外徑
05 = M5 x 1.0 08 = M8 x 1.0 12 = M12 x 1.0
18 = M18 x 1.0 30 = M30 x 1.5
- 3> Sensing distance / 感應距離
01 = 1.0 mm 02 = 2.0 mm 04 = 4.0 mm
05 = 5.0 mm 08 = 8.0 mm 10 = 10.0 mm
15 = 15.0 mm 20 = 20.0 mm 25 = 25.0 mm
- 4> Output method / 輸出方式
N = NPN P = PNP S = SCR
- 5> Output status / 輸出狀態
Non = NO type B = NC type
- 6> Length or shape or material of body / 本體
Non = Cu plated Ni / 銅鍍鎳
S = Short type / 短型
E = Body with all screw / 全牙型
K = Stainless steel / 白鐵
- 7> Connection method / 接線方式
Non = Lead wire type / 出線式
PG = M8 lead wire type / M8 接頭出線式
M12 = M12 connector type / M12 接頭式

Square type

Ex. LS - 04 NB-V-PG
1 2 3 4 5 6

- 1> Type / 型式
SP = Plate type / 扁型
LS = Long square type / 長條型
BS = Micro switch type / 微動開關型
PS = Square type / 方型
PL = Long square type / 長方型
PP = Plate type / 扁型
- 2> Sensing distance / 感應距離
02 = 2.0 mm 04 = 4.0 mm
05 = 5.0 mm 08 = 8.0 mm
10 = 10.0 mm 15 = 15.0 mm
25 = 25.0 mm
- 3> Output method / 輸出方式
N = NPN P = PNP S = SCR
- 4> Output status / 輸出狀態
Non = NO type B = NC type
- 5> Sensing direction / 檢測方向
Non = Horizontal type / 水平式
V = Vertical type / 垂直式
- 6> Connection method / 接線方式
Non = Lead wire type / 出線式
PG = M8 lead wire type / M8 接頭出線式
M12 = M12 connector type / M12 接頭式

◆ Output circuit & connection diagram / 輸出回路及接線圖

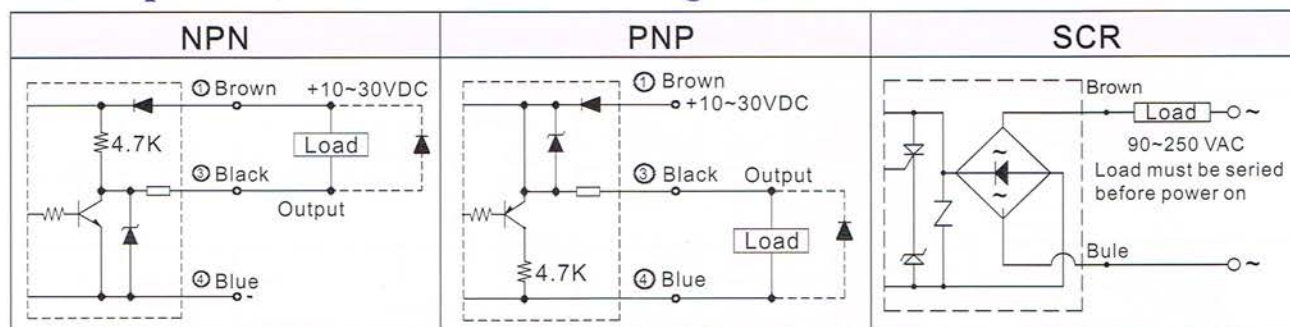

◆ General data / 共同規格

| Specification | | DC type | AC type |
|-----------------------|-------|-------------------------------------|-------------------------|
| Operating voltage | 工作電壓 | 10 ~ 30 VDC | 90 ~ 250 VAC |
| Power ripple | 電源漣波 | <20% of Vp-p | 50/60Hz |
| Output current | 輸出電流 | 150 mA max. | 100mA max. |
| Current consumption | 消耗電流 | 10 mA max. | 2.0mA max. |
| Residual voltage | 殘留電壓 | < 0.1V | <15V |
| Leakage current | 洩漏電流 | <0.8 mA | <4.0 mA |
| Hysteresis | 應差 | <10% of sensing distance | |
| Thermal drift | 溫度漂移 | <10 μ m/ $^{\circ}$ C | |
| Voltage drift | 電壓漂移 | <1 μ m/V | |
| Protection circuit | 保護回路 | Short-circuit & Polarity reversed | surge absorbing circuit |
| Operating Temperature | 工作溫度 | -25 $^{\circ}$ C ~ +80 $^{\circ}$ C | |
| Operating humidity | 工作濕度 | 35% ~ 95% RH | |
| Protection class | 保護等級 | IP-67 | |
| Color of sensing face | 感應面顏色 | NPN=Red ; PNP=Green | Blue |

◆ Application hints

While a switching power supply is used, please be sure to ground the FG (Frame ground) and the G (Ground) terminal, if failure to do so, it may resulting malfunction of the sensor for the noise of the switching power supply. Meanwhile, the ripple of the DC power supply is required less than 20% to avoid resulting malfunction of the sensor.

◆ M8 lead wire connection [Available for all sensor]

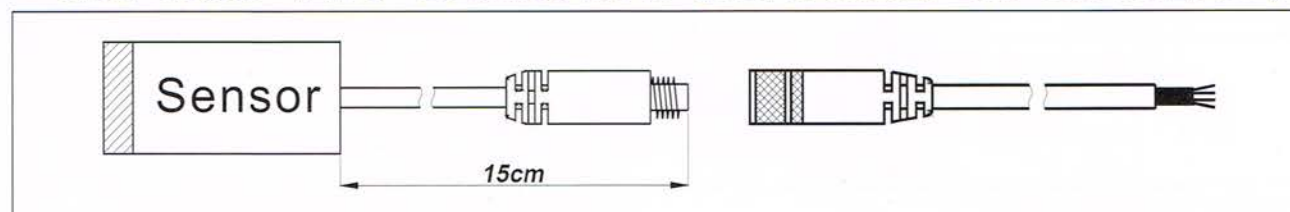

◆ **PT04 / M5 / M8 Tubular type**

| Outline | Model | Output status | Output method | Sensing distance | Mounting method | Response frequency | Operating voltage | Housing material |
|---------|-------------|---------------|---------------|------------------|-----------------|--------------------|-------------------|------------------|
| | PT04-01N | NO | NPN | 0.8 mm | Flushed | 2.5KHz | 10~30 VDC | SUS 304 |
| | | NO | | | | | | |
| | PT04-01P | NO | PNP | | | | | |
| | | NO | | | | | | |
| | PT04-02N | NO | NPN | 1.5 mm | | | | |
| | | NO | | | | | | |
| | PT04-02P | NO | PNP | | | | | |
| | | NO | | | | | | |
| | PM05-01N | NO | NPN | 0.8 mm | Flushed | 2.5KHz | 10~30 VDC | SUS 304 |
| | PM05-01NB | NC | | | | | | |
| | PM05-01P | NO | | | | | | |
| | PM05-01PB | NC | | | | | | |
| | PM05-02N | NO | NPN | 1.5 mm | Non-flushed | 2.5KHz | 10~30 VDC | SUS 304 |
| | PM05-02NB | NC | | | | | | |
| | PM05-02P | NO | | | | | | |
| | PM05-02PB | NC | | | | | | |
| | PM08-01N | NO | NPN | 1.0 mm | Flushed | 2.5KHz | 10~30 VDC | Cu plated Ni |
| | PM08-01NB | NC | | | | | | |
| | PM08-01P | NO | | | | | | |
| | PM08-01PB | NC | | | | | | |
| | PM08-02N | NO | NPN | 2.0 mm | Non-flushed | 2.5KHz | 10~30 VDC | Cu plated Ni |
| | PM08-02NB | NC | | | | | | |
| | PM08-02P | NO | | | | | | |
| | PM08-02PB | NC | | | | | | |
| | PM08-01NS | NO | NPN | 1.0 mm | Flushed | 2.5KHz | 10~30 VDC | SUS 304 |
| | PM08-01NSB | NC | | | | | | |
| | PM08-01PS | NO | | | | | | |
| | PM08-01PSB | NC | | | | | | |
| | PM08-02NS | NO | NPN | 2.0 mm | Non-flushed | 2.5KHz | 10~30 VDC | SUS 304 |
| | PM08-02NSB | NC | | | | | | |
| | PM08-02PS | NO | | | | | | |
| | PM08-02PSB | NC | | | | | | |
| | PM08-01N-P | NO | NPN | 1.0 mm | Flushed | 2.5KHz | 10~30 VDC | PP |
| | PM08-01NB-P | NO | | | | | | |
| | PM08-01P-P | NO | | | | | | |
| | PM08-01PB-P | NO | | | | | | |
| | PM08-02N-P | NO | NPN | 2.0 mm | Non-flushed | 2.5KHz | 10~30 VDC | PP |
| | PM08-02NB-P | NO | | | | | | |
| | PM08-02P-P | NO | | | | | | |
| | PM08-02PB-P | NO | | | | | | |
| | PM08-01N-K | NO | NPN | 1.0 mm | Flushed | 2.5KHz | 10~30 VDC | SUS 304 |
| | PM08-01NB-K | NC | | | | | | |
| | PM08-01P-K | NO | | | | | | |
| | PM08-01PB-K | NC | | | | | | |
| | PM08-02N-K | NO | NPN | 2.0 mm | Non-flushed | 2.5KHz | 10~30 VDC | SUS 304 |
| | PM08-02NB-K | NC | | | | | | |
| | PM08-02P-K | NO | | | | | | |
| | PM08-02PB-K | NC | | | | | | |



◆ M12 Tubular type

| Outline | Model | Output status | Output method | Sensing distance | Mounting method | Response frequency | Operating voltage | Housing material |
|-------------|---------------|---------------|---------------|------------------|-----------------|--------------------|-------------------|------------------|
| | PM12-02N | NO | NPN | 2.0 mm | Flushed | 2.5KHz | 10~30 VDC | Cu plated Ni |
| | PM12-02NB | NC | | | | | | |
| | PM12-02P | NO | PNP | | | | | |
| | PM12-02PB | NC | | | | | | |
| | PM12-02S | NO | SCR | | | | | |
| PM12-02SB | NC | | | | | | | |
| | PM12-04N | NO | NPN | 4.0 mm | Non-flushed | 2.5KHz | 10~30 VDC | Cu plated Ni |
| | PM12-04NB | NC | | | | | | |
| | PM12-04P | NO | PNP | | | | | |
| | PM12-04PB | NC | | | | | | |
| | PM12-04S | NO | SCR | | | | | |
| PM12-04SB | NC | | | | | | | |
| | PM12-02NS | NO | NPN | 2.0 mm | Flushed | 2.5KHz | 10~30 VDC | Cu plated Ni |
| | PM12-02NBS | NC | | | | | | |
| | PM12-02PS | NO | PNP | | | | | |
| | PM12-02PBS | NC | | | | | | |
| | PM12-04NS | NO | NPN | 4.0 mm | Non-flushed | 2.5KHz | 10~30 VDC | Cu plated Ni |
| | PM12-04NBS | NC | | | | | | |
| | PM12-04PS | NO | PNP | | | | | |
| | PM12-04PBS | NC | | | | | | |
| | PM12-04N-P | NO | NPN | 4.0 mm | Non-flushed | 2.5KHz | 10~30 VDC | PBT |
| | PM12-04NB-P | NC | | | | | | |
| | PM12-04P-P | NO | PNP | | | | | |
| | PM12-04PB-P | NC | | | | | | |
| | PM12-04S-P | NO | SCR | | | | | |
| PM12-04SB-P | NC | | | | | | | |
| | PM12-02N-E | NO | NPN | 2.0 mm | Flushed | 2.5KHz | 10~30 VDC | Cu plated Ni |
| | PM12-02NB-E | NC | | | | | | |
| | PM12-02P-E | NO | PNP | | | | | |
| | PM12-02PB-E | NC | | | | | | |
| | PM12-04N-E | NO | NPN | 4.0 mm | Non-flushed | 2.5KHz | 10~30 VDC | Cu plated Ni |
| | PM12-04NB-E | NC | | | | | | |
| | PM12-04P-E | NO | PNP | | | | | |
| | PM12-04PB-E | NC | | | | | | |
| | PM12-02N-M12 | NO | NPN | 2.0 mm | Flushed | 2.5KHz | 10~30 VDC | Cu plated Ni |
| | PM12-02NB-M12 | NC | | | | | | |
| | PM12-02P-M12 | NO | PNP | | | | | |
| | PM12-02PB-M12 | NC | | | | | | |
| | PM12-04N-M12 | NO | NPN | 4.0 mm | Non-flushed | 2.5KHz | 10~30 VDC | Cu plated Ni |
| | PM12-04NB-M12 | NC | | | | | | |
| | PM12-04P-M12 | NO | PNP | | | | | |
| | PM12-04PB-M12 | NC | | | | | | |

◆ **M18 Tubular type**

| Outline | Model | Output status | Output method | Sensing distance | Mounting method | Response frequency | Operating voltage | Housing material | | | | |
|---------|---------------|---------------|---------------|------------------|-----------------|--------------------|-------------------|------------------|--------|-------------|------|------------|
| | PM18-05NS | NO | NPN | 5.0 mm | Flushed | 800Hz | 10~30 VDC | Cu plated Ni | | | | |
| | PM18-05NBS | NC | | | | | | | | | | |
| | PM18-05PS | NO | PNP | | | | | | | | | |
| | PM18-05PBS | NC | | | | | | | | | | |
| | PM18-08NS | NO | NPN | 8.0 mm | Non-flushed | 800Hz | 10~30 VDC | Cu plated Ni | | | | |
| | PM18-08NBS | NC | | | | | | | | | | |
| | PM18-08PS | NO | PNP | | | | | | | | | |
| | PM18-08PBS | NC | | | | | | | | | | |
| | PM18-05N | NO | NPN | 5.0 mm | Flushed | 800Hz | 10~30 VDC | Cu plated Ni | | | | |
| | PM18-05NB | NC | | | | | | | | | | |
| | PM18-05P | NO | PNP | | | | | | | | | |
| | PM18-05PB | NC | | | | | | | | | | |
| | PM18-05S | NO | SRC | | | | | | 5.0 mm | Flushed | 20Hz | 90~250 VAC |
| | PM18-05SB | NC | | | | | | | | | | |
| | PM18-08N | NO | NPN | 8.0 mm | Non-flushed | 800Hz | 10~30 VDC | Cu plated Ni | | | | |
| | PM18-08NB | NC | | | | | | | | | | |
| | PM18-08P | NO | PNP | | | | | | | | | |
| | PM18-08PB | NC | | | | | | | | | | |
| | PM18-08S | NO | SRC | | | | | | 8.0 mm | Non-flushed | 20Hz | 90~250 VAC |
| | PM18-08SB | NC | | | | | | | | | | |
| | PM18-08N-P | NO | NPN | 8.0 mm | Non-flushed | 800Hz | 10~30 VDC | PP | | | | |
| | PM18-08NB-P | NC | | | | | | | | | | |
| | PM18-08P-P | NO | PNP | | | | | | | | | |
| | PM18-08PB-P | NC | | | | | | | | | | |
| | PM18-08S-P | NO | SRC | | | | | | 8.0 mm | Non-flushed | 20Hz | 90~250 VAC |
| | PM18-08SB-P | NC | | | | | | | | | | |
| | PM18-05N-M12 | NO | NPN | 5.0 mm | Flushed | 800Hz | 10~30 VDC | Cu plated Ni | | | | |
| | PM18-05NB-M12 | NC | | | | | | | | | | |
| | PM18-05P-M12 | NO | PNP | | | | | | | | | |
| | PM18-05PB-M12 | NC | | | | | | | | | | |
| | PM18-08N-M12 | NO | NPN | 8.0 mm | Non-flushed | 800Hz | 10~30 VDC | Cu plated Ni | | | | |
| | PM18-08NB-M12 | NC | | | | | | | | | | |
| | PM18-08P-M12 | NO | PNP | | | | | | | | | |
| | PM18-08PB-M12 | NC | | | | | | | | | | |

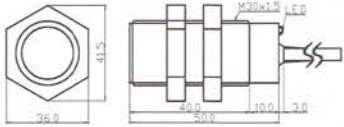
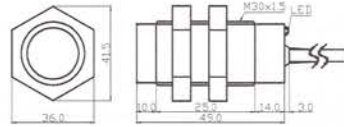
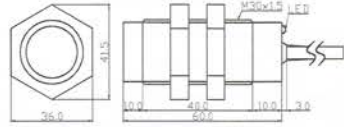
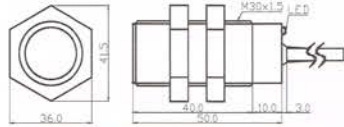
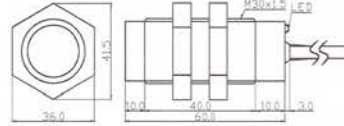
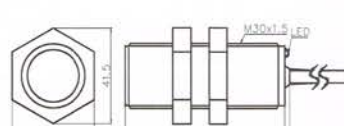
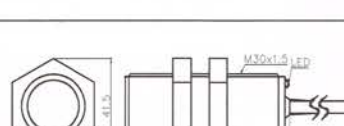
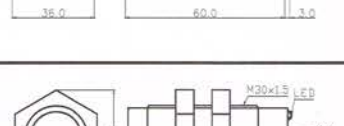
◆ M30 Tubular type

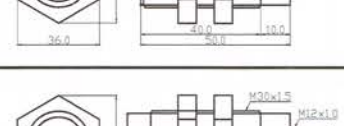
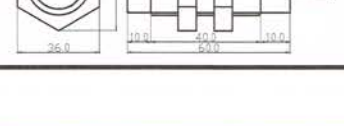
| Outline | Model | Output status | Output method | Sensing distance | Mounting method | Response frequency | Operating voltage | Housing material |
|---|---------------|---------------|---------------|------------------|-----------------|--------------------|-------------------|------------------|
|  | PM30-10N | NO | NPN | 10.0 mm | Flushed | 500Hz | 10~30 VDC | Cu plated Ni |
| | PM30-10NB | NC | | | | | | |
| | PM30-10P | NO | PNP | | | | | |
| | PM30-10PB | NC | | | | | | |
|  | PM30-15N-S | NO | NPN | 15.0 mm | Non-flushed | 500Hz | 10~30 VDC | Cu plated Ni |
| | PM30-15NB-S | NC | | | | | | |
| | PM30-15P-S | NO | PNP | | | | | |
| | PM30-15PB-S | NC | | | | | | |
|  | PM30-15N | NO | NPN | 15.0 mm | Non-flushed | 500Hz | 10~30 VDC | Cu plated Ni |
| | PM30-15NB | NC | | | | | | |
| | PM30-15P | NO | PNP | | | | | |
| | PM30-15PB | NC | | | | | | |
|  | PM30-10S | NO | SCR | 10.0 mm | Flushed | 20Hz | 90~250 VAC | Cu plated Ni |
| | PM30-10SB | NC | SCR | | | | | |
|  | PM30-15S | NO | SCR | 15.0 mm | Non-flushed | 20Hz | 90~250 VAC | Cu plated Ni |
| | PM30-15SB | NC | SCR | | | | | |
|  | PM30-15N-P | NO | NPN | 15.0 mm | Non-flushed | 500Hz | 10~30 VDC | PBT |
| | PM30-15NB-P | NC | | | | | | |
| | PM30-15P-P | NO | PNP | | | | | |
| | PM30-15PB-P | NC | | | | | | |
|  | PM30-20N-P | NO | NPN | 20.0 mm | Non-flushed | 200Hz | 10~30 VDC | |
| | PM30-20NB-P | NC | | | | | | |
| | PM30-20P-P | NO | PNP | | | | | |
| | PM30-20PB-P | NC | | | | | | |
|  | PM30-15S-P | NO | SCR | 15.0 mm | Non-flushed | 20Hz | 90~250 VAC | |
| | PM30-15SB-P | NC | | | | | | |
|  | PM30-20N | NO | NPN | 20.0 mm | Non-flushed | 200Hz | 10~30 VDC | Cu plated Ni |
| | PM30-20NB | NC | | | | | | |
| | PM30-20P | NO | PNP | | | | | |
| | PM30-20PB | NC | | | | | | |
|  | PM30-10N-M12 | NO | NPN | 10.0 mm | Flushed | 500Hz | 10~30 VDC | Cu plated Ni |
| | PM30-10NB-M12 | NC | | | | | | |
| | PM30-10P-M12 | NO | PNP | | | | | |
| | PM30-10PB-M12 | NC | | | | | | |
|  | PM30-15N-M12 | NO | NPN | 15.0 mm | Non-flushed | 500Hz | 10~30 VDC | Cu plated Ni |
| | PM30-15NB-M12 | NC | | | | | | |
| | PM30-15P-M12 | NO | PNP | | | | | |
| | PM30-15PB-M12 | NC | | | | | | |

◆ Connecting method of AND & OR

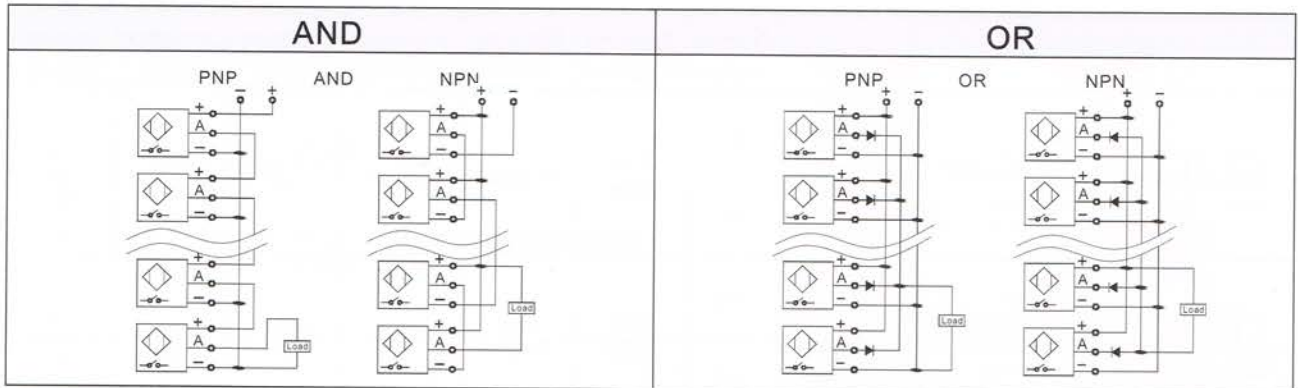

◆ Basic definition of Inductive proximity sensor / 基本定義

● Target / 標準檢測物

Which is a steel, 1mm thickness, square form with width equal to the diameter of the sensing surface, if the target is made of a different material, the sensing distance must be multiplied by the Correction factor.

標準檢測物是方型鐵片，厚度1mm，長寬等於感測器的感應面直徑。如果標準檢測物的材質不是鐵則感測距離須依右圖的修正係數修正。

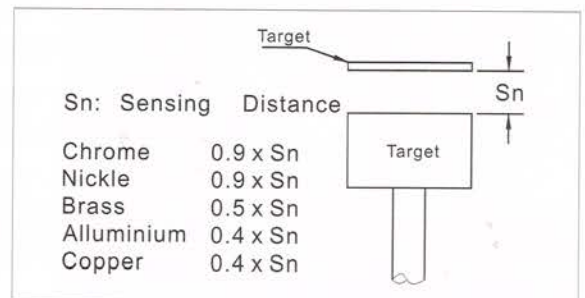

● Hysteresis / 應差

Hysteresis is the different distance between the operating points that the target is approaching and leaving the sensing area of the sensor, the value is expressed as a percentage of the sensing distance ($\Delta d/Sn\%$)

應差是感測器的動作點與復歸點的距離，一般是以動作點與復歸點的距離除以感應距離後以百分比表示。

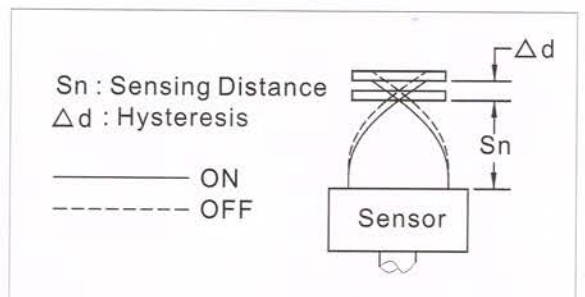

● Switch frequency / 響應頻率

It is the maximum response frequency per second, based on a pulse ratio 1 : 2, the sketch shows the condition of test.

響應頻率是以ON / OFF 比 = 1 : 2 的條件所測得每秒最高響應頻率。測試條件如右圖所示。

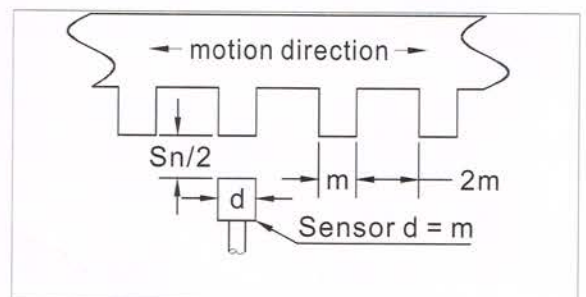

● Accuracy (Repetition) / 重複精度

Tolerance of operating position that sensor is certainly operated under the same condition.

在相同的條件下所測得的最大動作點與最小動作點的差值。

◆ Notice of installing for the Inductive proximity sensor / 安裝注意事項

● Flushed type / 埋入式

A proximity sensor can be flushed mounted in metal and surrounded by metal up to the level of the sensing face.

近接感測器可完全埋入金屬物即感應面四周可受金屬物包圍。

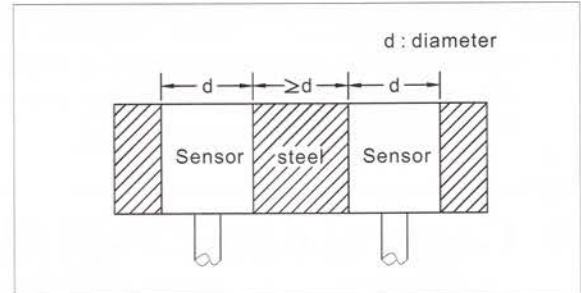

● Non-flushed / 非埋入式

A proximity sensor cannot be mounted in metal, clear zone of 3 times of the diameter of the sensing surface must be keep.

近接感測器感應面四周不可受金屬物包圍，淨空範圍必須是近接感測器感應面直徑的三倍距離以上。

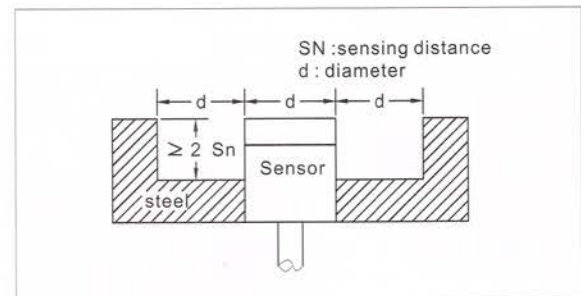

● Mutual interference / 互相干擾

To install the inductive proximity sensors of the same model by face to face or side by side, please set the minimum distance between the sensors larger than the diameter of sensor, to avoid the malfunction.

近接感測器不可以面對面或並排方式安裝，如果要以上述方式安裝務必保持近接感測器感應面直徑的一倍距離以上。

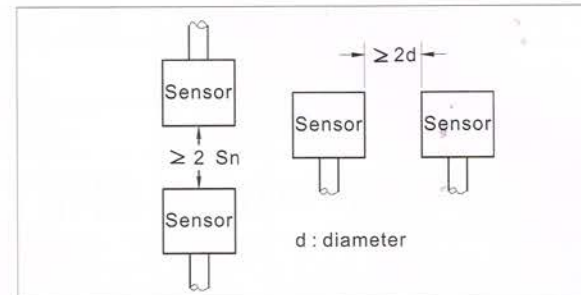

● Clamping torque / 鎖緊扭力

Be sure to set a spring washer when fixing the sensor, Don't tighten the mounting screw of PM series with a clamping torque higher than the right value.

安裝近接感測器時務必使用止滑墊圈以防止鬆脫。安裝Pm系列近接感測器時鎖緊扭力請勿超出最大扭矩值以免損壞近接感測器。

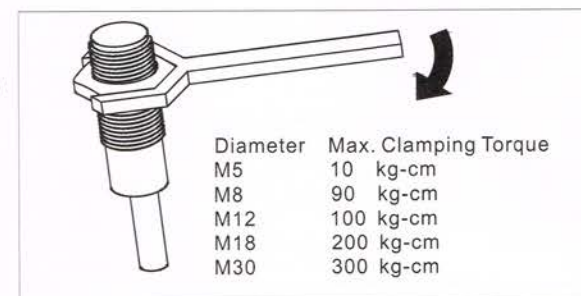

● Notice of Wiring / 配線注意事項

To avoid being influenced by noise, try best to separate the cable of the sensor from the power lines and high tension lines. if extend the sensor cable, please use a cable which diameter as same as that.

避免雜訊干擾，請儘量將感測器的電線與動力線或高壓線分離，不要綁在以起。如果要延長感測器的電線請儘量使用和感測器的電線相同規格的電線。